

**1/2 METER  
FRONTIER II  
JUMP STAND W/JIG  
STEEL STAND COMPLETE**

6' 68-209-586

8' 68-209-588



**CAUTION**

ALL MINIMUM WATER ENVELOPE DIMENSIONS FOR RESIDENTIAL INGROUND SWIMMING POOLS MUST MEET THE ANSI/NSPI-5 2003 AMERICAN NATIONAL STANDARD FOR RESIDENTIAL INGROUND SWIMMING POOLS (REFERENCED THROUGHOUT THESE ASSEMBLY AND INSTALLATION INSTRUCTIONS AS "ANSI/NSP-5 2003"). COMPLY WITH LOCAL GOVERNMENT REGULATIONS IF THEY EXCEED ANSI/NSPI STANDARDS.

All diving boards and related equipment are manufactured for inground swimming pools ONLY. The S.R. Smith Frontier II Jump Stands are designed to be easily transported and installed. Follow all instructions carefully and inspect closely to assure proper and safe installation.

PROPER INSTALLATION CANNOT BE OVERSTATED. IMPROPER INSTALLATION VOIDS S.R. SMITH'S WARRANTY AND MAY AFFECT THE SAFETY OF THE USER.

**ASSEMBLY AND INSTALLATION INSTRUCTIONS  
- PLEASE READ CAREFULLY -**



**WESTERN SALES AND MANUFACTURING PLANT  
CORPORATE HEADQUARTERS**

P.O. Box 400 • 1017 S.W. Berg Parkway  
Canby, Oregon 97013  
Phone (503) 266-2231 • Fax (503) 266-4334

**EASTERN MANUFACTURING PLANT**

105 Challenger Drive  
Portland, Tennessee 37148  
Phone (615) 325-0770 • Fax (615) 325-0775

[www.srsmith.com](http://www.srsmith.com)



**ATTENTION!  
THESE INSTRUCTIONS MUST REMAIN WITH STAND OWNER**

# 1/2 METER FRONTIER II JUMP STAND For 6' and 8' Frontier II Jump Boards

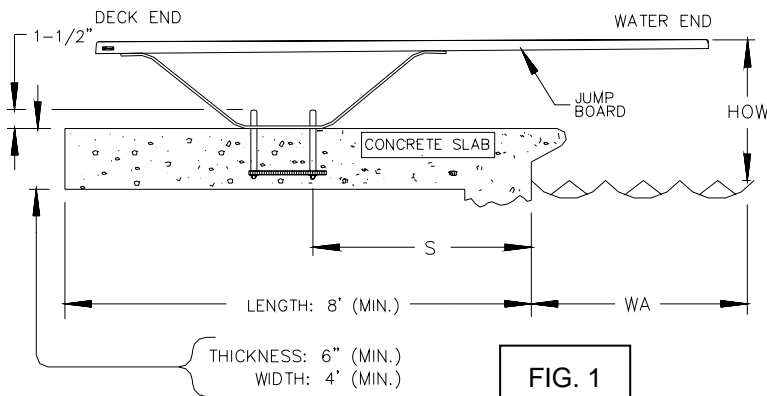

FIG. 1

**TIGHTENING SCHEDULE**  
SECURE BOARD TO STAND WITH  
MOUNTING HEX NUTS  
FIBERGLASS: 20-25 FT-LBS.

SECURE STAND TO JIG WITH:  
ANCHOR HEX NUTS  
40-50 FT-LBS.

S.R. SMITH CANNOT GUARANTEE  
CUSTOMER'S CONCRETE OR  
THICKNESS

**IMPORTANT NOTICE:**  
IT IS NECESSARY TO USE AN  
ANTI-SEIZE COMPOUND ON  
ALL STAINLESS STEEL  
HARDWARE. FAILURE TO USE  
ANTI-SEIZE COMPOUND MAY  
RESULT IN GALLING AND  
SEIZING OF THE HARDWARE.

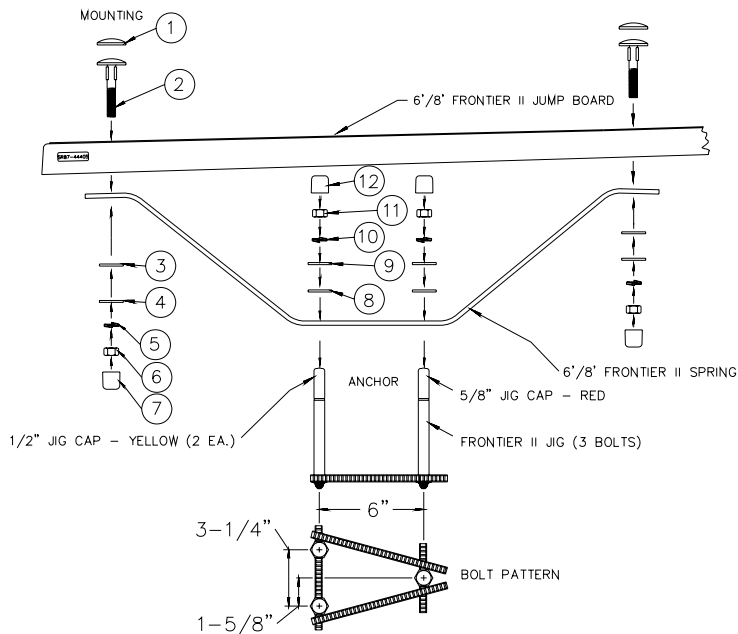

FIG. 2

## FRONTIER II MOUNTING

### BOLT KIT (69-209-032-SS)

1. STEP BOLT HEAD CAP – WHITE RUBBER (3 EA.)
2. 1/2" X 3" LG. STEP BOLT – S/S (3 EA.)
3. 1/2" X 1-1/2" ROUND NYLON WASHER (3 EA.)
4. 1/2" X 1-3/8" FLAT WASHER S/S (3 EA.)
5. 1/2" LOCK WASHER S/S (3 EA.)
6. 1/2" HEX NUT S/S (3 EA.)
7. 1/2" WHITE PLASTIC NUT CAP (3 EA.)

## FRONTIER II SPRING

### ANCHOR BOLT KIT (69-209-033-SS)

8. 5/8" X 1-3/4" NYLON PROTECTIVE WASHER (3 EA.)
9. 5/8" X 1-3/4" FLAT WASHER S/S (3 EA.)
10. 5/8" LOCK WASHER S/S (3 EA.)
11. 5/8" HEX NUT S/S (3 EA.)
12. 5/8" WHITE RUBBER NUT CAP (3 EA.)

# FRONTIER II JUMP STAND INSTALLATION CHART

Refer to Fig.1

Frontier II Stand with	Jump Board Length	ANSI/NSPI-5 2003 Pool Type	Distance For Setting Front Bolt of Jig From Water's Edge "S"	Min. Overhang ± 3" "WA**"	Max. Height of Board Above Water "HOW"
FRONTIER II	6'	I or II	26"	18"	20"
	6'	III	20"	24"	26"
	8'	III	34"	24"	26"
	6'	IV	14"	30"	30"
	8'	IV	28"	30"	30"
	8'	V	22"	36"	40"

**IMPORTANT:** The distance for setting the front bolt of the jig "S" from the waters edge is valid only if the minimum water depth is maintained at the tip of the board noted at point A in ANSI/NSPI-5 2003, Figure 3 and Table 1. If minimum water depth is not maintained the distance "S" must be adjusted accordingly.

\*WA DIMENSION IS VALID ONLY IN CONJUNCTION WITH MIN. DEPTH AT POINT A (SEE ANSI/NSPI-5 2003 FIGURE 3 AND TABLE 1) FOR POOL TYPE.

NOTE: When coping is used do not set front bolts of jig closer than 3" from the back edge of coping.

---

## INSTALLATION INSTRUCTIONS

---

BE SURE CONCRETE DECK SURROUNDING ANCHOR JIG COMPLIES WITH MINIMUM DIMENSIONS AS SHOWN IN FIG. 1 FOR POOL TYPE AND BOARD TO BE USED.

1. READ CAREFULLY the following, and pages A through E, which have been extracted from ANSI/NSPI-5 2003 and pay particular attention to Figure 3 and Table 1 set forth therein.
2. The Frontier II three-bolt jig should be set in accordance with the INSTALLATION CHART above and Fig. 1, with the "RED" capped bolt closest to the pool. This will give the desired minimum overhang. Board must be placed at deep end of pool on centerline.

**CAUTION:** Before pouring concrete around jig, check the bolt pattern of jig to Fig. 2. It is possible that they have become misaligned through shipping and handling.

3. Make sure bolts project out of concrete 1-1/2" with ample concrete depth below jig. Refer to Fig. 1 for minimum deck thickness, width and length.
4. When finishing deck surface, maintain a LEVEL DECK SURFACE where jig bolts project out so that the stand makes uniform contact with deck.
5. Before mounting stand, chisel away any excess concrete that may have built up around jig bolts and remove the red and yellow bolt caps.
6. Place stand over jig bolts and secure according to Fig. 2. Tighten ANCHOR hex nuts. Tighten all MOUNTING and ANCHOR hex nuts according to the TIGHTENING SCHEDULE in Fig. 1.
7. With Frontier II stand properly secured, select board size according to INSTALLATION CHART above. Take the White Rubber Step Bolt Caps and pullover the heads of the 1/2" x 3" long Step Bolts. When inserting Step Bolts through the board holes, tap with a rubber mallet in order to obtain a snug fit. Secure Frontier II jump board to stand according to Fig. 2 and tighten MOUNTING hex nuts.
8. The top surface of the diving board shall be level from side to side.

**ONLY ONE PERSON ON A JUMP BOARD AT A TIME, WITH A MAXIMUM WEIGHT OF 250 LBS.**

9. **IMPORTANT:** Refer to Table 2. Maximum diving board length, maximum height over water at point A and minimum cross section dimensions at point A and B shall be in accordance with Table 2 and Fig 3.

**Table 2- S.R. Smith Residential Pool Specifications**

Pool type	MAX. DIVING BOARD LENGTH	MAX. HEIGHT OVER WATER AT POINT A	CROSS SECTIONAL DIMENSIONS AT POINT A		CROSS SECTIONAL DIMENSIONS AT POINT B					
	DBL**	HOW**	F	G	H	J	K	L	M	N
0	<b>DIVING EQUIPMENT IS PROHIBITED</b>									
I	6' DB/6' JB	20"	2'-9"	5'-0"	4'-0"	7'-2 1/2"	7'-6"	6'-0"	3'-9"	2'-1 1/2"
II	8' DB/6' JB	20"	2'-9"	3'-10"	4'-2"	7'-2 1/2"	7'-6"	6'-8"	3'-9"	2'-1 1/2"
III	10' DB/8' JB	26"	2'-9"	4'-4 3/4"	4'-4 1/2"	7'-5 1/2"	8'-0"	6'-7"	3'-11 1/2"	1'-7 1/2"
IV	10' DB/8' JB	30"	2'-9"	5'-10 1/2"	3'-10"	7'-8"	8'-6"	8'-3"	5'-7"	2'-7"
V	12' DB/8' JB	40"	2'-9"	6'-2"	3'-11 1/2"	7'-9 1/2"	9'-0"	8'-2 1/2"	5'-9"	2'-1"

**NOTES:**

- \*\*1. ABBREVIATIONS: DBL=Diving Board Length, DB=Diving Board, JB=Jump Board, HOW=Height Over Water.
2. **IMPORTANT:** The walls of a Type I Pool, when defining the Maximum Diving Water Envelope shall be plumb.
3. All dimensions are minimum, except where noted as maximum.
4. One half (1/2) the width shown at each point shall be available on each side of the diving equipment centerline.
5. Minimum water depth under tip of diving board (Point A) is important to maintain.

**FIG.3**

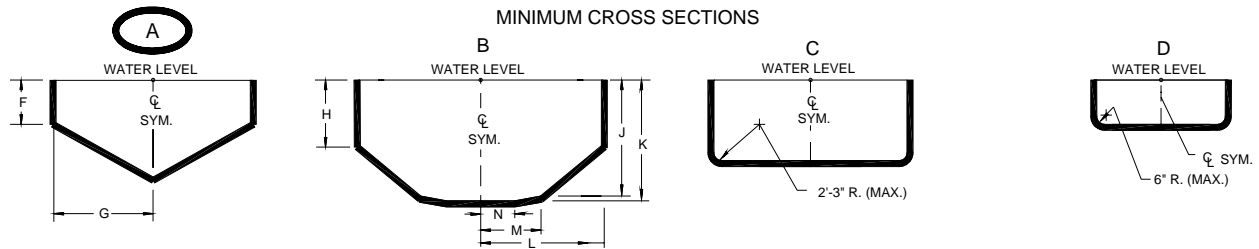

(SEE TABLE 2 FOR DIMENSIONS F-N)  
CROSS SECTION AT POINT A      CROSS SECTION AT POINT B      CROSS SECTION AT POINT C      CROSS SECTION AT POINT D

10. The top surface of the diving board from the deck end to the tip end shall be level or have an upward slope of 5/8" per foot (16 mm : 305mm) maximum. Elevation difference shall not exceed 6 inches (152mm) from the deck end to the tip of the board. There shall be no downward slope towards the water. The slope shall be measured using a level as shown in Fig. 4.

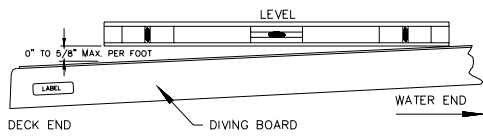

**FIG.4**

11. Minimum unobstructed headroom from the top of the manufactured diving equipment shall be provided for diving in accordance with Table 1.

<b>TABLE 1 MINIMUM HEADROOM ABOVE DIVING AREA</b>	
Pool Type	Minimum Headroom Above Diving Surface
I	12 feet (3.7 m)
II	12 feet (3.7 m)
III	13 feet (4 m)
IV	13 feet (4 m)
V	14 feet (4.3 m)

**ARTICLE 5 - POOL DIMENSIONS AND TOLERANCES**  
**EXTRACTED FROM ANSI/NSPI-5 2003**  
**AMERICAN NATIONAL STANDARD FOR RESIDENTIAL INGROUND SWIMMING POOLS**

**5.1 General requirements.** Design dimensions shall comply with specifications in this standard. The pool shall be constructed to these design dimensions within the tolerances listed in 5.1.1.

**5.1.1 Construction tolerances.** There shall be construction tolerances allowed on dimensional designs. The overall length, width and depth shall be limited to a tolerance of plus or minus 3 inches ( $\pm 7.6$  cm). All other dimensions shall be limited to a tolerance of plus or minus 2 inches ( $\pm 5.1$  cm), unless otherwise specified.

**5.2 Perimeter shape.** No limits are specified for shape of pools except that consideration shall be given to shape from the standpoint of circulation of the swimming pool water and safety to the user.

**5.3 Walls - requirements**

**5.3.1** Walls in the shallow area and deep area of the pool shall not slope greater than  $11^\circ$  (1:5 slope ratio) to a transition point. The transition point shall not be less than 2 feet and 9 inches (83.8 cm) below the waterline. See Fig. 1.

**5.3.2** As shown in Fig. 2, at the depths of (a) and (b), the walls are permitted to join the floor.

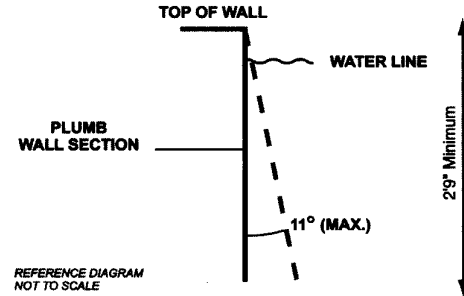
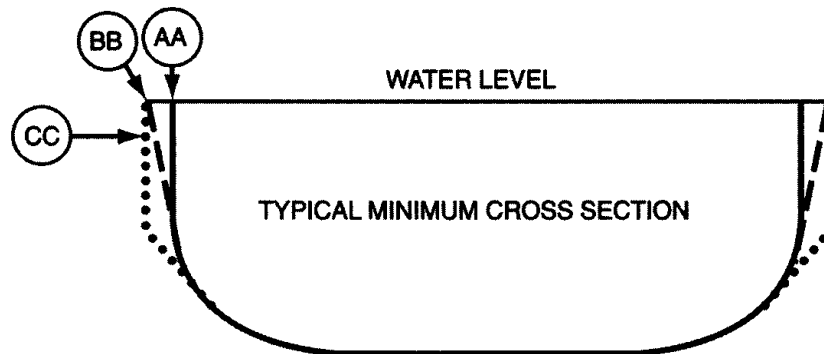
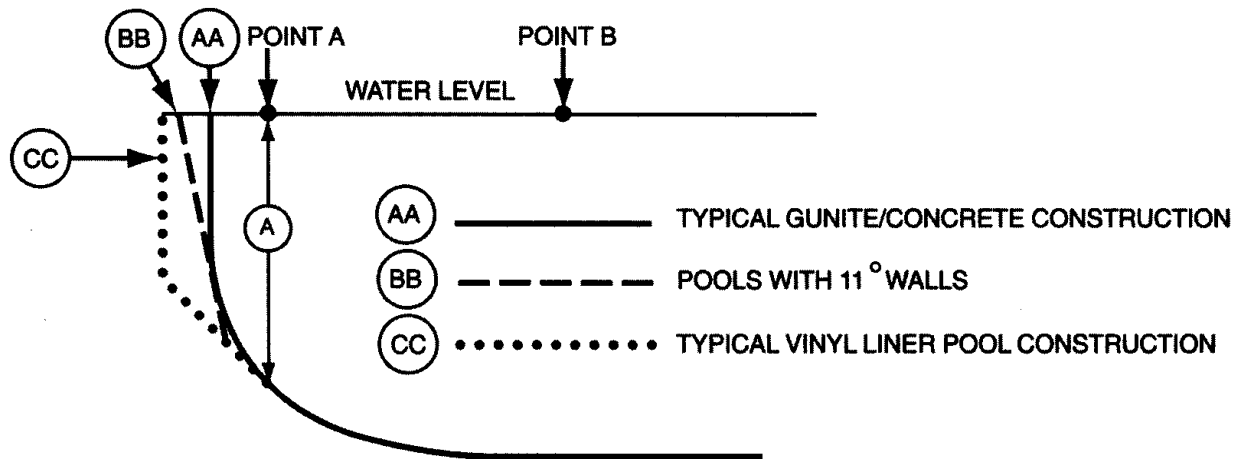

Figure 1- Maximum allowable wall slope



REFERENCE DIAGRAM  
 NOT TO SCALE

Figure 2- Typical pool design configurations

5.3.3 The walls of Type I pool, when defining the minimum diving water envelope, shall be plumb or outside of Type 1 water geometry. (See figure 3, table 1.)

5.4 Maximum allowable wall slope

5.4.1 Maximum allowable wall slope shall not slope greater than 11° from plumb.

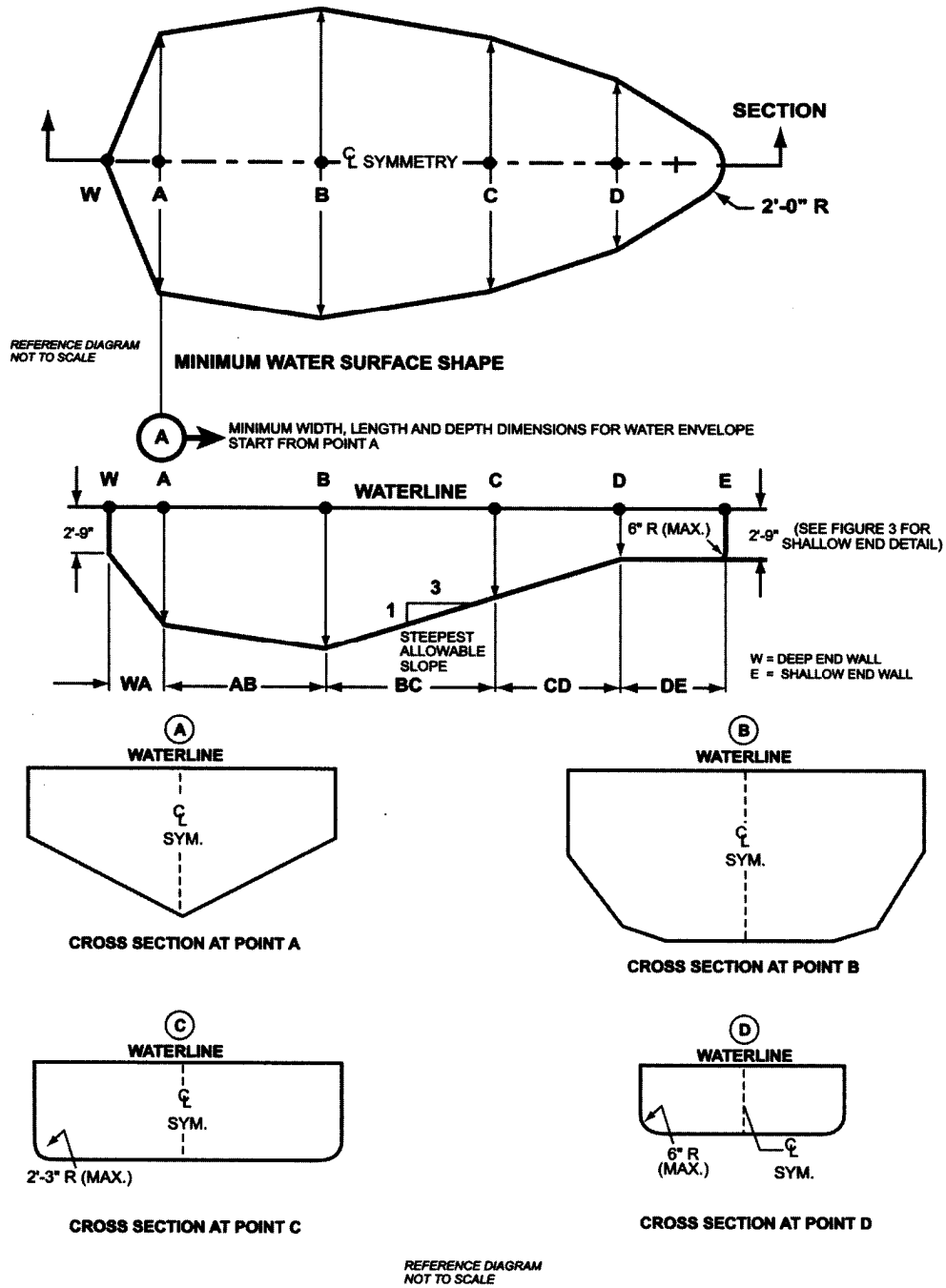

Figure 3- Minimum water envelope

**Table 1- Minimum water envelope**

Pool type	Minimum depths at point				Minimum widths at point				Minimum lengths between points					
	A	B	C	D	A	B	C	D	WA	AB	BC	CD*	DE	WE
O	Manufactured diving equipment is prohibited													
I	6'-0"	7'-6"	5'-0"	2'-9"	10'-0"	12'-0"	10'-0"	8'-0"	1'-6"	7'-0"	7'-6"	Varies	6'-0"	28'-9"
II	6'-0"	7'-6"	5'-0"	2'-9"	12'-0"	15'-0"	12'-0"	8'-0"	1'-6"	7'-0"	7'-6"	Varies	6'-0"	28'-9"
III	6'-10"	8'-0"	5'-0"	2'-9"	12'-0"	15'-0"	12'-0"	8'-0"	2'-0"	7'-6"	9'-0"	Varies	6'-0"	31'-3"
IV	7'-8"	8'-6"	5'-0"	2'-9"	15'-0"	18'-0"	15'-0"	9'-0"	2'-6"	8'-0"	10'-6"	Varies	6'-0"	33'-9"
V	8'-6"	9'-0"	5'-0"	2'-9"	15'-0"	18'-0"	15'-0"	9'-0"	3'-0"	9'-0"	12'-0"	Varies	6'-0"	36'-9"

**NOTE:**

- \*Minimum length between points CD may vary based upon water depth at point D and the slope between points C & D.
- Figure 3 drawings are not to scale.(For pool types, see Glossary.)

**5.5 Offset ledges**

**5.5.1** Offset ledges shall be a maximum of 8 inches (20.3 cm) wide.

**5.5.1.1** Offset ledges, located less than 42 inches (1067 mm) below waterline shall be proportionately less than 8 inches (20.3 cm) wide and fall within 11° from plumb, measured from the top of the waterline. See figure 4.

**5.6 Floor slopes.** Floor slopes shall be reasonably uniform and comply with 5.6.1 through 5.6.3.

**5.6.1** The slope of the floor from the shallow end wall towards the deep area shall not exceed 1 foot in 7 feet (30 cm: 213 cm) to the point of the first slope change as shown in figure 5.

**5.6.2** Changes in slope between shallow and deep areas shall be at a minimum water depth of 2 feet 9 inches (83.8 cm) and be at least six feet (182.9 cm) from the shallow end, except as specified in 6.3.

**5.6.3** The slope of the floor from the point of the first slope change toward the deep end shall not exceed 1 foot in 3 feet (30 cm: 91 cm).

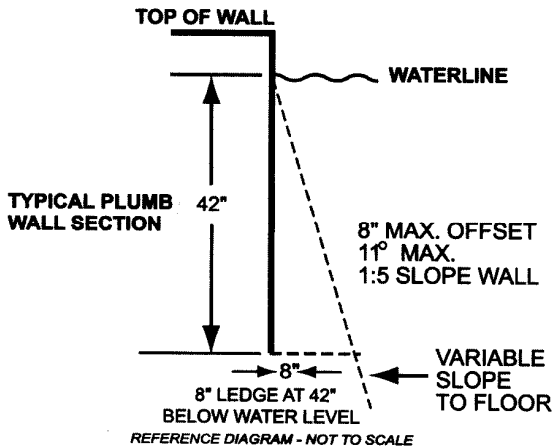

**Figure 4- Offset ledges**

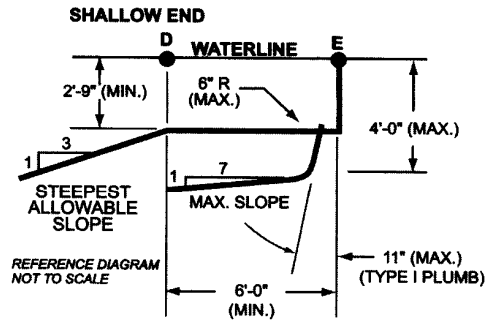

**Figure 5- Shallow end depths**

**5.7 Shallow end water depths.** Water depth in the shallow area shall be a minimum of 2 feet 9 inches (83.8 cm) except for those locations specified in 6.3 "Shallow End Detail for Beach and Sloping Entries." The water depth at the shallowest point shall not exceed four feet (121.9 cm) as shown in figure 5.

**5.8 Manufactured diving equipment for in-ground swimming pools (diving board/stand combination or manufactured platform)**

NOTE — For consumer safety information, warnings and education programs, See appendices D, E, and F.

**5.8.1** When manufactured diving equipment is installed, it shall conform to the specifications set forth in 5.8 through 5.9 and shall be located in the deep area of the pool so as to provide the minimum, dimensions as shown in 5.9.

**5.8.1.1** Manufactured diving equipment shall not be installed on Type 0 pools.

**5.8.2 Diving equipment.** Diving equipment shall be designed for swimming pool use and shall be installed in accordance with the manufacturer's specifications.

**5.8.2.1** Diving equipment installation and use instructions shall be provided by the diving equipment manufacturer and shall specify the minimum water dimensions required for each diving board and diving stand combination. They may refer to the water envelopes type of their choice by dimensionally relating their products to Point A on the water envelopes as shown in figure 3 and table 1, 5.9.1 through 5.9.3.

**5.8.2.2** Diving equipment shall be permanently labeled and affixed to the diving equipment or jump boards and shall include but not be limited to:

- manufacturer's name and address;
- date of manufacture;
- minimum water envelope required for each diving board and diving stand combination; and
- maximum weight limitations of the user as specified by the board manufacturer.

**5.8.2.3** Diving equipment shall have slip-resisting tread surfaces.

**5.9** Figure 3 contains suggested drawings and diagrams for minimum water envelope for swimming

pools designated type I - V. Individual pool types are shown in figure 3 and table 1.

**5.9.1 Location of point A.** Point A shall be defined as a point located on the minimum water envelopes.

**5.9.1.1 Point A.** Point A is a construction location nearest the deep end wall where the minimum water depth is satisfied.

**5.9.1.2** Point A as shown in figure 3 and table 1 shall be the reference point of origin for all dimensions defining the minimum water envelope.

**5.9.2** Type 0 pool (where diving is prohibited) shall not be limited in width, length, or water depth except as specifically provided for in this standard.

**5.9.3 Location of equipment and pool features in the minimum water envelope.** If the pool is designed for use with diving equipment, steps, pool stairs, ladders, underwater benches, special features and other accessory items shall be located outside the minimum water envelope. (See figure 6)

**5.9.4 Typical pool design configurations.** Vinyl liner, shotcrete, fiberglass and concrete constructions shall conform to, but are not limited to, the typical pool configurations shown in figure 2.

**5.10 Stationary diving platform(s) and diving rock(s).** Stationary diving platform(s) and diving rock(s) built on site shall be allowed to be flush with the wall and located in the diving area of the pool. Point A shall be in front of the wall at the platform or diving rock centerline.

NOTE — For consumer safety information, warnings and education programs, See appendices D, E, and F.

**5.10.1** The maximum height of the stationary diving platform or diving rock above the waterline shall be as follows:

- Pool Type I 42 inches (106.7 cm);
- Pool Type II 42 inches (106.7 cm);
- Pool Type III 50 inches (127.0 cm);
- Pool Type IV 60 inches (152.4 cm); or
- Pool Type V 69 inches (175.3 cm)

**5.10.2** Stationary diving platform(s) and diving rock(s) shall not be permitted on Pool Type 0.

**5.10.3** The diving equipment manufacturer shall specify minimum headroom above water.



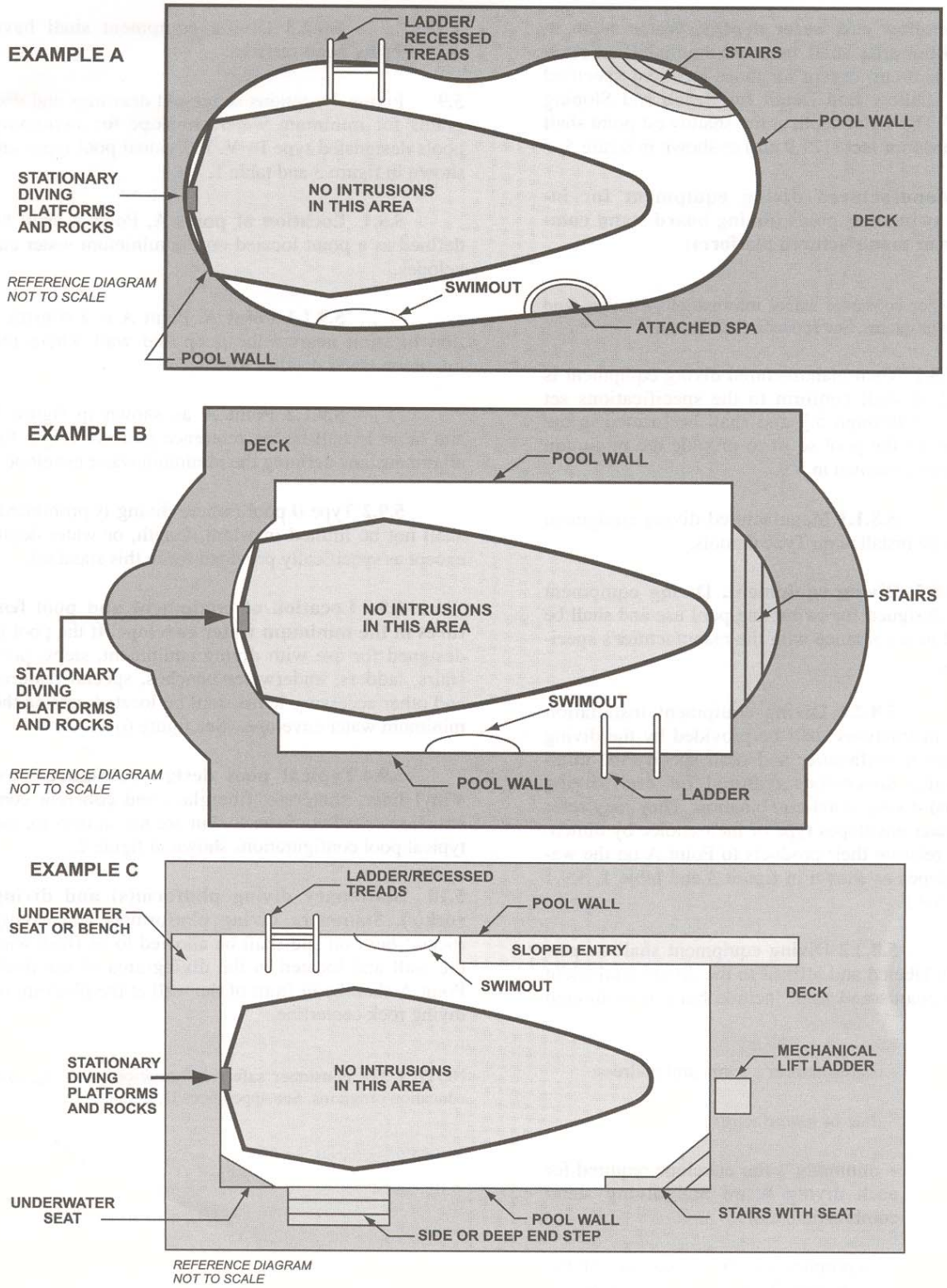

**Figure 6- Top view examples of accessory equipment and pool features prohibited in the water envelope**

For a copy of the complete ANSI/NSPI-5 2003 American National Standard for Residential Inground Swimming Pools contact:

National Spa and Pool Institute  
 2111 Eisenhower Avenue  
 Alexandria, VA 22314  
 Phone: (703) 838-0083  
 Fax: (703) 549-0493  
[www.nspi.org](http://www.nspi.org)