



pH
TEK

Proportional Feed System



Operating Instructions

INTRODUCTION

The pH-TEK is a chemical controller responsible for monitoring and correcting the pH levels in the swimming pool. The pH level in the pool is one of the most important factors in pool chemistry balance. Most red eyes and itchy skin are caused by poor pH maintenance. The pH-TEK is designed to keep the pH at a desired set-point between 7.0-7.6 . The chlorine is much more effective when the pH is optimally maintained.

IMPORTANT SAFETY INSTRUCTIONS

WARNING: The system must be installed at least 10 feet (3.0m) from the pool or spa wall.

WARNING: All electrical connections should be made by a qualified electrician.

WARNING: To reduce the risk of injury or electric shock, do not allow children to use this product.

WARNING: Do not connect this system to AC power until the installation is complete.

WARNING: Make sure the main pool timer circuit breaker is off when servicing the pH-TEK system.

WARNING: Do not operate with a damaged cord.

WARNING: Always use safety goggles and rubber gloves when handling acid.

INSTALLATION AND OPERATION

The pH-TEK system utilizes saddle clamps for installation. Before installing the saddle clamp, check to see if the pipe in your installation is 1.5 or 2 inch. The 1.5 inch saddle comes standard with this product. The 2 inch saddle (see picture on the right) is not included, but available from wherever the product was purchased.

1. When using the 2 inch saddle, it is important to place the rubber pad into the bottom half of the saddle in order to secure it properly to the pipe.
2. The pool system circuit breaker must be turned off (Fig.1) so that no electricity is running to the pool pump and no water is flowing.
3. The pH level in the swimming pool must be balanced (7.2-7.6) before installing and using the pH-TEK.
4. Locate an area on flat ground near the pool pump and timer which is easily accessible and place the pH-TEK tank assembly in this location.

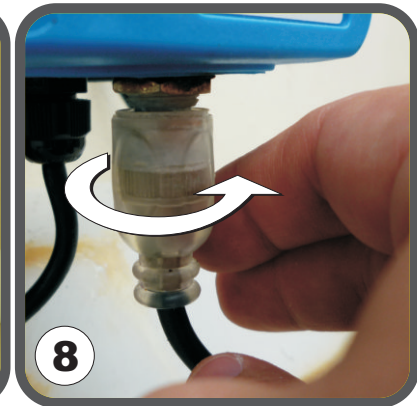
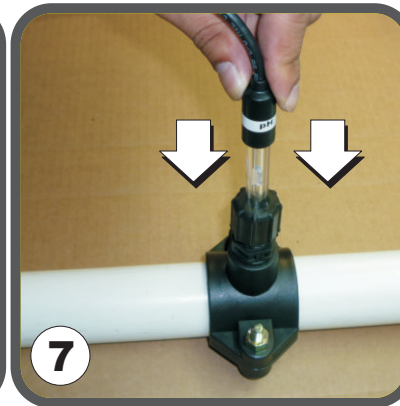
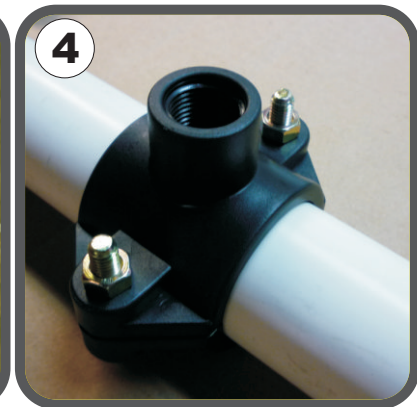
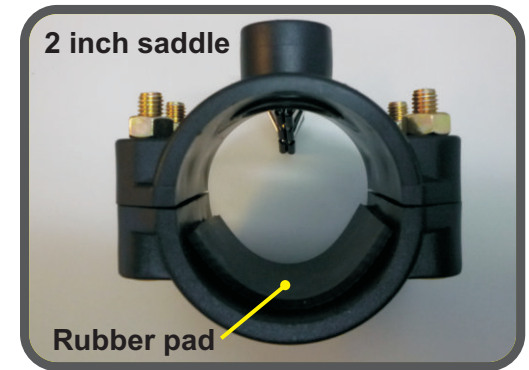

Probe Placement

5. Locate an area on the PVC pipe which is after the filter. This will be the area where the pH probe will be installed using a saddle clamp. Use the hole saw provided to drill a hole at the top center of the pipe (Fig.2, 3). Secure the saddle clamp tightly using the hardware provided (Fig.4). Take the probe holder and apply teflon tape to the thread (Fig.5) Secure probe holder by hand into the top of the saddle until the o-ring is compressed (Fig.6). Loosen the top of the probe holder and place the pH probe inside all the way down to the pH label (Fig.7). Secure the probe by hand tightening the top nut of the probe holder. Take the BNC connector at the end of the probe cable and secure it to the BNC connector at the bottom of the chemical controller (Fig.8).

INSTALLATION AND OPERATION

Acid Injection-to pool

6. Locate an area on the PVC pipe after all the pool equipment. This area should be located immediately before the water is returned to the pool. Use the hole saw provided to drill a ½ inch hole at the top center of the pipe (**Fig.9**). Secure the saddle clamp tightly using the hardware provided (**Fig.10**). Take the injection valve and apply teflon tape to the thread (**Fig.11**). Secure the injection valve by hand into the saddle so that the o-ring is compressed (**Fig.12**). Take the supplied tubing (**Fig.13**) and slide the nut onto one side. Next, slip the hose guard on the tube. Lastly, push the conic connection onto the end of the tube all the way until you cannot push anymore (**Fig.14**). Secure the nut by hand (**Fig.15**). Connect the other end of the tubing to the delivery nipple (down arrow) of the pump and secure nut to affix the tubing (**Fig.16**).



Adding Acid to the Chemical Tank

- Before adding acid, it is important to wear safety goggles and rubber gloves.
- Use fume free Sulfuric Acid only. It is best to dilute the acid with water in the chemical tank. Always add acid to water, not water to acid!
- Remove the black lid from the tank and add the water based on the amount of acid you plan to add. If you plan to add 2 gallons of acid, first add 2 gallons of water and then add the acid. This will create a 50% dilution and is ideal for the pH-TEK system.

INSTALLATION AND OPERATION

Electrical Installation

1. Turn off circuit breaker for external pump timer before making any electrical connections.
2. Using a grommet, secure the power cable and remove the knockout from the timer box. If you prefer to use a strain relief, locate an area in the timer box in order to drill a ½ inch hole for the strain relief (provided on power cable).
3. Disassemble the strain relief by removing the nut and run the power cable through the drilled hole in timer box. Pull necessary amount of cable through the hole and secure the strain relief using the nut provided.
4. Connect AC wires to the LOAD SIDE or to the same location as the circulation pump wires.

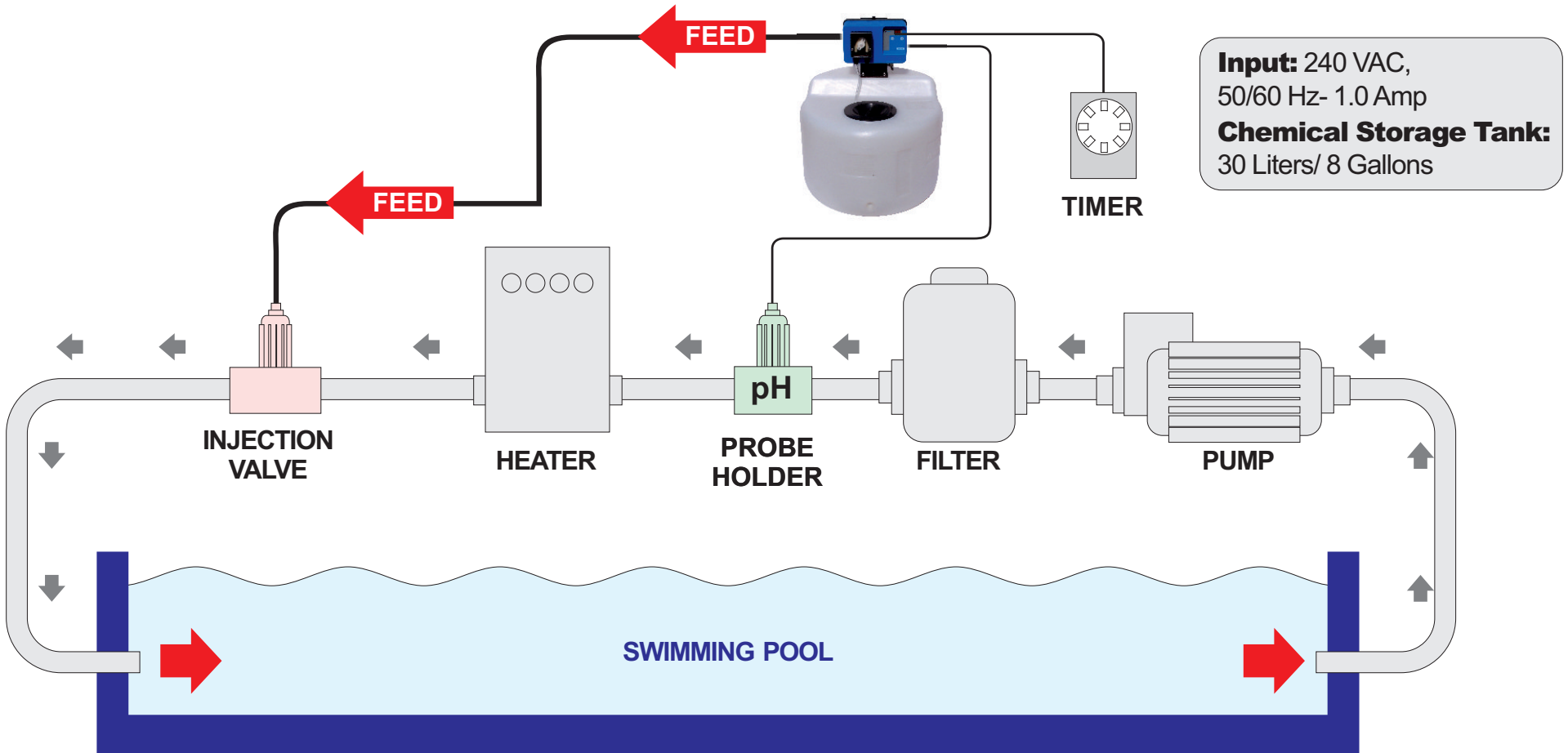
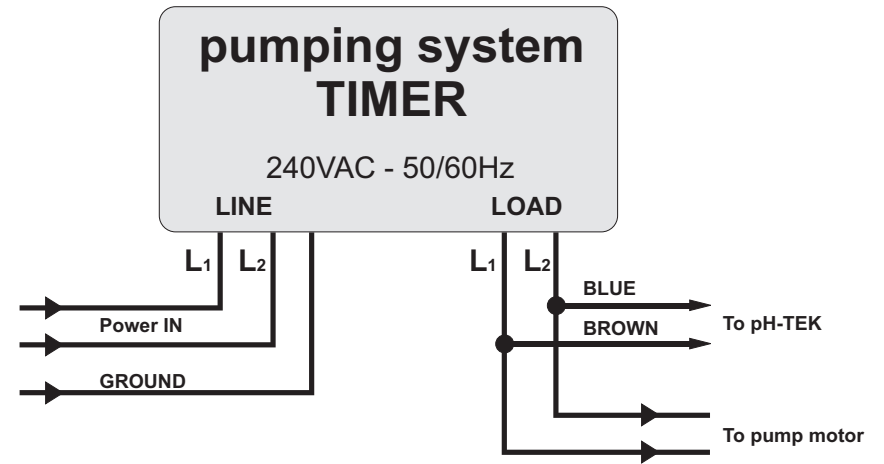

UNIT MAINTENANCE

Every Week

- Check pH level in pool using strips or DPD method.
- Inspect the Chemical container to make sure acid is present-minimum 2" from bottom of container at all times.
- Inspect the tubing for any damage.

Every Month

- Inspect chemical pump head tubing
- Measure Total Alkalinity

Beginning of each pool season / Every 3 months

- Calibrate pH probe (*see below*)

SETTING pH LEVEL

The pH level by factory default is set to 7.3 which is ideal. If you would like to change the factory setting, follow these steps:

1. Push and hold the SET button until you reach the desired set-point.
2. Once the value is selected, wait for 5 seconds without pushing any button and the value will be automatically stored.

NOTE: The pH value should only be set between 7.0-7.6 to maintain the correct pool chemistry.

PROBE CALIBRATION

1. Turn off the pool timer.
2. Remove the probe from the probe holder by removing the nut.
3. Pull the probe out of the probe holder and temporarily hang it in a secure place.
4. Take the rubber disc and replace into the probe holder and tighten the nut. This will prevent water from splashing out of the pipe during calibration.
5. Dip the probe into the 7.0 buffer solution and keep inside for 2 minutes.
6. Push and hold the CAL button for 3 seconds until the 7.0 value begins blinking. Once the calibration is finished, the display will stop blinking.
7. Remove the probe from the buffer solution and place it back in the injection holder the same way it was removed.

NOTE: If at the end of the calibration the display shows "rc", push the CAL button to exit. Follow steps 5-7 again. If the "rc" appears again, the probe should be replaced.

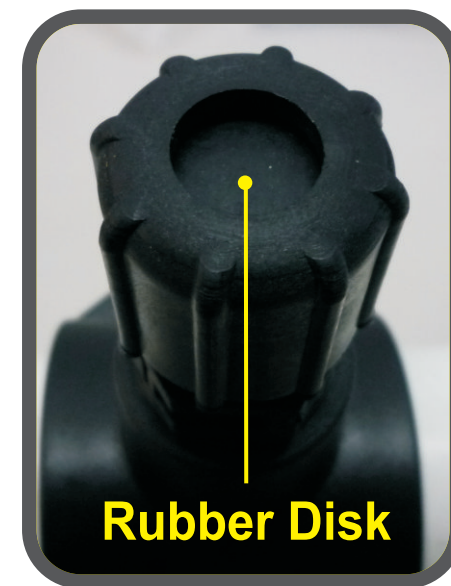
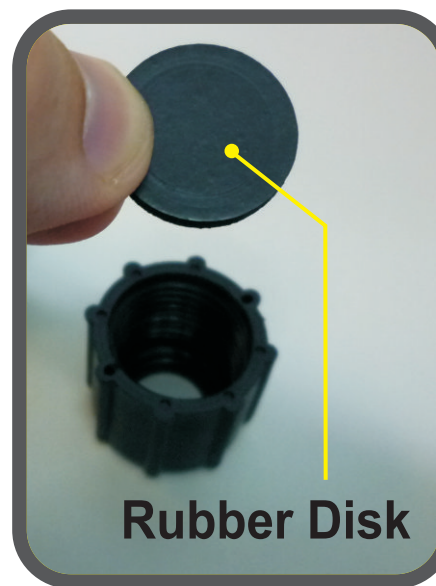

POOL AND SYSTEM MAINTENANCE

The pH-TEK system is designed to automatically control the pH levels in the pool. Test your water weekly or take a water sample to your nearest pool store. Maintaining these levels will maximize the life of this product.

Note: Alkalinity has a major effect on the pH level of the pool. The alkalinity must be kept in the proper range per the table below in order for the pH-TEK to maintain the correct pH level.

CHEMICAL	IDEAL RANGE	IDEAL TEST SCHEDULE	EFFECT OF LOW / HIGH LEVELS	CORRECTIVE ACTIONS
pH	7.2 to 7.8	Weekly	Low pH: (acidic) Equipment corrosion, eye/skin irritation, plaster etching, rapid chlorine consumption High pH: (basic) Scale formation, cloudy water, eye/skin irritation, poor chlorine effectiveness	Low pH: Add sodium carbonate or soda ash. High pH: Add sulfuric, muriatic, or dry acid .
Total Alkalinity	80 to 120 ppm	Weekly	Low TA: Eye irritation, sudden pH changes, stained/etched plaster and metal corrosion. High TA: Constant acid demand, difficulty in maintaining pH, and contributes to scale formation or cloudy water conditions.	Low TA: Add sodium bicarbonate. High TA: Add sulfuric or muriatic acid to the deep end of the swimming pool.

It is very important to note that pH is just one component of your pool chemistry. Please make sure your pool meets the optimum chemistry levels in the following Pool Chemistry Chart.

POOL CHEMISTRY CHART

FACTORS EFFECTING POOL CHEMISTRY	PREFERRED LEVELS
1 Salt (If using Chlorine Generator)	3000 to 4000 ppm (depends on manufacturer)
2 PH	7.2 to 7.6
3 Free Chlorine	1 to 3 ppm
4 Total Alkalinity	80 to 120 ppm based on the Saturation Index
5 Cyanuric Acid	60 - 80 ppm
6 Saturation Index	0 ± 0.3
7 Phosphates	0 ppm
8 Nitrates	0 ppm
9 Metals	0 ppm
10 Calcium Hardness	Depends on the pool finish

PARTS LIST



- 1 - Probe
- 2 - pH-TEK assembly
- 3 - Tubing
- 4 - Rubber Disc
- 5 - Injection Valve
- 6 - Probe Holder
- 7 - Buffer Solution
- 8 - Saddle Clamp (2 pcs)