



PROFESSIONAL SERIES HEAT PUMP POOL HEATERS



## NO ONE PUTS MORE INTO THEIR POOL HEATERS

---

Introducing the Raypak Professional series heat pump pool heaters, designed specifically for commercial properties such as apartments, condos, hotels, motels, schools, parks, community and high-end private pools. It's also the perfect heater for tough coastal weather conditions where salt air challenges durability. When your reputation is on the line every day, you've got to work smart and come prepared with strength, experience, and the guts to lead the way. In a word, it demands a Raypak Professional series pool heater.



## PROFESSIONAL GRADE PERFORMANCE

No other single compressor heat pump on the market today compares to the Raypak Professional 10353. With its industry leading 170kBTU output and 304 stainless steel cabinet, this is truly a commercial grade heat pump pool heater. Backed by a 2 year parts and labor commercial warranty, this is the heat pump your condo association has been looking for.

## PROFESSIONAL HERITAGE

---



Built by a company that only manufactures heaters dedicated to water heating, and refined through more than six decades of year-round demanding use in commercial boiler rooms, Raypak heaters embody the durability, longevity and flexibility that the true pool Professional expects. Many of the Professional pool heater features come directly from our commercial heating experience. This knowledge and experience is unmatched in the pool heating industry.

# TOUGH AND LEGENDARY DURABILITY JUST GOT BETTER

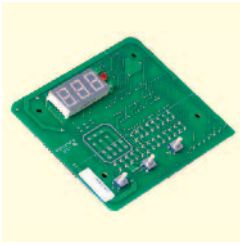

## MICROPROCESSOR

control is more precise than mechanical systems. It controls temperatures to within a half degree of the desired set point. Service technicians can easily view the service status of the unit.



## DIGITAL CONTROL

Our digital control is easy to use, and controls both pool and spa temperature settings as well as full diagnostics reporting. Fully compatible with most remote systems on the market today.



## SPIRAL TITANIUM TUBE

heat exchanger provides a corrosion-free waterway that can withstand the abuses of harsh pool chemistry. The spiral tube helps reduce deposit build-up and increases efficiency by performing a "scoop-and-lift" action.



## STAINLESS STEEL

It's specifically designed to take a beating in rough coastal climates where salt air can shorten the life of most outdoor appliances, with sleek, appliance grade 304 brushed stainless steel that is so attractive, you won't want to hide it behind your equipment wall.

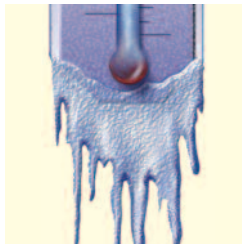

## RAPID DEFROST

Areas that are subject to lower ambient temperatures have a tendency to cause ice to build up on a heat pump's condensing coil. The Professional heat pump uses a patented refrigerant management system to rapidly defrost the heater.

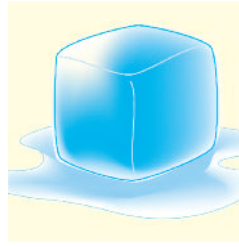

## COOLING FUNCTION

Raypak Heat-Cool units have a unique reversing valve which enables the heat pump not only to take the chill out of the water, but also to put it back in. Now you can cool your pool water during the hot summer months!



## SCROLL COMPRESSORS

by Copeland are reliable and operate at lower sound and vibration levels than reciprocating compressors. Durability is based on a robust design that contains only a few moving parts and it performs better with time: it "wears in," not out.

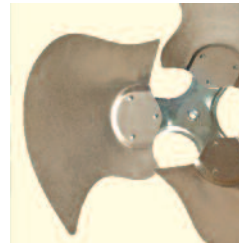

## SWEPT WING FAN

Specially designed "Swept Wing" fan blades operate more efficiently and generate minimal sound. Raypak heat pumps are packed full of premium quality components.



## ATTENTION TO DETAIL

was the main goal in designing the Professional heater. Every aspect was evaluated and changed to stainless steel when any question of corrosion was a concern.

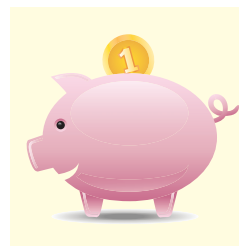

## ENERGY EFFICIENT

A heat pump operates at 5 to 6 times the efficiency of a standard gas, oil or electric pool heater. If you live in an area where your natural or propane gas costs have outpaced your electricity costs, the savings can be big.



## FLOW SWITCH

is standard equipment on the Raypak Professional. Having a flow switch eliminates pressure switch issues from elevated pools, above or below grade. Also, a flow switch is the only sure way to guarantee that the appliance has proper flow.



## WARRANTY

The Raypak Professional is unmatched in warranty for commercial applications: Two years parts and labor and ten years parts on the titanium heat exchanger tube. We stand behind what we believe in.

# Technical Data

## Professional Heat Pump Pool Heaters

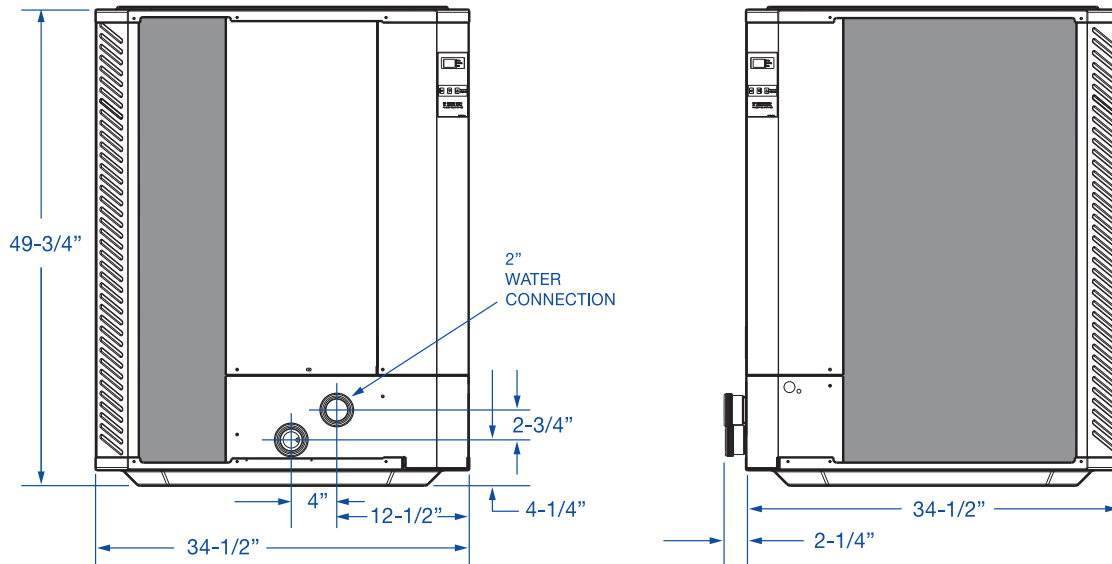

MODEL	PS10353ti	PS10354ti
Heat BTUH Output (80,80,80)*/AHRI 1160 (80,63,80)**	170,000/155,000	170,000/155,000
High Ambient C.O.P.	5.8/5.3	5.8/5.3
Low Ambient C.O.P.	4.0	4.0
Compressor	Scroll	Scroll
Refrigerant	R-410A	R-410A
Voltage	208/230V-3Ph-60Hz	460V-3Ph-60Hz
Minimum Circuit Ampacity	42	26
Maximum Breaker Size (Amps)	70	40
Electrical Input (kw)	8.6	8.6
Heat Exchanger	Titanium	Titanium
Water Flow (gpm)	15-60	15-60
Shipping Weight (lbs.)	445	450

\*Tested outside the scope of AHRI 1160 \*\*Tested to AHRI 1160 All models comply with Florida 4.0 minimum C.O.P. requirement.

### Model Designation

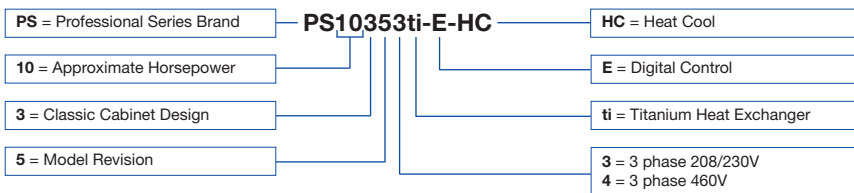

The Pool and Spa Heating Experts<sup>sm</sup>

Raypak, Inc. 2151 Eastman Avenue, Oxnard, CA 93030, (805) 278-5300. Fax (800) 872-9725 [www.raypak.com](http://www.raypak.com)