

VGB Series

The AquaStar line of suction outlet covers, compliant with the new Virginia Graeme-Baker Pool and Spa Safety Act (ANSI/APSP 16-2011 AND NSF 50-2008)

Features

For single or multiple drain use
(see installation instructions)

Single – 3" sump depth:
Floor: 145 GPM at 2.8 fps
Wall: 84 GPM at 1.7 fps

Single – Sumpless:
Floor: 140 GPM at 2.8 fps
Wall: 84 GPM at 1.7 fps

Floor/wall: 75 GPM at 1.5 fps

16.0 square inch opening

Additional sump versions
also available

#316 stainless steel screws

Manufactured from superior
UV-resistant engineered polymers

Meets or exceeds ANSI/APSP 16-2011
AND NSF 50-2008 national standards
and ASTM G154 UV testing

Listed with IAPMO R&T

24 per case







*Fits: AquaStar (all Pre-VGB 8" Models), American, Pentair, Color Match, Waterway and most Custom Molded (CMP)



Part # A8Rxxx

8" Round Solid Riser Ring also sold separately
part # A8RRxxx

STANDARD COLORS

	101		105
	102		108
	103		

OPTIONAL COLORS

	104		107
	106		

Also available with 8" Round Standard Sump p/n A8RSBxxx

Also available with 8" Round Standard Sump with Adjustable Collar p/n A8RSBACxxx

VGB 2008 Compliant

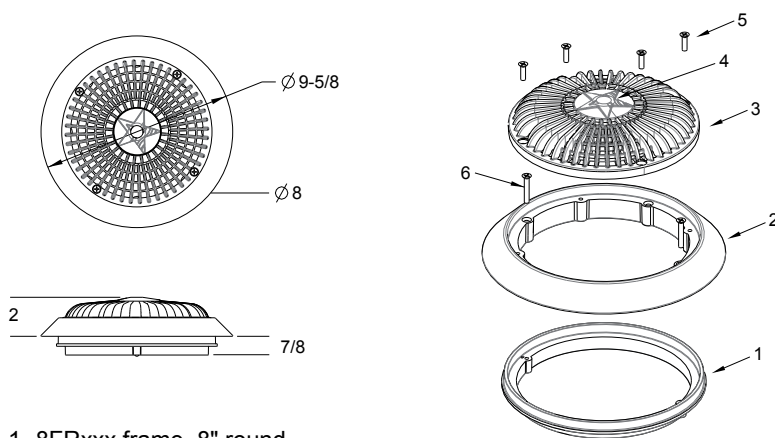

1. 8FRxxx frame, 8" round
2. A8RRxxx riser ring, 8" round
3. A8Rxxx super high flow 8" round anti-entrapment cover
4. VGB 2008 "color code" swimming man
5. 10x075-FPA #10 x 3/4" flat-head phillips type-a screw, 316 ss, qty 4
6. 10x125-FPA #10 x 1-1/4" flat-head phillips type-a screw, 316 ss, qty 2

ADDITIONAL PRODUCT CONFIGURATIONS FOR A8Rxxx

Double-Deep Sump

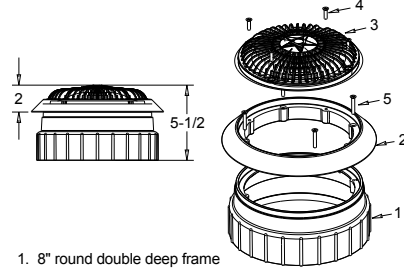

Part #
A8RxxxA
4 per case

1. 8" round double deep frame
2. Riser ring, 8" round
3. Super high flow 8" round anti-entrapment cover
4. #10 x 3/4" flat head phillips type-a screw, 316 ss, qty 4
5. #10 x 1-1/4" flat head phillips type-a screw, 316, qty 4

Dual-Port 2 1/2" Spigot x 2" Socket Deep PVC Sump

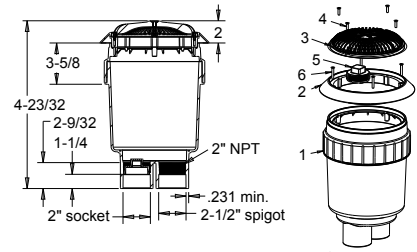

Part #
A8RxxxB
4 per case

1. Dual port 2-1/2" spigot x 2" socket deep PVC sump
2. Riser ring, 8" round
3. Super high flow 8" round anti-entrapment cover
4. #10 x 3/4" flat head phillips type-a screw, 316 ss, qty 4
5. 2" NPT port plug
6. #10 x 1 1/4" flat head phillips type-a screw, 316 ss, qty 4

4" Spigot Deep PVC Sump

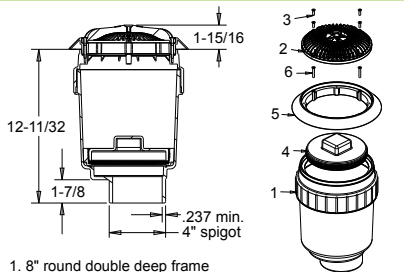

Part #
A8RxxxC
4 per case

1. 8" round double deep frame
2. Super high flow 8" round anti-entrapment cover
3. 10-32 x 5/8" flat head phillips machine screw, 316 ss, qty 4
4. 4" NPT plug, deep sump bucket
5. Riser ring, 8" round
6. #10 x 1 1/4" flat head phillips type-a screw, 316 ss, qty 4

4" Socket Deep PVC Sump

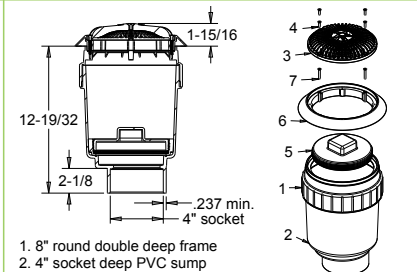

Part #
A8RxxxD
4 per case

1. 8" round double deep frame
2. 4" socket deep PVC sump
3. Super high flow 8" round anti-entrapment cover
4. 10-32 x 5/8" flat head phillips machine screw, 316 ss, qty 4
5. 4" NPT plug, deep sump bucket
6. Riser ring, 8" round
7. #10 x 1 1/4" flat head phillips type-a screw, 316 ss, qty 4

6" Spigot Deep PVC Sump

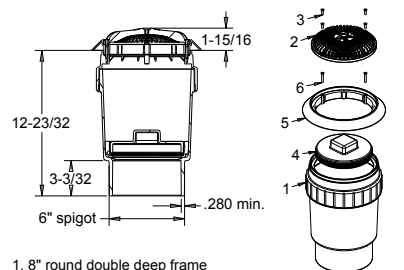

Part #
A8RxxxE
4 per case

1. 8" round double deep frame
2. Super high flow 8" round anti-entrapment cover
3. 10-32 x 5/8" flat head phillips machine screw, 316 ss, qty 4
4. 4" NPT plug, deep sump bucket
5. Riser ring, 8" round
6. #10 x 1 1/4" flat head phillips type-a screw, 316 ss, qty 4

6" Socket Deep PVC Sump

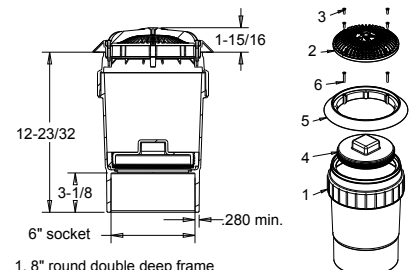

Part #
A8RxxxF
4 per case

1. 8" round double deep frame
2. Super high flow 8" round anti-entrapment cover
3. 10-32 x 5/8" flat head phillips machine screw, 316 ss, qty 4
4. 4" NPT plug, deep sump bucket
5. Riser ring, 8" round
6. #10 x 1 1/4" flat head phillips type-a screw, 316 ss, qty 4

8" Standard Sump

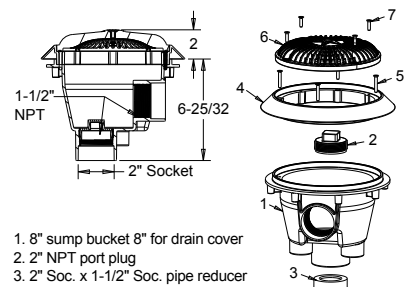

Part #
A8RSBxxx
8 per case

1. 8" sump bucket 8" for drain cover
2. 2" NPT port plug
3. 2" Soc. x 1-1/2" Soc. pipe reducer
4. Riser ring, 8" round
5. #10 x 1-1/4" flat head phillips type-a screw, 316 ss
6. #10 x 3/4" flat head phillips type-a screw, 316 ss
7. Super high flow 8" round anti-entrapment cover
8. #10 x 3/4" flat head phillips type-a screw, 316 ss

8" Standard Sump with Adjustable Collar

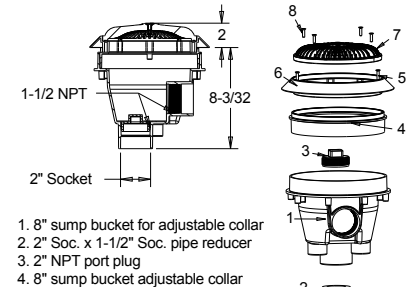

Part #
A8RSBACxxx
8 per case

1. 8" sump bucket for adjustable collar
2. 2" Soc. x 1-1/2" Soc. pipe reducer
3. 2" NPT port plug
4. 8" sump bucket adjustable collar
5. Riser ring, 8" round
6. #10 x 1-1/4" flat head phillips type-a screw, 316 ss
7. Super high flow 8" round anti-entrapment cover
8. #10 x 3/4" flat head phillips type-a screw, 316 ss