

8" ROUND STAR ANTI-ENTRAPMENT SUCTION OUTLET COVER, SOLID RISER RING AND MUD FRAME

VGB Series

The AquaStar line of suction outlet covers, compliant with the Virginia Graeme-Baker Pool and Spa Safety Act (ANSI/APSP 16-2011 and NSF/ANSI 50-2009a)

FEATURES

For single or multiple drain use
(see installation instructions)

Single – sumpless:

Floor: 140 GPM at 2.8 fps

Wall: 84 GPM at 1.7 fps

Single – 3" minimum sump depth

Floor: 140 GPM at 2.8 fps

Wall: 84 GPM at 1.7 fps

Floor/wall: 75 GPM at 1.5 fps

Floor/wall: 50 GPM at 1.0 fps

16.0 square inch opening

Additional sump versions
also available

Trademarked VGB compliance button
easily identifies VGB 2008 compliant
cover from on deck and underwater

#316 stainless steel screws

Manufactured from superior
UV-resistant engineered polymers

Meets or exceeds ANSI/APSP 16-2011 and
NSF/ANSI 50-2009a national standards
and ASTM G154 UV testing

Replace every five years from the date
of installation

24 per case

U.S. patent D621009

No sump required!



Part # A8Rxxx

Fits: AquaStar (all standard 8" models), American, Pentair, Color Match, Waterway and most Custom Molded (CMP)

STANDARD COLORS

□ A8R101 – White

■ A8R102 – Black

■ A8R103 – Light Gray

■ A8R104 – Blue

■ A8R105 – Dark Gray

■ A8R108 – Tan

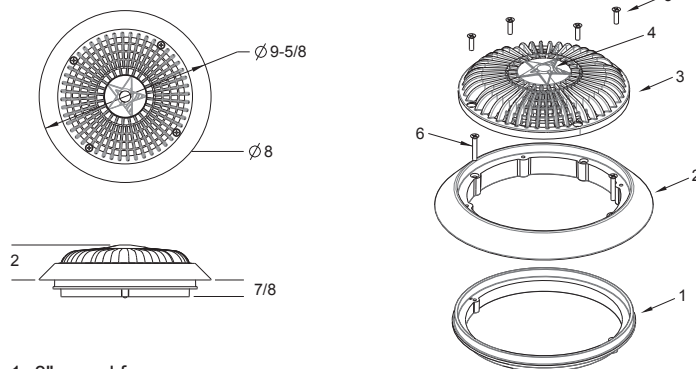

1. 8" round frame
2. 8" round riser ring
3. super high flow 8" round anti-entrapment cover
4. VGB 2008 "color code" swimming man
5. 10x075-FPA #10 x 3/4" flat-head Phillips Type A screw, 316 ss, qty 4
6. 10x125-FPA #10 x 1-1/4" flat-head Phillips Type A screw, 316 ss, qty 2

VGB 2008 Compliant

ADDITIONAL PRODUCT CONFIGURATIONS FOR A8RXXX

Double-Deep Sump

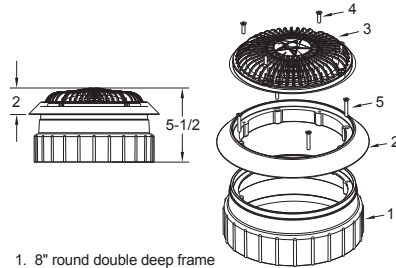

1. 8" round double deep frame
2. Riser ring, 8" round
3. Super high flow 8" round anti-entrapment cover
4. #10 x 3/4" flat head Phillips type-a screw, 316 ss, qty 4
5. #10 x 1-1/4" flat head Phillips type-a screw, 316 ss, qty 2

Part # A8RxxxA
4 per case

Dual-Port 2 1/2" Spigot x 2" Socket Deep PVC Sump

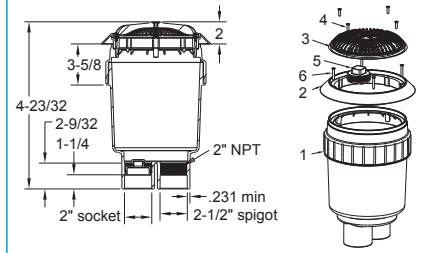

1. Dual port 2-1/2" spigot x 2" socket deep PVC sump
2. Riser ring, 8" round
3. Super high flow 8" round anti-entrapment cover
4. #10 x 3/4" flat head Phillips type-a screw, 316 ss, qty 4
5. 2" NPT port plug
6. #10 x 1-1/4" flat head Phillips type-a screw, 316 ss, qty 2

Part # A8RxxxB
4 per case

4" Socket Deep PVC Sump

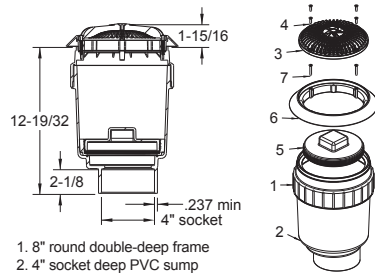

1. 8" round double-deep frame
2. 4" socket deep PVC sump
3. Super high flow 8" round anti-entrapment cover
4. 10 x 3/4" flat head Phillips screw, 316 ss, qty 4
5. 6" NPT plug
6. Riser ring, 8" round
7. #10 x 1-1/4" flat head Phillips type-a screw, 316 ss, qty 2

Part # A8RxxxD
4 per case

6" Socket Deep PVC Sump

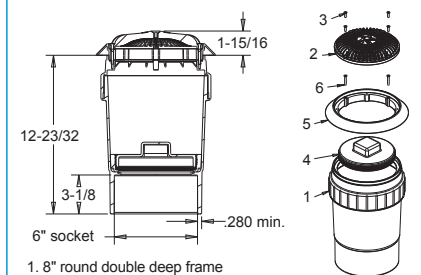

1. 8" round double deep frame
2. Super high flow 8" round anti-entrapment cover
3. 10 x 3/4" flat head Phillips screw, 316 ss, qty 4
4. 6" NPT plug
5. Riser ring, 8" round
6. #10 x 1-1/4" flat head Phillips type-a screw, 316 ss, qty 2

Part # A8RxxxF
4 per case

Standard ABS Sump with 1 1/2" NPT and 2" Socket

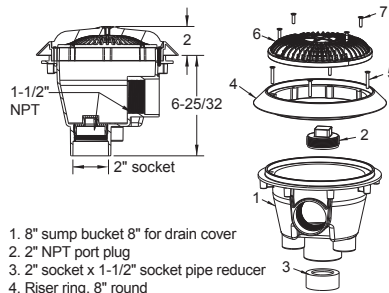

1. 8" sump bucket 8" for drain cover
2. 2" NPT port plug
3. 2" socket x 1-1/2" socket pipe reducer
4. Riser ring, 8" round
5. #10 x 1-1/4" flat head Phillips type-a screw, 316 ss, qty 2
6. Super high flow 8" round anti-entrapment cover
7. #10 x 3/4" flat head Phillips type-a screw, 316 ss, qty 4

Part # A8RSBxxx
8 per case

Standard ABS Sump with Adjustable Collar, 1 1/2" NPT, 2" Socket

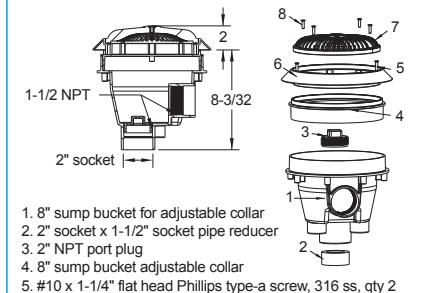

1. 8" sump bucket for adjustable collar
2. 2" socket x 1-1/2" socket pipe reducer
2. 2" NPT port plug
3. 2" NPT port plug
4. 8" sump bucket adjustable collar
5. #10 x 1-1/4" flat head Phillips type-a screw, 316 ss, qty 2
6. Riser ring, 8" round
7. Super high flow 8" round anti-entrapment cover
8. #10 x 3/4" flat head Phillips type-a screw, 316 ss, qty 4

Part # A8RSBACxxx
8 per case

Retrofit Skimmer Equalizer Kit

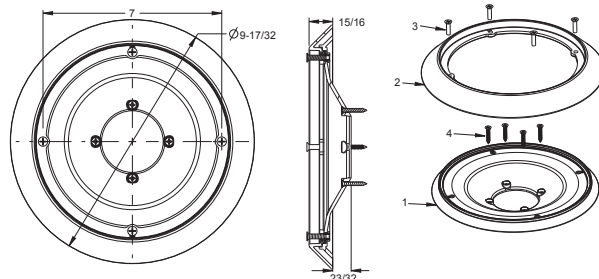

1. 8" to 4" adapter
2. Riser ring
3. #10-32 x 1-3/4" flat head Phillips screw, 316 ss, qty 4
4. #8 x 1" lg flat head Phillips screw, 316 ss, qty 4

Part # R8MHxxx
25 per case

Used with A8Rxxx to replace
LP8AVMHxxx and 8HPMHxxx
(sold separately)