

8" "For U Wade" Anti-Entrapment Suction Outlet Cover and Mud Frame

VGB Series

The AquaStar line of suction outlet covers, compliant with the new Virginia Graeme-Baker Pool and Spa Safety Act (ANSI/APSP 16-2011 AND NSF 50-2008)

Features

For single or multiple drain use
(see installation instructions)

Single – 3" sump depth
Floor: 110 GPM @ 2.2 fps
Wall: 106 GPM @ 2.1 fps

Floor/wall: 70.6 GPM at 1.5 fps

15.1 square inch opening

Additional sump versions
also available

#316 stainless steel screws

Manufactured from superior
UV-resistant engineered polymers

Meets or exceeds ANSI/APSP 16-2011
AND NSF 50-2008 national standards
and ASTM G154 UV testing

Listed with IAPMO R&T





36 per case





Part # 8FUWxxx

*Fits: AquaStar (All Pre-VGB 8" Models), American, Pentair, Color Match, Waterway and most Custom Molded (CMP) – at least two mud frame screws must be used to secure cover

STANDARD COLORS

	101		105
	102		108
	103		

OPTIONAL COLORS

	104		107
	106		

Also available with standard sump
for vinyl/fiberglass
p/n 8FUWSBVxxx

VGB 2008 Compliant

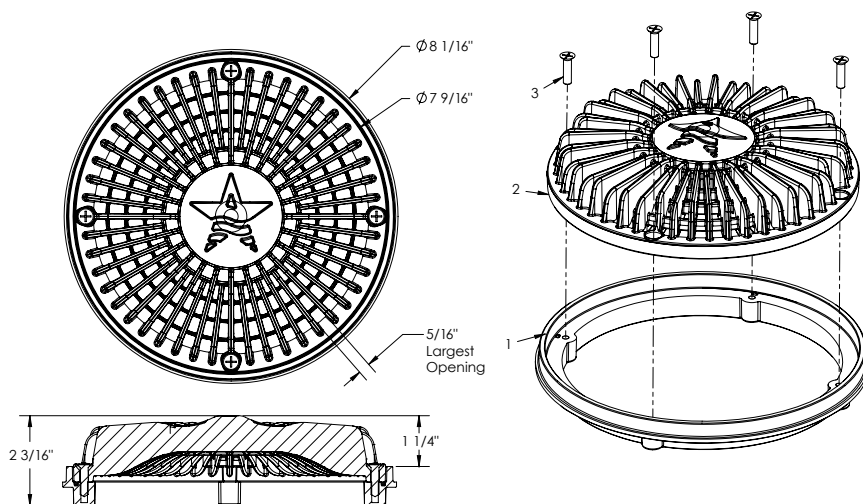

1. 8" round drain frame
2. 8" suction outlet cover
3. 10 x 3/4" flat head phillips type-a screw, 316 ss

ADDITIONAL PRODUCT CONFIGURATIONS FOR 8FUWxxx

Double-Deep Sump

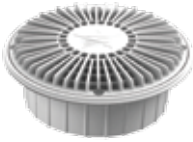

Part #
8FUWxxxA
4 per case

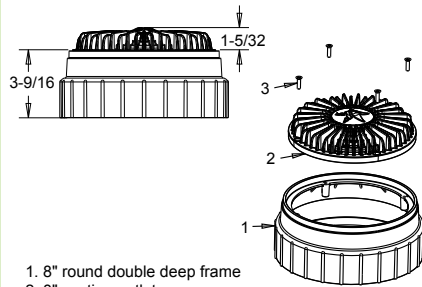

1. 8" round double deep frame
2. 8" suction outlet cover
3. #10 x 3/4" flat head phillips type-a screw, 316 ss, qty 4

Dual-Port 2 1/2" Spigot x 2" Socket Deep PVC Sump



Part #
8FUWxxxB
4 per case

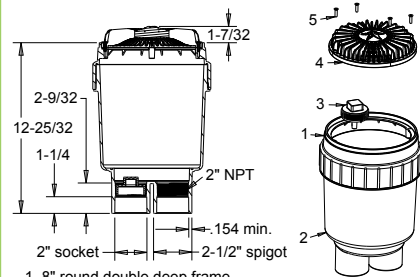

1. 8" round double deep frame
2. Dual port 2 1/2" spigot x 2" socket deep PVC sump
3. 2" tapered pipe thread plug
4. 8" suction outlet cover
5. #10 x 3/4" flat head phillips type-a screw, 316 ss, qty 4

4" Spigot Deep PVC Sump



Part #
8FUWxxxC
4 per case

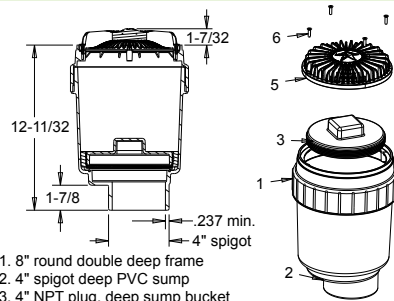

1. 8" round double deep frame
2. 4" spigot deep PVC sump
3. 4" NPT plug, deep sump bucket
4. Riser ring, 8" round
5. 8" suction outlet cover
6. #10 x 3/4" flat head phillips screw, 316 ss, qty 4

4" Socket Deep PVC Sump



Part #
8FUWxxxD
4 per case

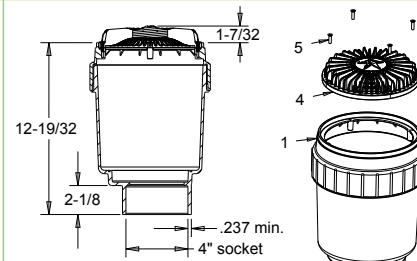

1. 8" round double deep frame
2. 4" socket deep PVC sump
3. Riser ring, 8" round
4. 8" suction outlet cover
5. #10 x 3/4" flat head phillips screw, 316 ss, qty 4

6" Spigot Deep PVC Sump



Part #
8FUWxxxE
4 per case

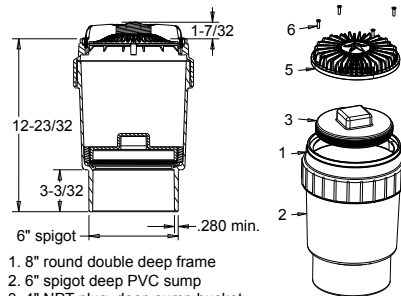

1. 8" round double deep frame
2. 6" spigot deep PVC sump
3. 4" NPT plug, deep sump bucket
4. Riser ring, 8" round
5. 8" suction outlet cover
6. #10 x 3/4" flat head phillips screw, 316 ss, qty 4

6" Socket Deep PVC Sump



Part #
8FUWxxxF
4 per case

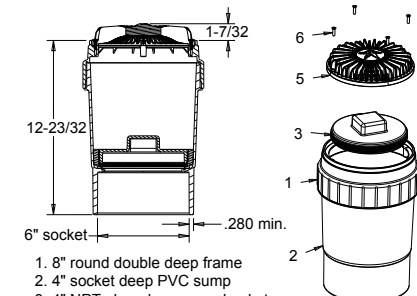

1. 8" round double deep frame
2. 4" socket deep PVC sump
3. 4" NPT plug, deep sump bucket
4. Riser ring, 8" round
5. 8" suction outlet cover
6. #10 x 3/4" flat head phillips screw, 316 ss, qty 4

8" Standard Sump



Part #
8FUWSBxxx
8 per case

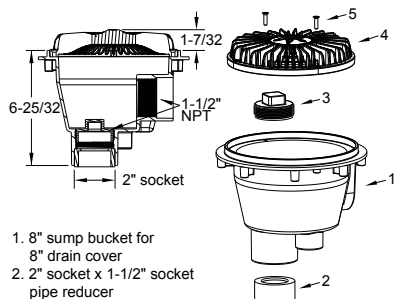

1. 8" sump bucket for 8" drain cover
2. 2" socket x 1-1/2" socket pipe reducer
3. 2" NPT port plug
4. 8" suction outlet cover
5. #10 x 3/4" flat head phillips type-a screw, 316 ss, qty 2

8" Standard Sump with Adjustable Collar



Part #
8FUWSBACxxx
8 per case

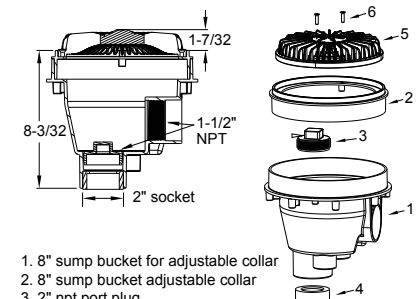

1. 8" sump bucket for adjustable collar
2. 8" sump bucket adjustable collar
3. 2" npt port plug
4. 2" socket x 1-1/2" socket pipe reducer
5. 8" suction outlet cover
6. #10 x 3/4" flat head phillips type-a screw, 316 ss, qty 2