

32" CHANNEL DRAIN PINHOLE SUCTION OUTLET COVER AND THREE-PORT PVC MANUFACTURED SUMP



**VGBA CERTIFIED
SPECIFICATIONS**

**Open Area
13.46in²**

For SOFA Specific Flow Ratings and
specifications please scan QR code or visit
www.aquastarpoolproducts.com/flowcode



FEATURES

All components meet or exceed APSP/ANSI/ICC-16 2017 and NSF/ANSI 50-2009a national standards and ASTM G154 UV testing exposure

Three ports: bottom 2½" OD, 2" ID S/S; inside 2" threaded FPT; two 2" threaded plugs included

Strong PVC sump does not require transitional glue

Designed for use with 2" hydrostatic relief valve part #HVxxx

Disposable plastic pre-gunite/plaster insert keeps debris out and retains sump shape during construction

#316 stainless steel screws

Manufactured from superior UV-resistant engineered polymers

Online product support including downloadable CAD files, General Certificate of Conformity, third-party certificate, installation instructions and more

Replace drain cover every five years from the date of installation

4 per case

U.S. patent 20140157510

Unblockable!

NEW Improved water stop and sump design



NEW Water Stop and Textured Sump

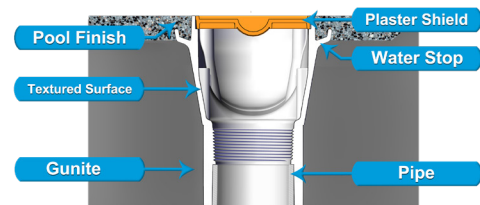

With sump (concrete pools)
Part # 32CDPHxxx

STANDARD COLORS

- 32CDPH101 – White
- 32CDPH102 – Black
- 32CDPH103 – Light Gray
- 32CDPH105 – Dark Gray

Also available as sump only,
32CDPxxx
4 per case

Also available cover only without
sump/frame, p/n 32CDPHNFxxx
24 per case

VGBA 2017 Compliant

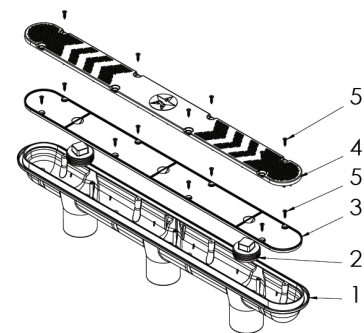
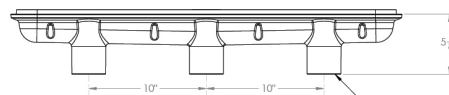
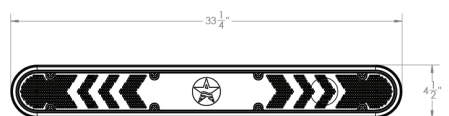

1. 32" Three-Port PVC Sump
2. 2" Tapered Threaded Pipe Plug, Qty 2
3. 32" Channel Drain Plaster Shield
4. 32" Channel Drain Pinhole Cover
5. 10 x 3/4" Flat Head Phillips, 316 SS, Qty 16

Plaster Shield and Screws to be Removed
After Gunite/Plaster Application

P 877-768-2717 F 877-276-POOL Outside the US: P +1-949-336-1940 F +1-949-336-1940
info@aquastarpoolproducts.com www.aquastarpoolproducts.com

32" CHANNEL DRAIN THREE-PORT MANUFACTURED PVC SUMP



VGB Series

The AquaStar line of suction outlet covers, compliant with the Virginia Graeme-Baker Pool and Spa Safety Act (APSP/ANSI/ICC-16 2017 and NSF/ANSI 50-2009a)

FEATURES

All AquaStar 32" channel drains are now available with PVC three-port manufactured sumps

Improved integrated patent-pending water stop around the edge of entire sump reduces leaks

Disposable plastic insert keeps debris out and retains sump shape during construction

Textured sump finish provides additional binding to plaster and gunite

Strong PVC sump does not require transitional glue

Designed for use with 2" hydrostatic relief valve part #HVxxx

4 per case

Improved water stop and sump design



NEW Water Stop and Textured Sump

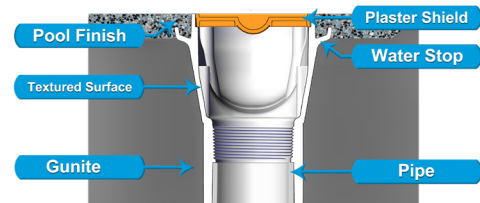

Part # 32CDPxxx

STANDARD COLORS

- 32CDP101 – White
- 32CDP117 – Medium Gray

Also available as plaster shield only
p/n PS109
10 per case

VGBA 2017 Compliant

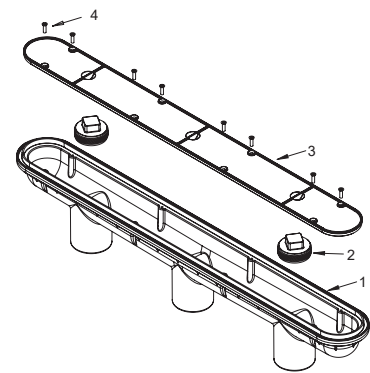
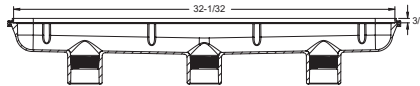
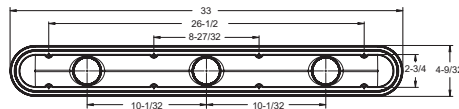
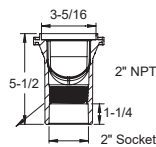

1. 32" Three-Port PVC Sump
2. 2" Tapered Threaded Pipe Plug, Qty 2
3. 32" Channel Drain Plaster Shield
4. 10 x 3/4" Flat Head Phillips, 316 SS, Qty 8

P 877-768-2717 F 877-276-POOL Outside the US: P +1-949-336-1940 F +1-949-336-1940
info@aquastarpoolproducts.com www.aquastarpoolproducts.com