

LUXOR® QUICK START GUIDE

The Luxor lighting controller manages groups of lights and light intensity at desired times. Two-wire connections power and communicate with all lights in a system.

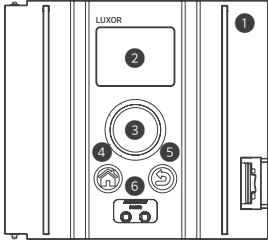

1. Facepack
2. LCD screen
3. Clickable scroll wheel
4. Home button
5. Back button
6. Fixture assignment ports

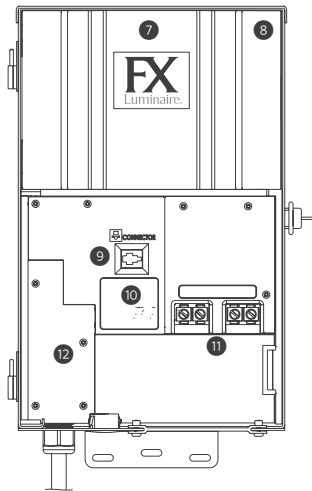

7. Core cover
8. Chassis
9. Facepack connection
10. Chassis LED
11. Terminal blocks
12. Fuse cover

Fixture Assignment

1. Enter assignment mode by inserting stripped wire leads into the assignment ports on the front of the Luxor controller facepack.

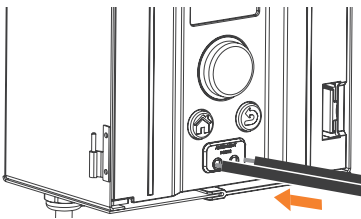

2. Select your desired group and press **Program**. If assignment fails, press **Program** again.



Controller Setup

1. Select **Setup** from the Home screen.



2. Enter the current Month, Day, Year, and Time (Hour, Minutes, Seconds). Then select Auto.
3. Select your desired Language.

Location Setup

1. Select your **Location** from the **Setup** screen.
2. Select your Region.*



3. Manually enter or select your **Map**.
4. Use the scroll wheel to navigate to the desired location and toggle between up/down and left/right.



*The time zone and longitude/latitude will automatically change with your selected region.

Wireless Control

Wireless Control Options:
Option A LAN connection
Option B Wi-Fi module

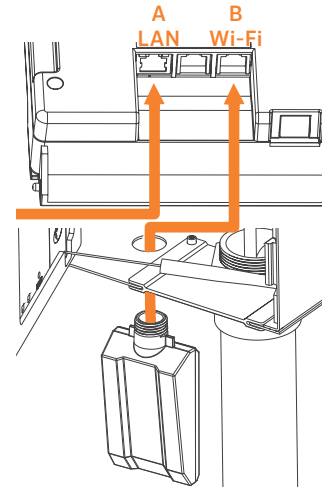

A. LAN Connection

1. Install a network cable into the LAN connector located on the back side of the Luxor facepack.
2. Select **Setup** from the **Home** screen.



3. Select **LAN**.
4. Confirm the **LAN** field displays "Connected."



Need help connecting?
Download the free Hunter Wi-Fi Wizard app.



Download on the
App Store

GET IT ON
Google Play

<https://hunter.info/WifiWizardApp>

FXLuminaire.

B. Wi-Fi Module

1. Install the WIFIMOD2 or WIFIMOD2RMT into the Wi-Fi connector on the back side of the Luxor facepack.
2. Select **Setup** from the Home screen.
3. Select **Wi-Fi**.



4. Scroll to the **Network** field and press the scroll wheel.
5. Select your desired network from the list of available networks.

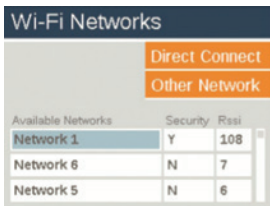

6. If necessary, enter your network password and press **OK**.

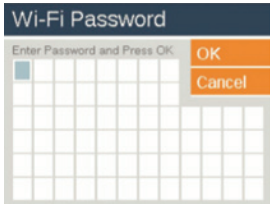

7. Confirm the Wi-Fi field displays "Connected."



Colors

1. Select **Color** from the Home screen.
2. Scroll to your desired color label (C1-C250).
3. Scroll to the **Color** field. Press the scroll wheel to enter the color on the **Color Selector** screen.

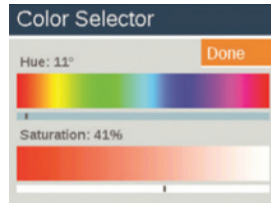

4. Scroll to the **Test Grp** field and select your desired group to test the color.

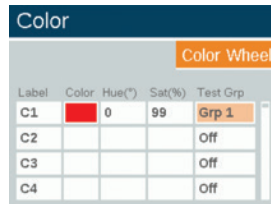

Color Wheel

1. Select **Color Wheel** from the **Color** screen.
2. Scroll to your desired **Color Wheel** label (CW1-CW10).

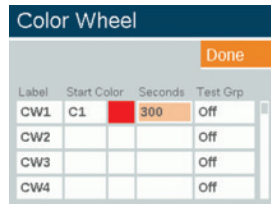

3. Select **Start Color**. Any color (C1-C250) can be used as a starting color.
4. Set your desired time interval (5 seconds to 300 seconds) for your **Color Wheel** cycle. The shorter the duration, the faster the cycle.

Themes

1. Select **Theme** from the **Home** screen.
2. Select your desired theme letter (A-AN).
3. Enter your desired Group(s), Color, and Intensities.
4. Press **Test** to temporarily turn on the desired Theme.

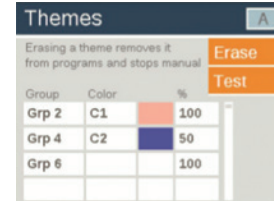

Programs

1. Select **Program** from the **Home** screen.
2. Select your desired **Program** (A-G).
3. Enter your desired event type (Sunset, Sunrise, or Time) in the Event field.
4. Enter the time you want the event to occur in the **Time** field.
5. Enter the **Group** or **Theme** that you want to be activated during the event.
6. For **Groups**, select the **Color** (if applicable).
7. Enter your desired intensity in the % field. Group events can be 1%-100%. Themes can be ON/OFF.



Best practice: To ensure all lights are turned off, set the last event in the Grp/Thm field to "ALL LIGHTS" and set the % field to OFF.