

BLUE LINE 32" AIR HOCKEY TABLE - NG1013T3

Spec Sheet

UPC code : 672875903108

2-color graphic on white 1/8" MDF play surface with approx. 741 holes in .75" square grid pattern over 1/2" air plenum that is baffled to control air flow.
Playing Surface Dimensions: 31.125" L x 15.125" W



2-piece plastic flap goal with manual scorer.
Pre-drilled holes in table must match goal holes.



4-color graphic on 1/2" MDF and black padded legs

Accessories: Includes two 2.5" strikers & two 2" pucks

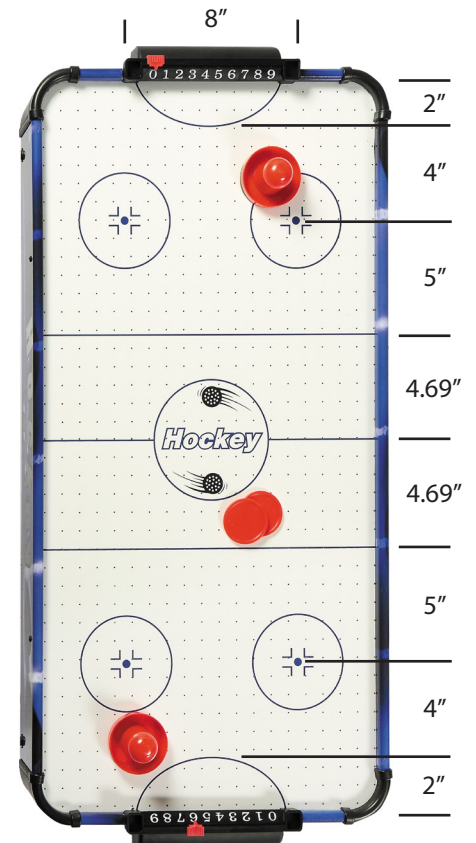

Tabletop graphic markings measurements



UL approved ON/OFF switch and fan



Securely mounted 5 blade axial fan AC120V 50/60 Hz 0.28A 24W 2P w/ a min. 6.5" square mounting board.

Both holes in table and leg must align when leg is flush against table for assembly.







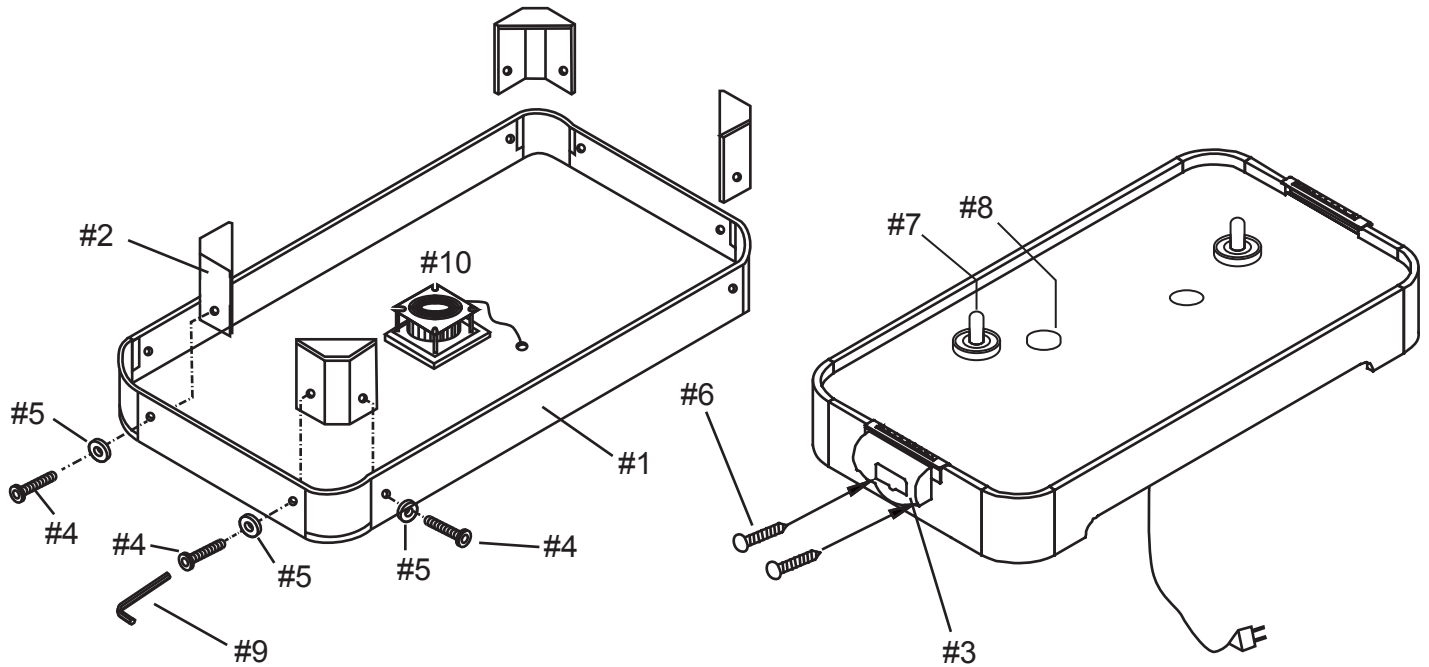

1/2" MDF (5.25"x3"x3") 90° padded legs should flush mount to table securely with 2 bolts, washers and nuts.

BLUE LINE 32" AIR HOCKEY TABLE - NG1013T3

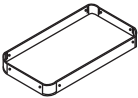

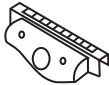

Spec Sheet



PARTS

<p>#1 NGP57753 32" x 16" x 4" 1/2" MDF</p>  <p>TABLE BODY 1 pc</p>	<p>#2 NGP57803 5.25" x 3" x 3" 1/2" MDF</p>  <p>LEG 4 pcs</p>	<p>#3 NGP57763 8" x 3.25" x 1.75" ABS Plastic</p>  <p>GOAL 2 pcs</p>	<p>#7 NGP5204 2" x 2.5" Dia. ABS Plastic w/ Felt Pad</p>  <p>STRIKER 2 pcs</p>	<p>#8 NGP5205 2" Dia. x 1/8" ABS Plastic</p>  <p>PUCK 2 pcs</p>	<p>#10 NGP50801 5 Blade Axial Fan Pre-installed on Table Body</p>  <p>BLOWER MOTOR 1 pcs</p>
---	--	---	---	---	---

HARDWARE PACK - NGP57773

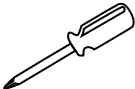
<p>#4</p>  <p>1" BOLT 8 pcs</p>	<p>#5</p>  <p>FLAT WASHER 8 pcs</p>	<p>#6</p>  <p>1/2" SCREW 4 pcs</p>	<p>#9</p>  <p>HEX WRENCH 1 pc</p>	<p>ADDITIONAL EQUIPMENT REQUIRED:</p>  <p>PHILLIPS HEAD SCREWDRIVER</p>
--	--	---	--	---