



### WARNINGS AND IMPORTANT SAFETY PRECAUTIONS

Be sure that the electrical system prior to installation conforms to all local codes and ordinances. A licensed or certified electrician must install the electrical system to insure that it follows all of the requirements of the National Electric Code (NEC). The electrician may need to consult the local building inspector for code interpretation before installing the 25650-100 wireless controller.

#### IMPORTANT NOTICE

Attention Installer: This manual contains important information about the installation, operation, and safe use of this product. This information should be given to the owner and/or operator of this equipment. When installing and using this electrical equipment, basic safety precautions should always be observed.

Read all safety precautions and important instructions before attempting any electrical wiring. Ensure that all power has been turned off at the power source. Failure to follow safety warnings and instructions can result in severe injury, death, or property damage. CMP recommends installation to be performed by a licensed professional.

### INTRODUCTION

Thank you for choosing the CMP 25650-100 series controller. If you haven't already done so, please take a moment to read our safety information. To fully enjoy the features of this controller, please read the entire manual before operating. Following these safety requirements should prevent any damage to your new controller.

## 1. PERFORMANCE PARAMETERS

### CONTROLLER

- Power input: 12 Volt DC
- Max Current: 5A x 3CH Max 15A
- Maximum load power: 180 Watts
- Change Mode: 32
- Scale Levels: 65536 steps/RGB (16Bits/CH)
- Control Function: 8 touch buttons
- Operating temp: -30°C to 55°C
- Dimension: L8.3 in. x W1.6 in. x H1.2 in.
- Weight(net): 180g

### REMOTE







- Power: Rechargeable 5 Volt DC built in Lithium battery
- Working Current: 30mA
- Working Frequency: 2.4 GHZ
- Battery Capacity: 1000mAh
- Charge Time: <4 hours
- Normal Usage Time: 30 days
- Number of charge cycles: 500
- Operating range: up to 90 feet (dependent on environment)
- Operating temp: -30°C to 55°C
- Dimension: 5.7"L x 2.2"W x 0.9"H
- Weight(net): 200g

## 2. KEY FEATURES

The remote control has 18 function buttons and 1 full-color touch circle. The controller has 8 touch buttons.

### HOW TO PAIR THE CONTROLLER WITH THE REMOTE

Press the "ON/OFF" key on the controller until you hear the "BEEP" sound, then press the "1" key on the remote to activate the connection between the controller and remote control. Press the "2" key to cancel the connection

Controller sign	Remote control sign	Button	Description
		<b>ON/OFF</b>	<b>ON/OFF:</b> Turn on/off the Controller.
	PAUSE II	<b>PAUSE</b>	<b>PAUSE</b> Press once to stay at current color Press again to resume color changing Press this button in 3 seconds, and the buzzer can be turned on or off
	MODE+ MODE-	<b>MODE+ MODE-</b>	<b>MODE+/MODE-</b> Press the keys to select next mode or back to previous mode.
	SPEED+ SPEED-	<b>SPEED+ SPEED-</b>	<b>SPEED+/SPEED-</b> Press the keys to quicken and slow color change speed
	BRT+ BRT-	<b>BRT+ BRT-</b>	<b>BRT+/BRT-</b> Press the keys to increase or decrease brightness, keep pressing to adjust brightness continuously
		<b>Full Color Touch Circle</b>	When touching the full-color circle, LED lights will show the same color as the circle.
	1 2 3 4 5 6 PLAY 7 8 9	<b>Nine DIY Keys</b>	Press a key for 3 seconds and the controller will save the current function mode automatically. Save up to 9 modes and save repeatedly as well. Press the "PLAY" key to cycle all saved modes. (this only plays the dynamic effects, static effects will be skipped automatically)

## 3. LIGHT MODES

No.	Mode	Description	No.	Mode	Description
1	Static red	brightness adjustable	17	Cyan fade out and fade in	speed/brightness adjustable
2	Static green	brightness adjustable	18	White fade out and fade in	speed/brightness adjustable
3	Static blue	brightness adjustable	19	RGB fade out and fade in	speed/brightness adjustable
4	Static yellow	brightness adjustable	20	Red Green color smooth	speed/brightness adjustable
5	Static purple	brightness adjustable	21	Red Blue color smooth	speed/brightness adjustable
6	Static cyan	brightness adjustable	22	Green Blue color smooth	speed/brightness adjustable
7	Static white	brightness adjustable	23	Red Yellow color smooth	speed/brightness adjustable
8	RGB skipping	speed/brightness adjustable	24	Green Cyan color smooth	speed/brightness adjustable
9	7 colors skipping	speed/brightness adjustable	25	Blue purple color smooth	speed/brightness adjustable
10	White strobe	speed/brightness adjustable	26	Green Yellow color smooth	speed/brightness adjustable
11	7 colors strobe	speed/brightness adjustable	27	Blue Cyan color smooth	speed/brightness adjustable
12	Red fade out and fade in	speed/brightness adjustable	28	Red Purple color smooth	speed/brightness adjustable
13	Green fade out and fade in	speed/brightness adjustable	29	Blue White color smooth	speed/brightness adjustable
14	Blue Fade out and fade in	speed/brightness adjustable	30	Yellow Purple Cyan color smooth	speed/brightness adjustable
15	Yellow fade out and fade in	speed/brightness adjustable	31	RGB color smooth	speed/brightness adjustable
16	Purple fade out and fade in	speed/brightness adjustable	32	full color smoothy	speed/brightness adjustable

### 3. INSTALLATION AND WIRING DIAGRAM

Connected to RGB module as an example

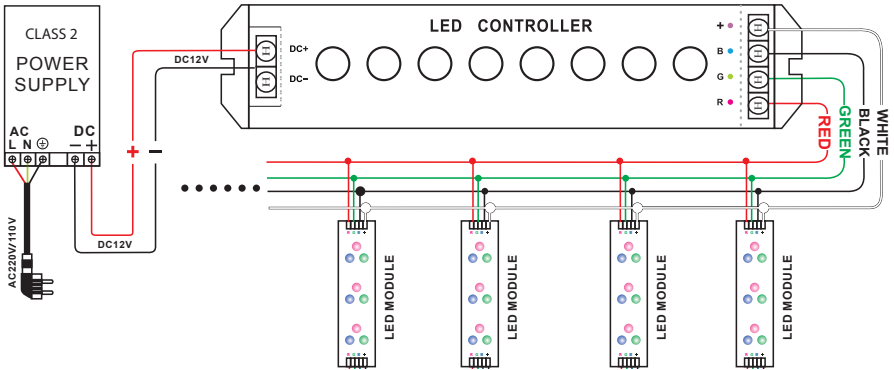

Note: Ensure all wire connections and polarities are correct before applying power.

#### CONTROLLER MOUNTING

*You must provide the controller enclosure*

- The enclosure or junction box must be installed per the National Electric Code (NEC) requirements as well as comply with any local codes and regulations
- All wire used from the controller box to luminaire must be in conduit.
- Min size of controller box must be 9" x 2" x 1.5".
- The enclosure must be non-metallic(plastic) to ensure adequate RF signals are achieved.
- For product longevity, ensure proper ventilation where both the controller and power supply may be mounted inside the same enclosure in elevated outdoor temperatures.



**DO NOT INSTALL ANY OTHER ITEM INSIDE CONTROLLER ENCLOSURE.**

State listed Class 2 Power Supply and Listed outdoor junction box will have to be purchased and installed.

CMP Plastic Outdoor Box  
for Controller Only  
25650-100-210

## 4. CHARGING METHODS

1. When charging, connect the USB cable to the mobile charger or a computer with USB interface. *The remote control must be turned on to charge.*
2. The blue indicator light flickers while charging, and will turn green when fully charged
3. No memory effect in the lithium battery of the remote control. Follow the standard charging procedure even for the first three charges. There is no need to over charge.
4. The red indicator light flickers when the battery is low and needs to be charged soon. Charging in low battery will effect battery life.

## 5. REPLACEMENT PARTS & DIMENSIONS GUIDE



COLORWHEEL REMOTE



LED CONTROLLER

P/N	DESCRIPTION
25650-100-300	REMOTE & CONTROLLER
25650-100-000	COLORWHEEL REMOTE
25650-100-100	CONTROLLER

