



OWNER'S MANUAL



Ozone Corona Discharge CD40, CD70, CD100

⚠ WARNING

FOR YOUR SAFETY - This product must be installed and serviced by a contractor who is licensed and qualified in pool equipment by the jurisdiction in which the product will be installed, where such state or local requirements exist. In the event no such state or local requirement exists, the maintainer must be a professional with sufficient experience in pool equipment installation and maintenance, so that all of the instructions in this manual can be followed exactly. Before installing this product, read and follow all warning notices and instructions that accompany this product. Failure to follow warning notices and instructions may result in property damage, personal injury, or death. Improper installation and/or operation will void the warranty.

Improper installation and/or operation can create unwanted electrical hazard which can cause serious injury, property damage, or death.

Table of Contents

Section 1. Important Safety Instructions	3
Section 2. Installation Requirements	5
2.1 Parts You Need	5
2.2 Tools Required	5
2.3 Power Requirements.....	6
2.4 Installation Location Requirements	6
Section 3. Installation.....	6
Step 1. Mount the Generator	6
Step 2. Connect Electrical Wiring	8
Step 3. Plumb the Injector Manifold.....	10
Step 4. Install a Water Check Valve (if applicable).....	15
Step 5. Perform a System Pressure Test (if applicable).....	15
Step 6. Perform the Ozone Flow Test.....	16
Section 4. Ozone Generator Operation	18
4.1 Pool Preparation Before Startup.....	18
4.2 Water Chemistry.....	18
4.3 System Startup and Operation	19
4.4 System Shut-Down and Winterizing	19
Section 5. Scheduled Maintenance.....	20
5.1 Check Power Supply to the Generator	20
5.2 Replace Ozone Modules	21
5.3 Verify Ozone Flow	21
5.4 Replace the Ozone Tube.....	21
Section 6. Troubleshooting	22
Section 7. Technical Support	24
Section 8. Replacement Parts	24

Section 1. Important Safety Instructions

READ AND FOLLOW ALL INSTRUCTIONS

All electrical work must be performed by a licensed electrician and conform to all national, state, and local codes. When installing and using this electrical equipment, basic safety precautions should always be followed, including the following:

DANGER

ELECTRIC SHOCK HAZARD Be sure to turn power OFF and disconnect from power source before any routine maintenance is performed. Failure to install in accordance with installation instructions could result in serious injury or death.

WARNING

ELECTRIC SHOCK HAZARD To reduce the risk of electrical shock, this device must be mounted such that it is inaccessible to a person in the pool.

WARNING

ELECTRIC SHOCK HAZARD Follow all applicable electrical codes.

WARNING

ELECTRIC SHOCK HAZARD - Install at least 5 feet (1.5 meters) from wall of pool using nonmetallic tubing. Install ozone generator no less than one (1) foot above maximum water level to prevent water from contacting electrical equipment. Install in accordance with the installation instructions.

- A pressure wire connector is provided on the outside of the unit, marked with “Bonding Lugs” to permit connection to a minimum No. 6 AWG (13.3 mm²) solid bonding conductor between this point and any metal equipment, metal enclosures of electrical equipment, metal water pipes, or conduit within five (5) feet (1.5m) of the unit or as needed to comply with local requirements.
- The Jandy Pro Series Ozone generator must be installed in an outdoor location, or indoors in a forced air ventilated room, and installed so that the orientation is exactly as shown in Figure 1. Install to provide water drainage of generator to protect electrical components.
- Mount the Jandy Pro Series Ozone generator so that it is inaccessible to anyone in the pool. Never attempt any servicing while unit is wet.
- Plastic ozone supply tubing is supplied with the Jandy Pro Series Ozone generator. Never replace this tubing with metal tubing.
- A green-colored terminal or a terminal marked G, GR, Ground, Grounding, or the  symbol is located inside the supply terminal box or compartment. To reduce the risk of electric shock, this terminal must be connected to the ground by the means provided in the electric supply service panel with a continuous copper wire equivalent in size to the circuit conductors supplying this equipment.

⚠ WARNING

Short-term inhalation of high concentrations of ozone and long term inhalation of low concentrations of ozone can cause serious harmful physiological effects. DO NOT inhale ozone gas produced by this device. Do not install this product indoors.

⚠ WARNING

At least two lugs marked "BONDING LUGS" are provided on the external surface or on the inside of the supply terminal box or compartment. To reduce the risk of electric shock, connect the local common bonding grid in the area of the hot tub or spa to these terminals with an insulated or bare copper conductor not smaller than No. 6 AWG.

⚠ WARNING

Do not store or use gasoline, chemicals or other flammable liquids or vapors near this or any other appliance. Do not permit children to use this product.

⚠ WARNING

The Jandy Pro Series Ozone Generator must be installed in an outdoor location, or indoors in a forced air ventilated room, and installed so the orientation is exactly as shown in Figure 1.

⚠ CAUTION

The Jandy Pro Series Ozone generator electrical connection is to be attached to the pool controls, be sure the pool controls are protected by a Ground Fault Circuit Interrupter (G.F.C.I.). If the Jandy Pro Series Ozone generator is connected to an independent electrical supply, then a G.F.C.I. must be installed between the Jandy Pro Series Ozone generator and the electrical supply. Refer to local codes for complete details.

⚠ CAUTION

Some vinyl pool liners with particular through-wall fittings may be incompatible with ozone. These fittings may cause fading of the vinyl liner where the ozone returns to the pool. A mixing degas vessel may be recommended to reduce the chance of minor fading of the vinyl at the pool's ozone return fitting. Zodiac Pool Systems, Inc. is not liable for fading of vinyl-lined pools.

SAVE THESE INSTRUCTIONS

Section 2. Installation Requirements

The Jandy Pro Series Ozone generators described in this manual are designed to provide the benefits of ozonated water in an environmentally safe and effective manner. The high quality, specially engineered components ensure efficient ozone output and reliable performance.

As a result of proper use of the Jandy Pro Series Ozone generators unpleasant effects of traditional chemical use are virtually eliminated. The Jandy Pro Series Ozone generators are safe and harmless to your equipment when installed properly.

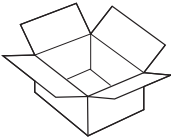

2.1 Parts You Need

Before starting the installation, check to ensure you have all parts listed below. If any parts are missing from the box, please call your local distributor for assistance.

- Ozone Generator
- Ozone Check Valve Assembly
- Pipe Cap (3/4")
- Tube Clamps (2)
- Flow Meter Assembly
- Tube Adapter
- Injector Manifold Assembly OR Mixing Degas Vessel (MDV)
- Mounting Screws (3), size 0.25 in. (6.3 mm) with anchors. (**NOT INCLUDED**. Choose hardware that is appropriate for the mounting surface.)



2.2 Tools Required

You will need the following tools:

- Phillips Screwdriver
- Scissors to cut tubing
- Quick Start Guide with drilling guide holes

2.3 Power Requirements

MODEL NUMBER	RATED VOLTAGE RANGE	MAX CURRENT	POWER FREQUENCY
CD40	120-240 VAC	0.17A	50-60 Hz
CD70	120-240 VAC	0.29A	50-60 Hz
CD100	120-240 VAC	0.40A	50-60 Hz

2.4 Installation Location Requirements

The generator must be mounted (as follows):

- In a clean, protected area, either indoors or outdoors (preferably out of direct sunlight) an ideal ambient temperature between 32°F - 120°F (0°C - 50°C)
- Out of reach of sprinklers or drainage spouts.
- With sufficient access for maintenance, tubing, and electrical wires.
- At least one foot above the maximum water level.
- So that the bottom of the enclosure is at least three (3) feet above ground, and such that the center of the enclosure is no more than six (6) feet above ground.

NOTE: The maximum height requirement is to allow an average height person to service comfortably.

Section 3. Installation

Step 1. Mount the Generator

NOTE: Remove and discard all foam packaging from inside the enclosure before mounting the unit.

1. Unscrew two (2) screws to open the enclosure door.
2. Locate the three mounting holes in the back of the enclosure (see Figure 1).

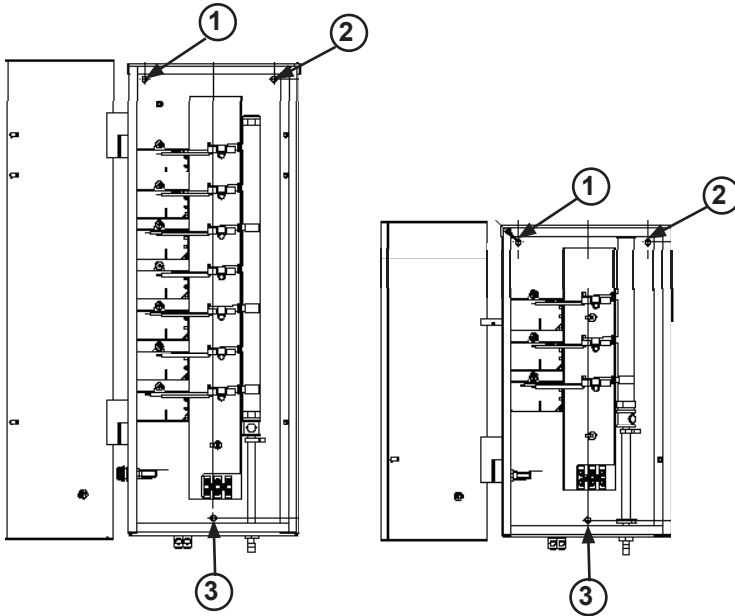

Figure 1. Location of the Mounting Holes

3. Align the drill guide against the mounting surface using a level. (The drill guide can be found on the long edge of the Quick Start Guide). Make pencil marks on the mounting surface through the paper guide holes.
4. Install two (2) screws through the top mounting holes.
5. Install the third screw through the bottom mounting hole.

NOTE: Mounting hardware must be driven until the head fully contacts the enclosure wall.

Step 2. Connect Electrical Wiring

IMPORTANT

Refer to the IMPORTANT SAFETY INSTRUCTIONS at the beginning of this manual for important electrical hazard information.

1. Turn off all electrical power to the system.
2. Connect the ozone generator to the “load side” of the filter pump relay.

NOTE: The ozone generator must not be powered on when the pump is turned off.

3. Install conduit fitting through one of the knockouts. There are three knockouts on the generator for a 1/2 in. conduit fitting (one on the back, two on sides).
4. Locate the Terminal Block inside enclosure. (Refer to wiring diagram on the label inside the enclosure door, see Figure 2.)

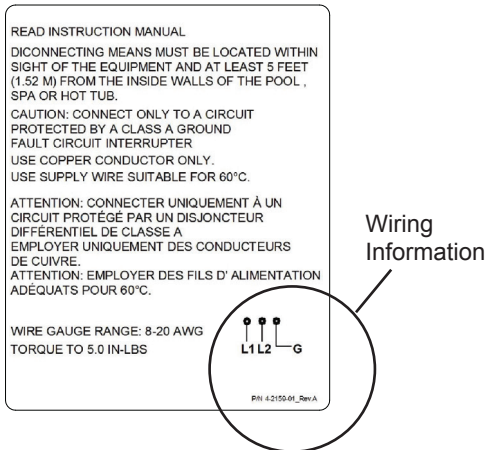

Figure 2. Wiring Information Label

5. For 120V, connect Line to L1, Neutral to L2, and Ground to the terminal block, as indicated on the label inside the enclosure door (see Figure 2).
6. Using a 6 AWG (13.3 mm²) conductor, connect the grounding lug on the bottom of the ozone generator to an appropriate earth contact.

7. Replace two (2) screws in the front cover.

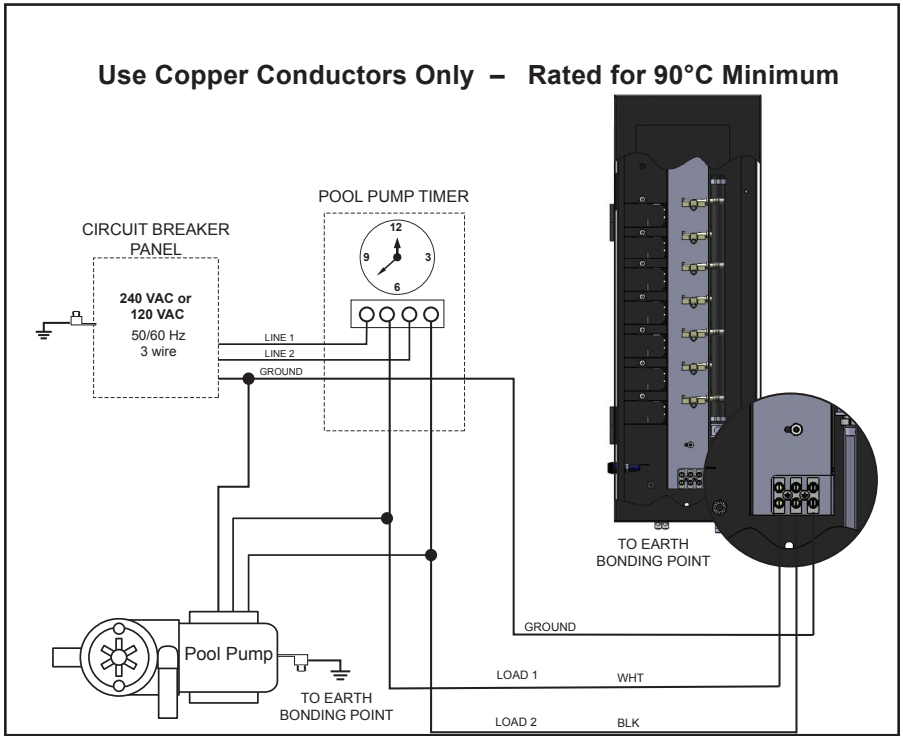

Figure 3. Electrical Connections

Step 3. Plumb the Injector Manifold

The injector manifold (Jandy Pro Series PN: CDIM) draws the ozone/air gas mixture out of the ozone generator and mixes it into the water leaving behind some undissolved gas bubbles. These bubbles can affect certain pool system components, so care must be taken to install the injector manifold in the right location.

Standard Configuration with Injector Manifold

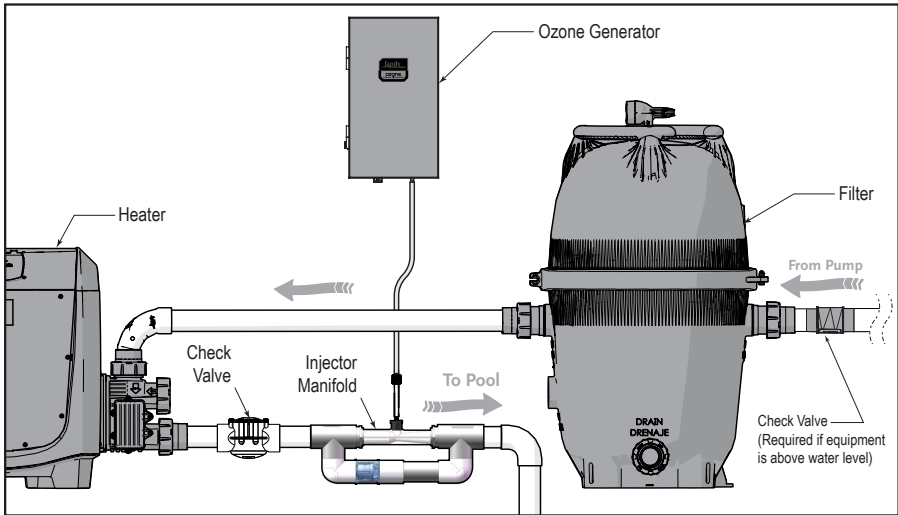

Figure 4. Plumbing Connections with Injector Manifold

In most standard pool equipment configurations, the injector manifold is installed in the pool's main return line after all other pool equipment (pump, filter, heater, and cleaner). See Figure 4. For alternate configurations, such as in-floor cleaning system, salt chlorinator, etc. see Figure 6.

Injector Manifold Orientation

The preferred installation for plumbing the injector manifold is horizontal with the ozone check valve facing upward (Figure 4).

If there is not sufficient space, the injector manifold may be installed either vertically or horizontally with the ozone line check valve facing downward.

Vertical Installation: The ozone check valve must be above the injector port. Ensure the hose is cut for as little slack as possible so that water does not collect in the hose (see Figure 5).

Horizontal Installation (with ozone check valve down): Ozone check valve may stick open or shut causing premature wearing of the check valve (see Figure 5).

NOTE: The injector manifold should be installed above water level whenever possible. If the injector manifold is installed below water level, take proper precautions to prevent water from draining through the injector and damaging the surrounding area. For example, use clamps on all tube connections, run ozone tubing above water level and provide adequate drainage around the pool equipment.

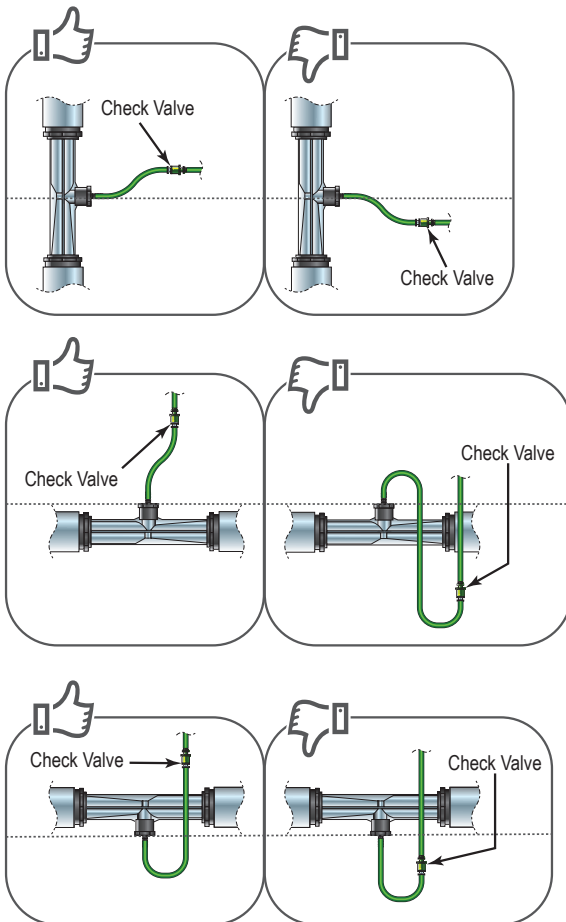

Figure 5. Correct Ozone Check Valve Installation in Alternate Orientation

Installation Steps

1. Locate the appropriate section of the return line.
2. Observe and follow correct water flow direction (indicated by the arrow on the injector manifold).
3. Connect the injector manifold to existing pipe with PVC cement.

Alternate Configurations

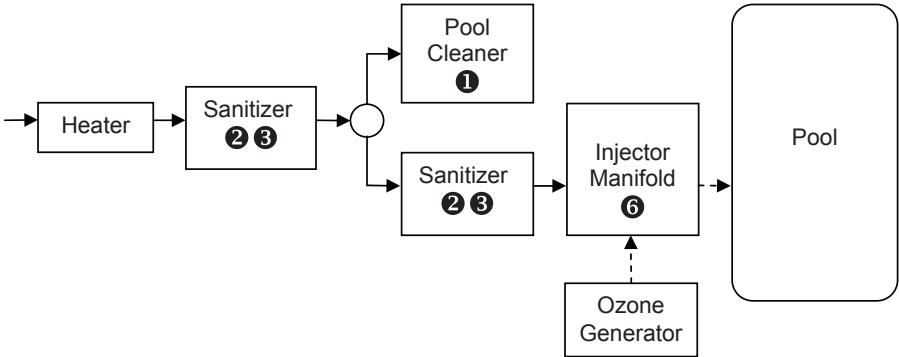

Figure 6. Pool Only Alternate Equipment Configuration

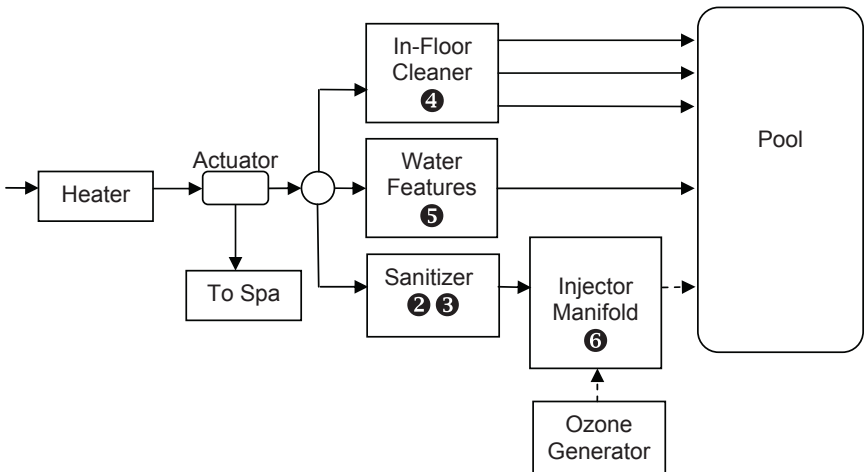

Figure 6. Pool/Spa Alternate Equipment Configuration

- **1 Pool Cleaner:** Always plumb the cleaner T-fitting before the ozone generator to prevent gas from affecting the cleaner operation.
- **2 Salt Chlorinator:** A salt chlorinator should be installed before the ozone generator.
- **3 Chlorine Tab/Mineral Erosion Feeder:** Always plumb the manifold injector after any erosion feeder to avoid gas accumulating in the feeder.
- **4 In-Floor Cleaning System:** The injector manifold must be plumbed on a different pool return leg than any in-floor cleaning system to avoid excess back pressure on the injector. This will also prevent gas intrusion and high oxidizer levels in zone valve and cleaner heads.
- **5 Water Features:** Avoid plumbing the injector manifold into any leg with excessive back pressure such as those going to fountains or restrictive wall fittings, etc.

ALTERNATE STEP: Install a Mixing Degas Vessel (MDV)

As an alternative to the standard injector manifold configuration, a mixing degas vessel (MDV) (Jandy Pro Series PN: CDMDV) may be recommended to reduce the chance of fading at the ozone return fitting in vinyl lined pools.

Refer to the installation instructions included with the MDV.

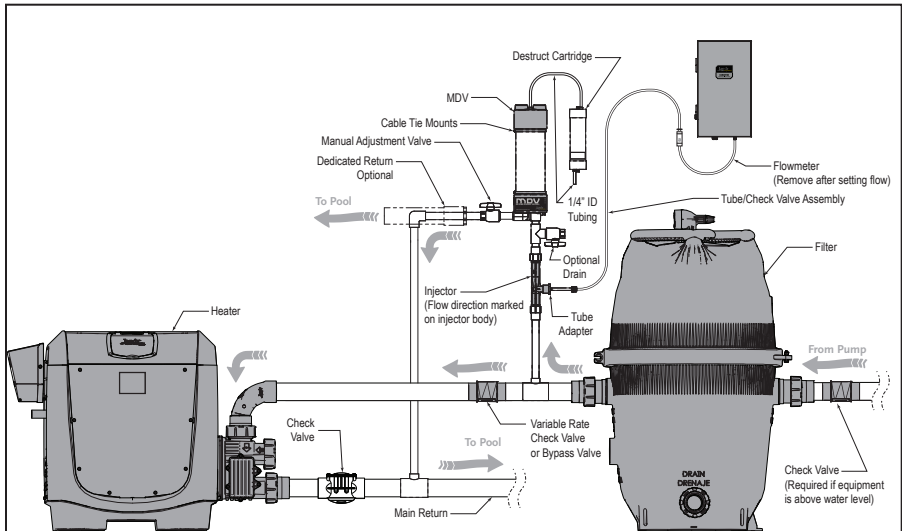

Figure 8. Plumbing Connections with MDV

Step 4. Install a Water Check Valve (if applicable)

If pool equipment is mounted above the water line, a check valve must be installed between the pump outlet and the Injector Manifold to prevent the pump from draining and losing its prime (when not in use).

- Use check valve: PN: R06925.

NOTE: If a check valve is used, do not install immediately after chlorine feeders.

Step 5. Perform a System Pressure Test (if applicable)

IMPORTANT:

If it is necessary to pressure test a new equipment system, perform pressure test before connecting the ozone gas line.

- Install the 3/4" pipe cap provided onto the manifold injector before performing the pressure test.
- Store the pipe cap inside the ozone generator housing for future use.

Step 6. Perform the Ozone Flow Test

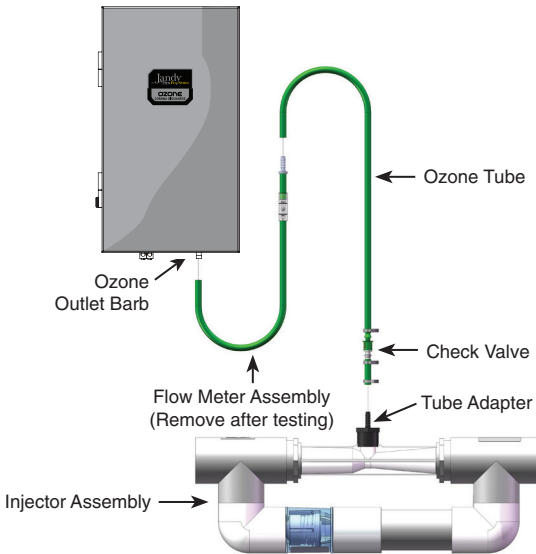

Figure 9. Ozone Flow Test Assembly

1. Install the tube adapter on the manifold injector. Do not use Teflon® thread tape to secure.
2. Connect the shorter piece of ozone tubing (with gas line check valve) onto the tube adapter (Figure 9) and secure with the tube clamp provided.
3. Connect the longer piece of the flow meter assembly to the ozone outlet barb at the bottom of the ozone generator (Figure 9).
4. Connect the remaining ends of the ozone tube and the flow meter assembly (Figure 9).
5. Hold the flow meter assembly tubing so that the clear plastic chamber is vertical with the longer tubing toward the bottom.

6. Turn on electrical power.
7. Turn on the pump.
8. Verify that the metal ball in the flow meter assembly floats between the Max and Min lines (Figure 10).

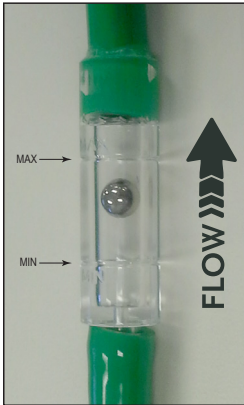

Figure 10. Ideal Ozone Flow Reading

9. If ozone gas flow is too low, verify that other valves in the system are not inhibiting flow through the manifold.

NOTE: The manifold injector comes equipped with a spring-loaded valve to provide a wide operating range and is not adjustable. For additional complications related to ozone gas flow, see Section 6. Troubleshooting.

10. Remove the flow meter assembly from the ozone outlet barb and from the ozone tube. Store the flow meter tubing inside the ozone generator housing for future use.
11. Cut off any excess tubing so that the line from the injector manifold to the ozone generator is straight and free from dips and loops.
12. Connect the end of the ozone tube to the ozone outlet barb. Ensure that all hose barb connections are secured with hose clamps. Secure and route any slack tubing as necessary, to minimize tripping or entanglement hazard.

Section 4. Ozone Generator Operation

4.1 Pool Preparation Before Startup

To achieve optimal performance from the ozone system, the pool or pool/spa combo must be as clean as possible to begin. Perform the following pool preparation steps prior to initial system start-up:

1. Backwash or clean filters one day before starting the ozone generator.
2. Super chlorinate the pool water using a chlorine-based shock treatment prior to ozone system start-up.
3. Test the pool water chemistry and adjust as necessary (see following guidelines, Section 4.2). Repeat testing often and adjust water chemistry as necessary for optimal ozone performance.
4. Run the pool filter continuously for 24 hours prior to initial start-up.

4.2 Water Chemistry

Regular chlorine or bromine testing should be performed as normal. Ozone will be eliminating the majority of contaminants. Therefore, only a small amount of chemicals will need to be added to maintain a minimal residual level of 0.5 - 1.0 ppm chlorine or 1.0 - 2.0 ppm bromine. Ozone is pH neutral thus minimizing pH adjustments.

As a routine, test and adjust water chemistry to within the following guidelines:

- **pH:** 7.4 – 7.6
- **Total Alkalinity:** 80 – 120 ppm
- **Free Chlorine:** 1.0 – 3.0 ppm
- **Combined Chlorine (Chloramines):** None (super chlorinate to remove all chloramines)
- **Chlorine Stabilizer (Cyanuric Acid):** 30 – 50 ppm
- **Calcium Hardness:** 200 – 400 ppm
- **Metals (Iron, Manganese):** None
- **Nitrates:** None
- **Phosphates:** None

4.3 System Startup and Operation

To start the ozone generator:

1. Turn on the pool circulation system.
2. The generator will power up and the green indicator lights on the ozone cells will illuminate.
3. Open the enclosure door by removing two (2) screws on the front panel.
4. Verify that indicator lights for each ozone module are green.
5. Close the door and reinstall two (2) screws on the front panel.

4.4 System Shut-Down and Winterizing

When shutting down for service or winter storage:

1. Disconnect the power to the ozone generator.
2. After the generator has been shut down, the pool water circulation pump may be turned off.
3. (Winterizing) If the system will be shut down for an extended period, disconnect the ozone tubing and tube adapter from the unit and store indoors. Install the 3/4" pipe cap provided on to the injector to seal the system.

Section 5. Scheduled Maintenance

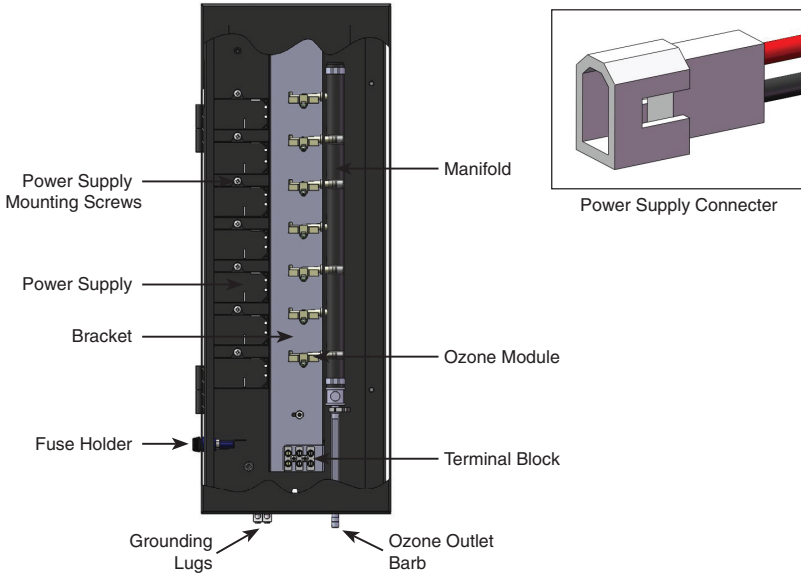

Figure 11. Ozone Generator Electromechanical Components

5.1 Check Power Supply to the Generator

A pale green indicator light on each of the ozone modules (located inside the enclosure) indicates that the power supply is operating properly.

Check inside the unit regularly to verify all the ozone modules are working. If there is direct sunlight, use a shield or your hand to create shade when verifying lights are lit.

When an indicator light goes out, replace the corresponding ozone module.

5.2 Replace Ozone Modules

The CD40, CD70, and CD100 have 3, 5, and 7 ozone modules, respectively. Replace each ozone module whenever an indicator light goes out, or after 15,000 hours of operation, whichever comes first.

If green indicator light(s) are lit but dimly glowing, the ozone module may be producing less ozone due to contamination within the plasma gap ozone chamber. Replace the module even if the green light is still on.

5.3 Verify Ozone Flow

Periodically check the flow meter for proper flow. Always remove the flow meter after confirming proper flow. Always recheck the flow rate if replacing any components in the flow line.

5.4 Replace the Ozone Tube

WARNING

Do NOT touch the ends of the Ozone Tube when replacing. Trace amounts of nitric acid may be present and could prove harmful if touched or ingested.

Replace the ozone tube annually, or as needed. Inspect tube regularly for cracks or wear and replace as necessary.

If there is evidence of water leaking past the gas line check valve (on the generator side), shut off the pump immediately. Replace the ozone tube and the gas line check valve.

If water entered the generator, allow the unit to dry completely before restarting.

NOTE: Evidence of water in the ozone generator may void the warranty.

Section 6. Troubleshooting

WARNING

RISK OF ELECTRIC SHOCK Always turn off power to the unit prior to attempting service or repair. Knowledge of electrical applications is required for troubleshooting. Contact a certified electrician if you are unsure of your ability to service the equipment. Improper servicing will void generator warranty and could result in injury or death. If any condition persists, contact Zodiac technical support at 1-800-822-7933.

PROBLEM	REASON	SOLUTION
<i>Module indicator lights not lit when pool system is on</i>	No power to the ozone generator from the power source	<ul style="list-style-type: none"> • Check circuit breaker at the power distribution box. • Check for loose connections or wiring breaks from the power distribution box to the generator.
	The fuse in the unit has blown	<ul style="list-style-type: none"> • Replace fuse with a glass, .25" x 1.25", 1 amp, slo-blo type
	G.F.C.I. has tripped.	<ul style="list-style-type: none"> • Check power cord and reset G.F.C.I.
<i>Flow meter not indicating flow</i>	Injector not supplying adequate suction	<ul style="list-style-type: none"> • Check pump, filters, and skimmers to ensure water is flowing through injector. • Ensure that there is no debris clogged inside the injector.
	Tubing is impaired	<ul style="list-style-type: none"> • Check for kinks or clogs. • Check for cracks or cuts. • Check connections. • Check that the gas line check valve is installed with the arrow pointing towards the injector. • Be sure that the gas line check valve has not become fouled with debris. Disconnect the Ozone Tube from the injector. With the pump running, cover the end of the injector with your thumb, and feel for suction. If there is sufficient suction without the gas line check valve, replace the gas line check valve with a new one.
<i>Ozone Tube becomes yellow/ brown and brittle</i>	It is normal for high concentration of ozone, as well as exposure to UV sunlight to deteriorate the ozone tube	<ul style="list-style-type: none"> • Replace the ozone tube and gas line check valve every year. • In between annual maintenance, check for cracks or leaks and replace as necessary.
<i>Ball for flow reading is not in center of flow meter</i>	Flow meter provides a general guideline only and flow will vary with differing pressures through the injector or affected by filter, strainer loading, etc.	<ul style="list-style-type: none"> • If ball is moving, ozone generator can perform well at flows above and below recommended range. • Check the strainer for clogging. • Check the filter.

Section 7. Technical Support

For technical assistance

Call: 800.822.7933
Email: productsupport@zodiac.com
Or visit our website: www.ZodiacPoolSystems.com

Section 8. Replacement Parts

DESCRIPTION	PART NUMBER
Ozone Module Replacement Kit	R0693200
Tubing Replacement Kit	R0693800
Replacement Fuse, 1A Slo-Blo	R0693300
Variable Rate Check Valve	R0692500

NOTE: The warranty is void if the parts listed above are not replaced at recommended intervals according to the Scheduled Maintenance guidelines in this manual.

Zodiac Pool Systems, Inc.
2620 Commerce Way, Vista, CA 92081
1.800.822.7933 | www.ZodiacPoolSystems.com

ZODIAC® is a registered trademark of Zodiac International, S.A.S.U., used under license. All other trademarks referenced herein are the property of their respective owners.

©2015 Zodiac Pool Systems, Inc. H0514200 REVD