

Wood Deck Anchor

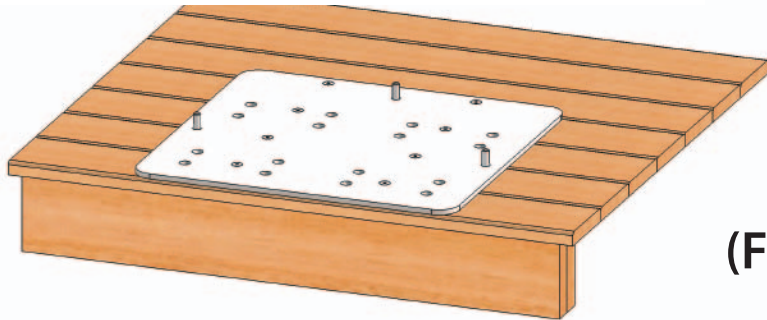

**PART #: F-107UEWDA
(For Spa Lift Ultra & Elite)**

MANDATORY – LEAVE THIS MANUAL WITH LIFT OWNER



Read & follow all instructions
Lift safety can only be ensured if the anchor is installed and operated according to these instructions



NEVER permit children to play on or around the lift
Do not allow children to use the lift without adult supervision



NEVER apply direct water pressure to the electronics

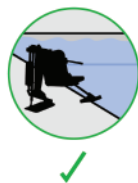

NEVER use the lift with a dry pool



For safety reasons, **NEVER** swim alone

9889 Garrymore Ln
Missoula, MT 59808
888-687-3552 | +1-406-549-0769
aquacreek.com



SAVE a copy of these instructions

Parts List

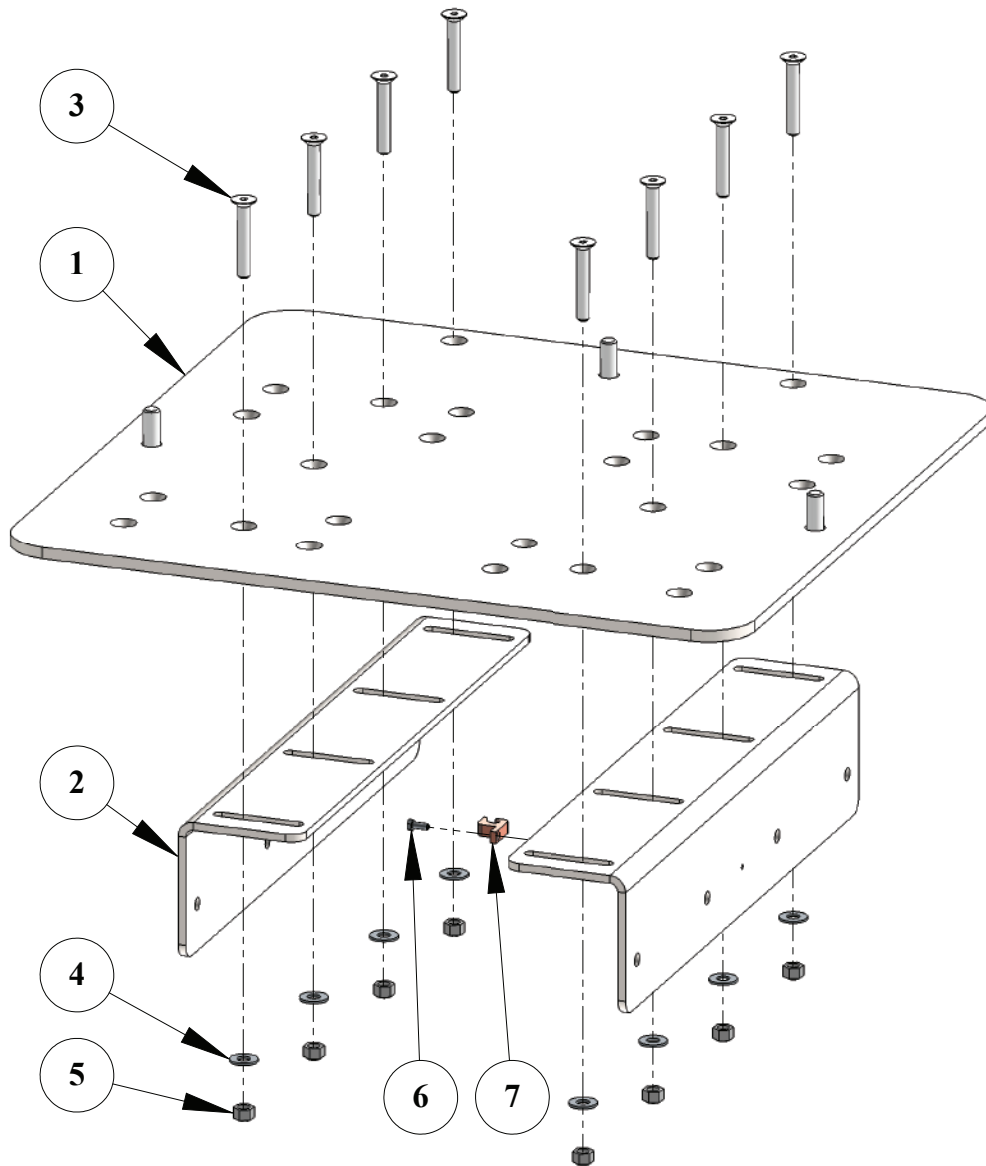

| ITEM # | QTY | PART # | DESCRIPTION |
|--------|-----|-------------------------|------------------------------------|
| 1 | 1 | SLE-WDP-00 | WOOD DECK ANCHOR PLATE, ELITE |
| 2 | 2 | PS6-WDB-00 | WOOD DECK BRACKET, PRO SPA |
| 3 | 8 | BC 3/8 X 2-1/2 | BOLT, 316 SS, 3/8-16 X 2 1/2 FHSCS |
| 4 | 8 | WF 3/8 | WASHER, FLAT, 3/8, 316 SS |
| 5 | 8 | NN 3/8 | NUT, 316 SS, NYLOCK, 3/8"-16 |
| 6 | 1 | BSH 10 X 1/2 | BOLT, 316 SS, 10-24 X 1/2", SHCS |
| 7 | 1 | GBL-4DB | LUG, IN GROUND GROUNDING LUG |
| 8 | 1 | ANTI SIEZE, PACKET, .75 | ANTI SIEZE, PACKET, 5 GRAMS |

NOTE: No hardware is supplied to mount the two (2) wood deck brackets to the joists as the type and length of bolt may vary depending on application. Based on the accessibility to the deck joists, you will need to source the proper length 3/8" stainless steel hex bolts, 3/8" flat washers and 3/8" nylock nuts to attach through the deck joist(s). Or, 3/8" lag bolts to attach directly into the deck joist(s). Aqua Creek recommends type 316 Stainless on all individually sourced hardware if available.

Installation Options: Joist Direction & Setback

The wood deck anchor has been designed so it can be mounted on a wood deck with joists running either side-to-side (east to west) or front-to-back (north to south). The following diagram shows these two different configurations to help determine proper installation.

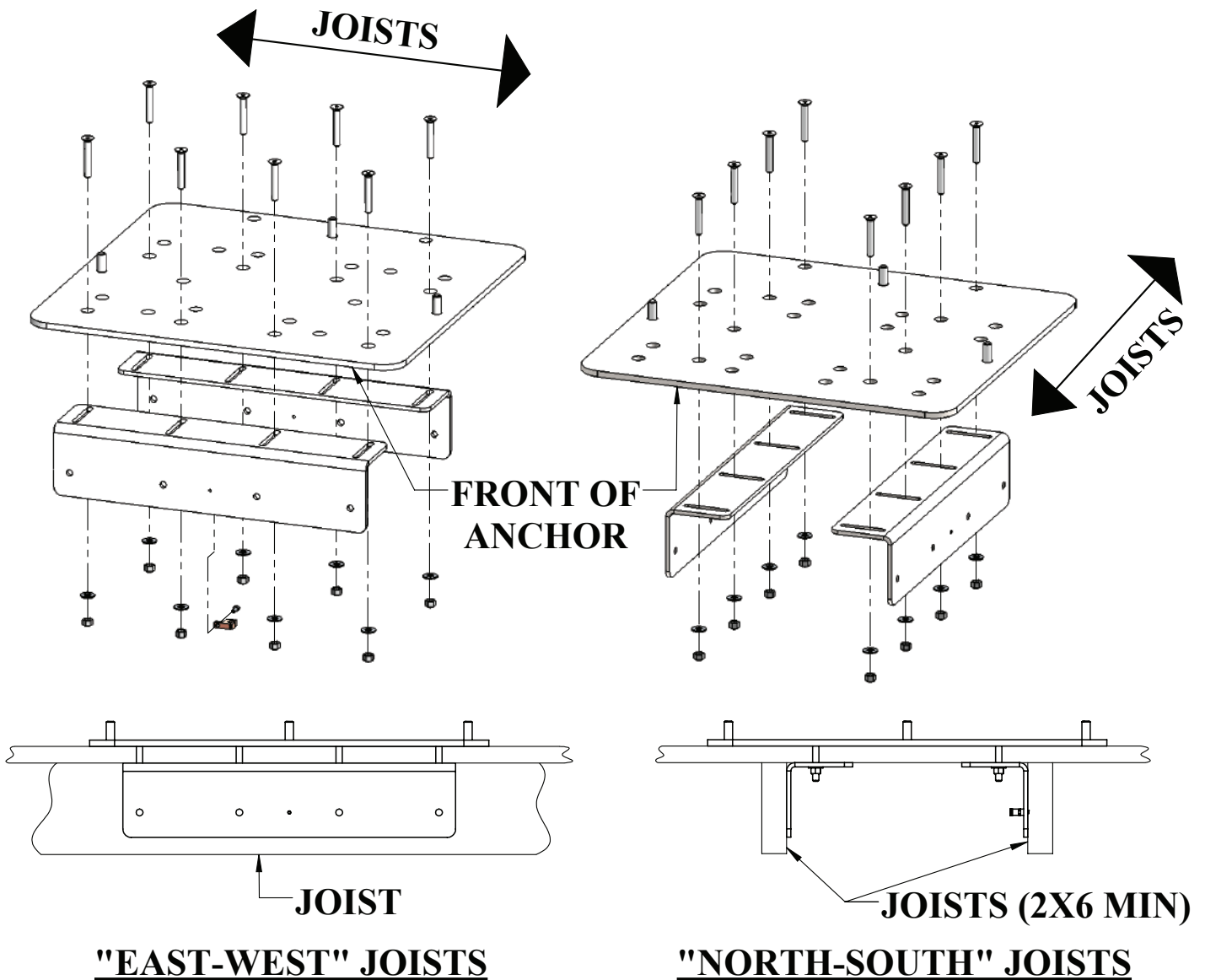

NOTE: Front of anchor faces the spa/pool wall.

Anchor Installation

The front lift mounting studs in the anchor plate are 10" from the front of the anchor plate. The front mounting studs need to be 10" from the spa/pool wall so the edge of the plate should be flush with the edge of the deck or overhanging the deck slightly if the deck does not touch the outside edge of the spa/pool wall.

1. Place the anchor plate in position parallel with the spa or pool wall and/or edge of the deck, and equally spaced over the joists. (See drawing for appropriate application)
2. Mark and drill the eight (8) holes through the deck surface with a 3/8" drill bit for the plate mounting bolts.
3. Insert the plate mounting bolts through the plate and deck surface to help properly position and secure the wood deck brackets to the joists under the deck. (The slotted holes in the wood deck brackets will allow for minor adjustments if needed).
4. With the plate mounting bolts lined up with the slots in the wood deck brackets mark and drill through the joists or otherwise secure the brackets to the joists using the 3/8" hardware sourced locally.
5. Finish by securing the anchor plate with the supplied 3/8" x 2 1/2" stainless steel flat head screws, washers and nylock nuts.

NOTE: Apply Anti-Sieze to all stainless steel hardware to prevent the hardware from galling which will essentially weld the hardware together making it difficult if not impossible to remove.

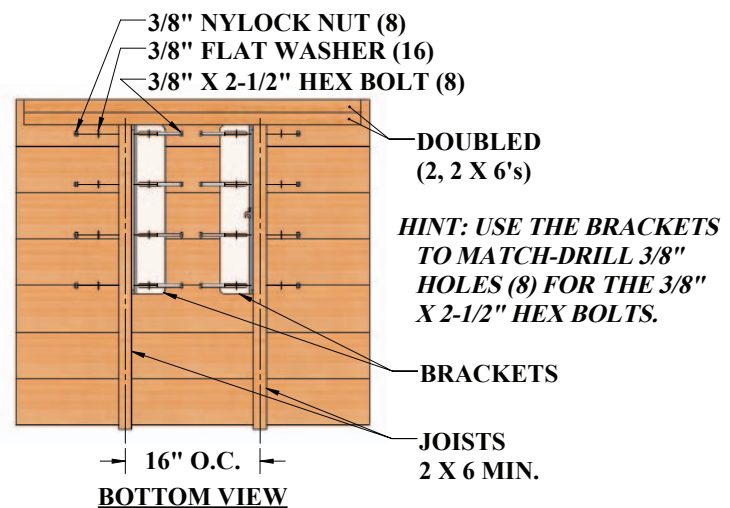
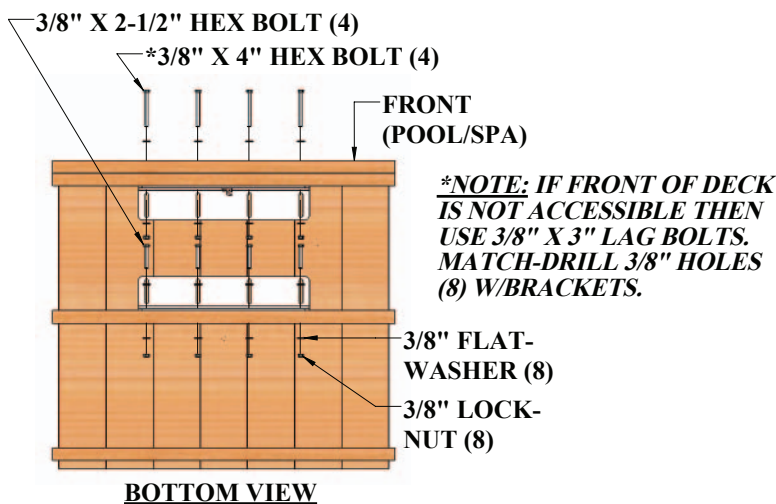
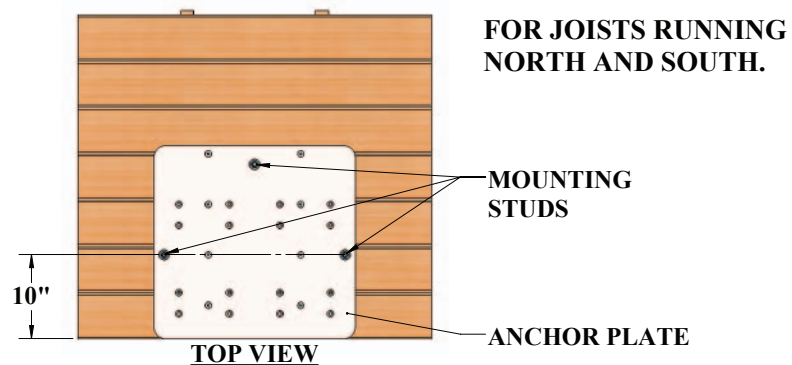
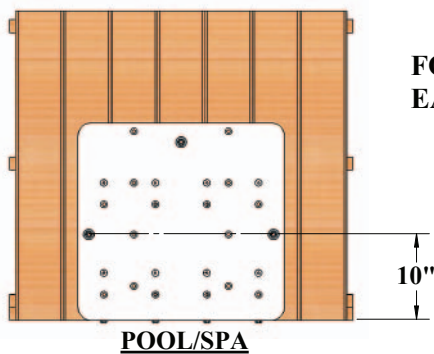

Lift Installation

The Elite or Ultra Spa Lift is shipped via truck and will arrive mostly assembled and ready to install onto the anchor.

1. Carefully unpack the lift and inspect for any damages or missing components.
2. With another person, lift the main lift assembly off the crate and place over the top of the wood deck plate aligning the three mounting studs with the mounting holes in the triangular base of the lift.
3. Secure the lift to the plate with the three (3) stainless steel washers and nylock nuts. Use anti-sieze on the hardware to keep the hardware from galling.
4. Follow assembly instructions in the lifts owner's manual.
5. Run the lift up and down and side-to-side to make sure it is running smoothly. Make sure the lift doesn't wobble as it rotates. Then the lift is ready for use.

