

# INSTALLATION MANUAL



*The High Efficiency  
Ultra-Quiet Heat Pump Series  
from GulfStream*





*The High Efficiency  
Ultra-Quiet Heat Pump Series  
from GulfStream*

## INTRODUCTION

This manual was designed to inform you on the correct way to install the **Gulfstream Heat Pumps**. By following these simple instructions, you will be able to eliminate unnecessary time wasted on job sites.

This is not step-by-step installation manual, but a reference guide if you have questions.

We have also added **ATTENTION**, **WARNING**, and **CAUTION** boxes to help you identify the most important things to watch out for.

**Please make sure the warranty card and Homeowner Manual are given to the Homeowner after each installation. These are located inside the heat pump, in the same package with the unions.**

### ATTENTION, WARNING, and CAUTION

Boxes have been placed throughout manual to point out important information.

**Attention:** Important information to be aware of.

**Warning:** Action that might void warranty.

**Caution:** Safety issue for owners.



For questions about installation please call the  
Heat Pump Services Department from the job site.  
**954-318-6900**



Electrical requirements can be found on the  
rating plate located  
on the bottom front of the base pan of the unit.



It is the responsibility of installers to make sure  
all applicable codes related to  
the installation of this product are followed.





*The High Efficiency  
Ultra-Quiet Heat Pump Series  
from GulfStream*

---

## **TABLE OF CONTENTS**

---

	<b>PAGE</b>
<b>Introduction</b>	<b>1</b>
<b>Location of Heat Pump</b>	<b>3</b>
Preferred Location Placement	
Example of Normal Installs	
Cold Air Recirculation	
<b>Do's and Don'ts of Plumbing the Unit</b>	<b>4</b>
<b>Plumbing Sequence</b>	<b>5</b>
<b>Multiple Heater Install</b>	<b>6</b>
<b>Electrical</b>	<b>7</b>
<b>Low Voltage Wiring</b>	<b>8</b>
Location of Voltage Wires	
<b>Bonding the Unit</b>	<b>9</b>
<b>Board Operation</b>	<b>10</b>
Board Features to Explain to Home Owner	
Lock-Out - Lock Access to Board	
<b>Hidden Service Menu/Set Preferences</b>	<b>11, 12</b>
Select Language	
Remote T-Stat	
Solar Control	
Time Delay	
Spa Timer	
<b>Even-Heat Feature for Pool   Spa</b>	<b>13</b>
<b>Heat - Cool Unit Operation</b>	<b>14</b>
<b>Diagrams</b>	
Plumbing Sequence Diagram	<b>5</b>
Multiple Heater Wiring Diagram	<b>15</b>
Pool Wire Diagram	<b>16</b>
Even-Heat Control Diagram	<b>17</b>
<b>Contact Information</b>	<b>18</b>

## LOCATION OF HEAT PUMP

Location is probably the most important consideration when installing a heat pump. Poor installation can adversely affect performance, as well as cause problems with servicing and overall customer satisfaction.



### PREFERRED LOCATION PLACEMENT

Have as much space as possible between the heater and house or any overhangs. Example shown is a preferred installation but is not always practical.

### EXAMPLE OF A NORMAL INSTALL

See an example of a standard installation, which should work correctly with the space available.



Make sure there are no overhangs that would cause the unit to recirculate the cold air. This will make the unit go into defrost mode.



### COLD AIR RECIRCULATION

The heat pump gets its heat from the surrounding air; therefore, recirculation of the cold air off the top of the unit should be avoided. Enclosed spaces such as garages and sheds without proper ventilation should be avoided and may void warranty of the refrigerant components. In order to maintain maximum performance, avoid low overhangs such as porches, overhanging brush, etc., whenever possible.



## DOs & DON'Ts OF PLUMBING THE UNIT

Consider the direction the heater is facing. The water connections run out the side of the heater. This keeps piping out of the way so customers and service personnel don't step on or trip over the piping. It defeats the purpose to run the piping back around the front of the heater. Try to keep all piping out of the way.

# Do!

Do plumb unit to side.



# Don't!

Don't run pipes back around to the front of the unit. This makes access to the panel difficult for service.



# Don't!

Don't plumb unit so that service personnel cannot remove or easily access the corner panel.

### ATTENTION



A simple 90° turn can make all the difference for easy access between serviceable and non-serviceable.

### ATTENTION



*Good Example*

THE CONTROL PANEL MUST ALWAYS FACE OUT, away from walls and obstructions for ease of customer use and serviceability.



*Bad Example*



## PLUMBING SEQUENCE



It is very important to plumb in the correct order.



## PLUMBING SEQUENCE

***The piping sequence is Pool Pump – Filter – Heater – Chlorination System(s) – Pool.***

Rigid PVC piping is recommended and all joints secured with PVC glue. Installation **MUST** conform to all local codes. Make sure water-flow is correct as indicated on the back of the heater. Again, try to keep piping away from areas that may be tripped over or stepped on when operating heater or servicing. Try to keep elbows and piping to a minimum to avoid excessive pressure drop. We use a full-flow heat exchanger so no external bypass is needed up to 90 GPM (*Gallons Per Minute*).

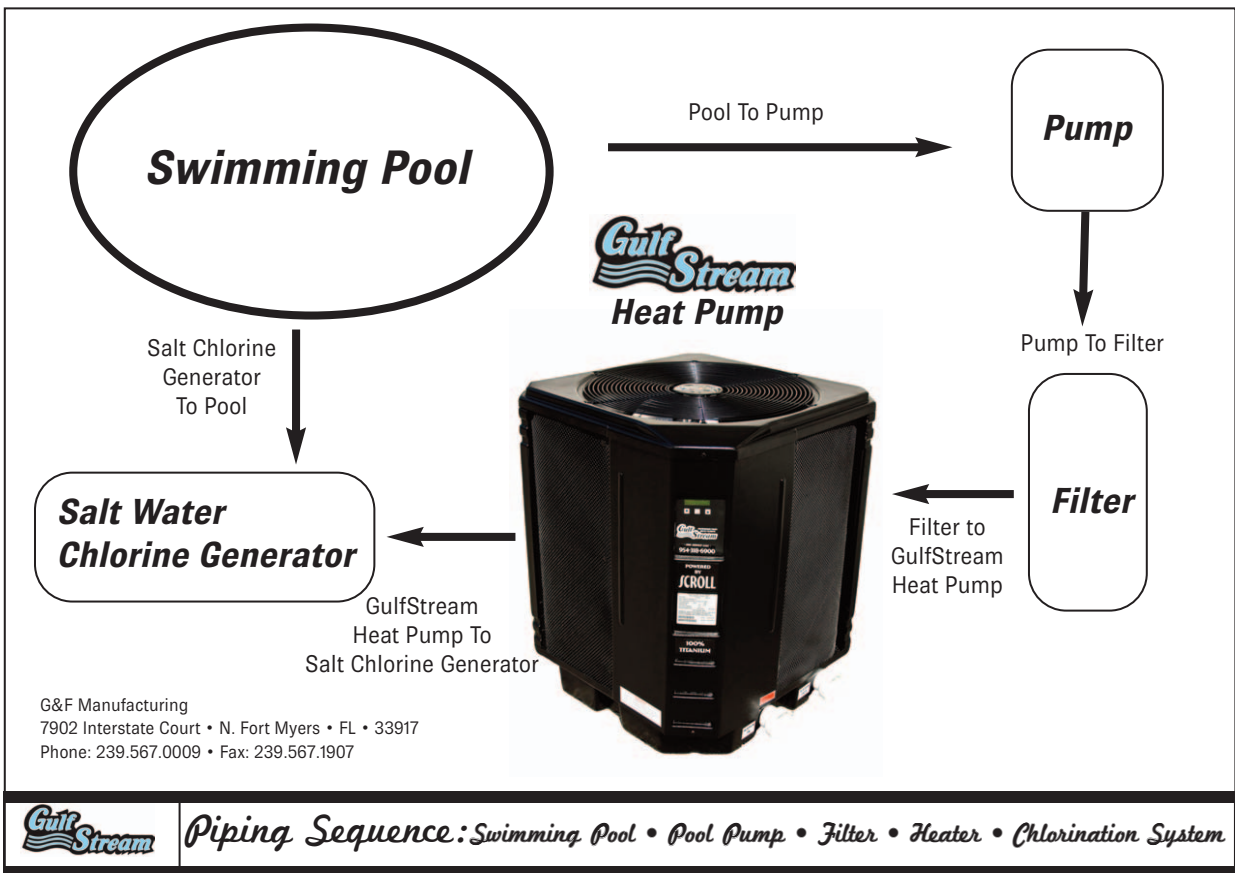

Please call the **Heat Pump Services Department** if you have questions about the plumbing order.

**954-318-6900**



## MULTIPLE HEATER INSTALL

Multiple heater plumbing must be designed with balancing valves and flow meters to assure at least minimum water-flow to each heater. You will want to consult with our service department for important technical data prior to installation.

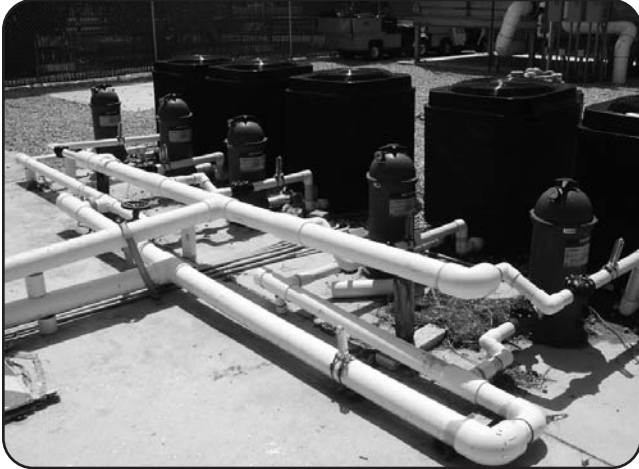

**ATTENTION**

A diagram of the system's flow should be drawn out prior to installation. This will prevent plumbing errors while on site, and help ensure the installation will go quickly.

**ATTENTION**

### WIRING MULTIPLE HEATERS TO BE CONTROLLED BY ONE MASTER HEATER

1. Install external 2-pole 24-volt contactor.
2. Wire master contactor low voltage tabs to external contactor low voltage tabs.
3. Run low voltage wire from **Heater 2'** s pools/spa terminal on back of board to external contactor, L1 and T1.
4. Run low voltage wire from **Heater 3'**s pools/spa terminal on back of board to external contactor, L2 and T2.

*Pay close attention to different wiring colors to avoid confusing the wires during this set-up. In addition to causing installation delays and aggravation, mismatched or incorrect wiring may also cause problems with heater operation.*

5. Program Remote T-Stat setting to ENABLED on **Heater 2** and **Heater 3**.
6. This system is designed so that when master **The Master Heater** turns on, it energizes the contactor, causing all sub units to run until **The Master Heater** shuts off.

*You may also want to program the time delay on **Heater 2** to 6 minutes, and **Heater 3** to 7 minutes. This prevents the units from kicking on all at once, which may cause a power surge.*

*Connecting another external contactor to low voltage tabs of the external contactor, you may wire an additional heater and all will be controlled by **The Master Heater**.*

**MULTIPLE HEATER WIRING DIAGRAM LOCATED ON PAGE 16**



# ELECTRICAL

A qualified electrician must install the electrical power in accordance with local code requirements. Conduit must be run all the way up to electrical box and installed with appropriate connector. Failure to do so voids warranty of electrical components. Running wires as seen in Picture 1 not only allows snakes, bugs, lizards, etc., into box, which could possibly short components, but also poses a direct short hazard where wires penetrate the control box.



Picture 1 - Bad Example

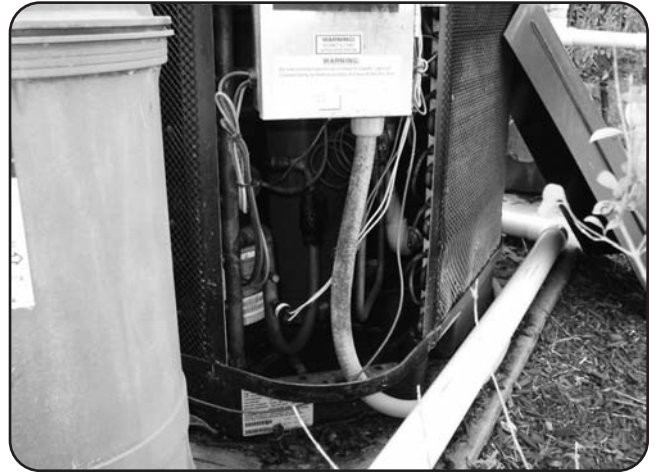

Picture 2 - Good Example



Bugs or lizards getting into board or shorting out the board will not be covered by warranty.



In the bottom of the control box, there is a rubber-piercing plug through which to run low-voltage wiring for external controllers. Simply use a sharp tool, such as a razor, to pierce the plug and run the external control wires through it.



Step One



Step Two





## LOCATION OF LOW VOLTAGE WIRES

On the top right-hand corner of the control board, are the connections for outside controllers. Only Dry Contact (no voltage) Connections are to be made here. You may connect external controllers with a thermostat, without a thermostat, flow-switches, etc., to these connections.

### CAUTION

Not using the designated area to run your wires can cause safety issues and void warranty.

**ATTENTION**

To connect a three-wire controller, use common and either High or Spa, depending on switch, to these connections and disregard Pool or Low wires.

**ATTENTION**



**ATTENTION**

Wiring diagrams can be found on the back pages of this manual.

**ATTENTION**



## BONDING THE UNIT

Bonding is often confused with electrical grounding. On the outside of our control box, on the bottom right-hand corner, is a bonding lug. Because all metals have different electrical potentials, all metal and electrical components of the pool system MUST be bonded together.

**ATTENTION**

Check all local and state code requirements.

**ATTENTION**



### *Bonding The Unit Diagram*

G&F Manufacturing

7902 Interstate Court • N. Fort Myers • FL • 33917

Phone: 239.567.0009 • Fax: 239.567.1907

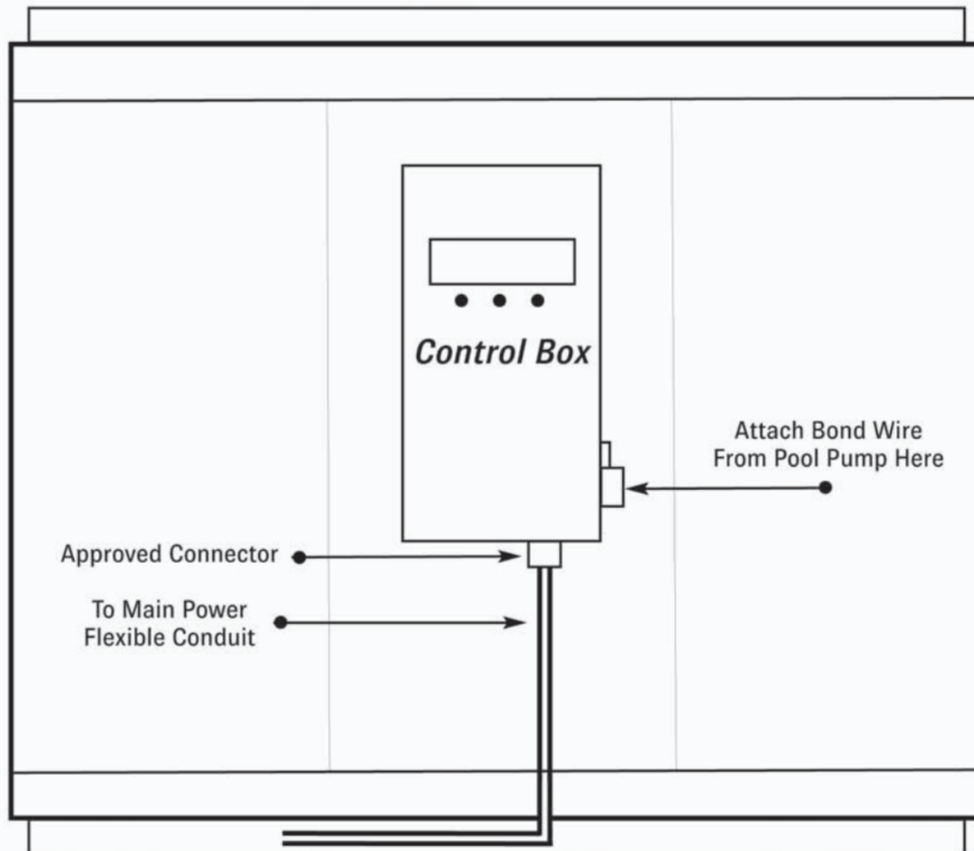

**WARNING**



Damage caused by incorrect or no bonding will not be covered by warranty.

**WARNING**



# BOARD OPERATION

Board operation is kept simple. You simply need to use the **Mode** button to toggle between Pool and Spa and **Up and Down Arrows** to adjust temperature set points.

**WARNING** Do not leave these instructions where the Homeowner can see. If the Homeowner tampers with and/or damages the programming on the board, the warranty will be voided. **WARNING**

## BOARD FEATURES TO EXPLAIN TO THE HOMEOWNER



**ADJUSTING TEMPERATURE:** Use the **Mode** button to toggle between pool and spa. Use **Up and Down Arrows** to adjust temperature set points.



**LOCKING AND UNLOCKING THE CONTROLS:** You may also lock settings by simply pressing and holding the **Mode** button for approximately 20 seconds until "Locked" displays on the digital readout. Repeat same to unlock controls. These are the only controls the customer needs to know about or use. All other set-ups are done in the hidden menu and should not be relayed to customer.

**ATTENTION** Do not leave these instructions where the Homeowner can see. If the Homeowner tampers with and/or damages the programming on the board, the warranty will be voided. **ATTENTION**



## HIDDEN SERVICE MENU

### ALL OPTIONS AND CALIBRATIONS ARE IN THE "HIDDEN MENU".

Only the Hidden Menu items on the previous page, related to Temperature and Lock/Unlock should be shared with the Homeowner. Any of the **other following** options in the hidden menu are for service technicians ONLY!!!



Any *Programming Damage* caused by non-service technician will not be covered by warranty, and will result in a voided warranty.

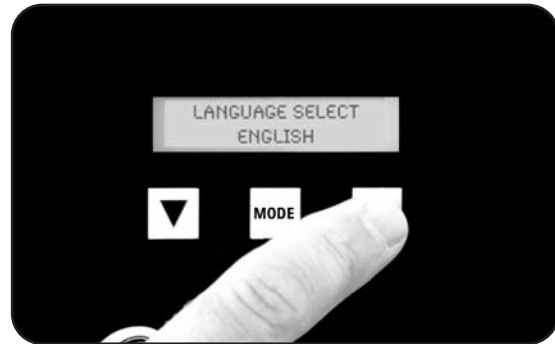
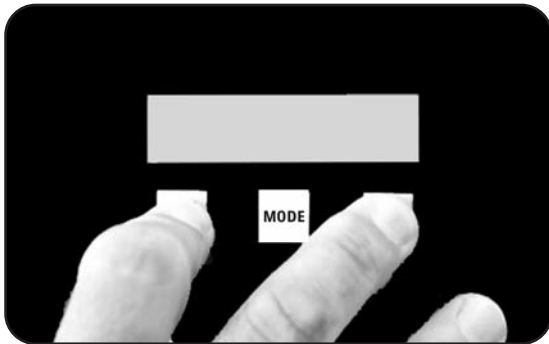

### TO ACCESS THE "HIDDEN MENU" OPTIONS

Press and hold **Up and Down Arrows** at the same time until Option 1 appears in the display. Release arrow buttons, and use **Mode** to toggle through options. Use **Up and Down Arrows** to change settings at each option.

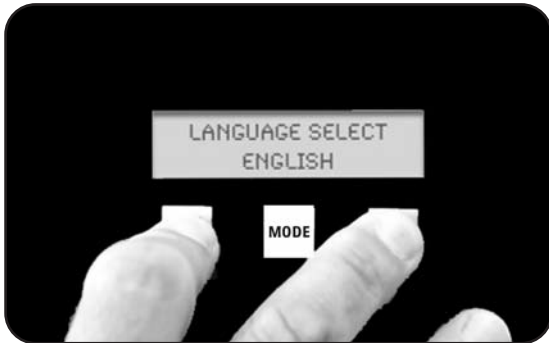

### OPTION 1: Language Select (Default is "English")

Options: English, Spanish, French, Portuguese & German.  
Press the **Up OR Down Arrows** to toggle between selections.

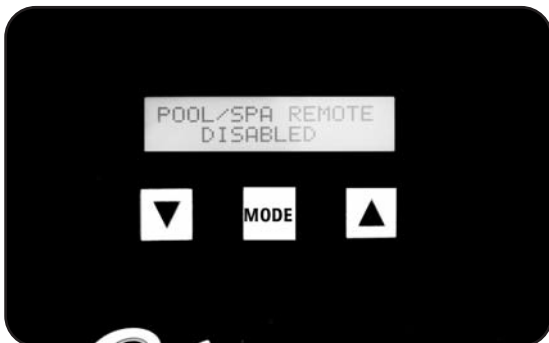

### OPTION 2: Remote T-Stat (Default is "Disabled")

This option is used for an external controller with its own thermostat, such as an *Aqualink*, *Aqualogic*, *Compool*, etc.  
Press the **Up OR Down Arrows** to display "Enabled" if using an external thermostatic controller.



# HIDDEN SERVICE MENU

*Continued*

**OPTIONS 3 & 4: HEAT/COOL SEE PAGE 15.**

Options in the hidden menu are for service technicians ONLY!!!

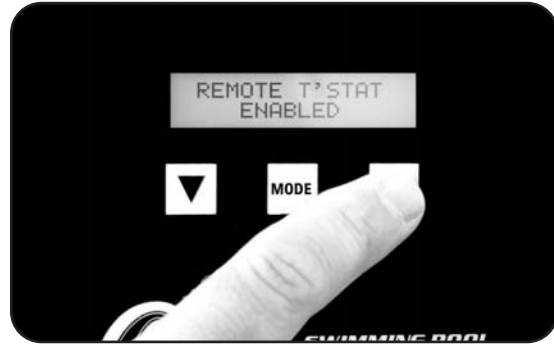

## OPTION 5: Solar Control (Default is "Disabled")

This option, with additional wiring, will allow the GulfStream Heat Pump to monitor the performance of the pool's solar heating system, and will automatically control the temperature.



## OPTION 6: Time Delay (Default is "5 Minutes")

You may temporarily set the delay to "0" by pushing the **Down Arrow**. The system will automatically revert back to 5-minute time delay after 10 minutes.

**ATTENTION**

"OFF" will not allow the spa to run.

**ATTENTION**



## OPTION 7: Spa Timer (Default is "Continuous")

This option is for rental properties or Homeowners who do not want the spa to be left on indefinitely. Options are: *Continuous, Off, or Up to 20 hours in 15-Minute Increments.*



## HIDDEN SERVICE MENU

*Continued*

**OPTIONS 8: EVEN HEAT OPERATION | SEE BELOW - BOTTOM OF PAGE**

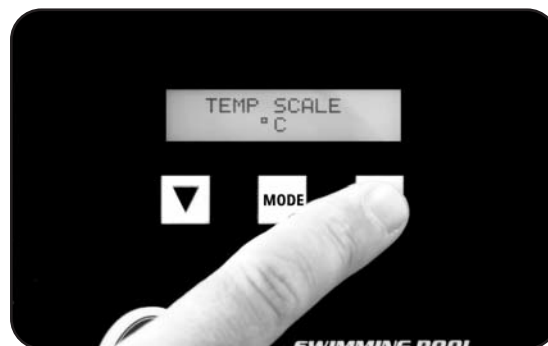
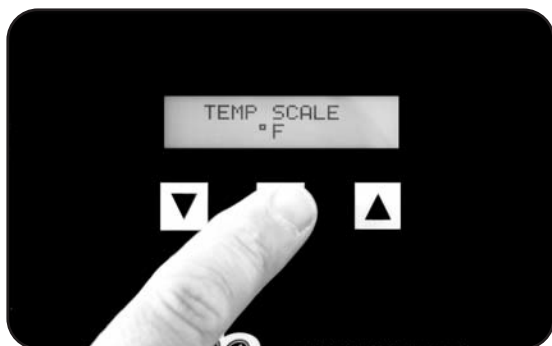

### OPTION 9: Temperature Scale (Default is "Fahrenheit")

Use **Up and Down Arrows** to set *Fahrenheit* or *Celsius* to show on display screen.

## EVEN-HEAT FEATURE ON POOL/SPA

### OPTION 8: Even-Heat (Default is "Disabled")

When enabled, this feature is activated when Water Pressure Switch, (WPS) is sensed open for more than 1 minute. The WPS being open for more than 1 minute serves as an indication to the control board that the external timer has timed out and pump has been shut off. This feature is meant to periodically turn the pump on based on the *Even-Heat Delay* setting and circulate the water. Time interval options are: *1 Hour, 2 Hour, 3 Hour, 4 Hour, Default, and Off*. The water circulation distributes the heat evenly and control will sample water temperature to find out if there is a need for heating. If there is a need for heating, the heat pump will heat until temperature set point is reached. The pump will then be de-energized and the *Even-Heat* timer will reset. If there is no call for heat when the pump is turned on, the pump will shut off after a 5-minute time delay and the *Even-Heat* timer will reset.

During *Even-Heat* time delay if WPS is sensed closed then *Even-Heat* Feature is canceled. The *Even-Heat Delay* setting remains per user setting in the set up menu. *Even-Heat* is activated when WPS is sensed open again for more than 1 minute.

In case the water flow switch does not close on the second attempt, control will then display "*EVEN-HEAT, LOCKOUT*" and stop outputting. The user will have to reset power to the heat pump to unlock the control. Protection features with regard to the state of WPS, LPS and HPS apply when compressor is running.

### INSTALLING AN EVEN- HEAT FEATURE

To install an *Even Heat Feature*, wire an extra contactor in parallel with time clock (See *Wiring Diagram, Pg. 18*). Wire low voltage side of contactor to control board marked "Pump" (See *Wiring Diagram, Pg. 18*). Set desired *Time Interval* that you would like the heater to check the water temperature.

**WARNING**



Incorporating the *Even-Heat Feature* will change the efficiencies of your Heat Pump operation.

**WARNING**



**ATTENTION**



See the *Even-Heat Feature* wiring diagram on *Page 18* of this manual.

**ATTENTION**



# HEAT | COOL UNIT OPERATION

**OPERATION INSTRUCTONS FOR HEAT | COOL MODELS ONLY. COOLING FEATURE IS ONLY FOR POOL, NOT FOR SPA.**  
There are 2 Choices of Heat | Cool Options

## *Choice One*

### HEAT | COOL

#### OPTION 3 IN "HIDDEN MENU"

*This will allow your Heat Pump to keep the temperature in your pool at the same temperature, so if your unit gets 2° warmer or colder, the unit will heat or cool the pool until it reaches set point again.*

1. Go into service menu by pressing and holding the **Up or Down Arrows** at the same time, until screen changes to Language Select - Default is "English."
2. Press the **Mode** button until screen says -Default is: "Pool - Heat/Cool."
3. Screen will read "Pool-Heat/Cool Disabled" - Press **Down Arrow** to enable it.
4. Wait approximately 20 seconds for screen to display "Back to Pool-Heat."
5. Press **Mode** button; screen will switch to "Pool - Heat/Cool."
6. Use **Up or Down Arrows** to adjust pool temperature set point to desired temperature.
7. Press **Mode** button while still in the Pool Temp set point screen.

## *Choice Two*

### HEAT *or* COOL

#### OPTION 4 IN "HIDDEN MENU"

*This will allow your HP to either Heat or Cool your pool*

1. Go into service menu by pressing and holding the **Up or Down Arrows** at the same time, until the screen changes to Language Select - "English."
2. Press the **Mode** button until screen says -Default is: "Pool - Heat/Cool."
3. Screen will read "Pool-Heat/Cool Disabled" - Press **Up Arrow** to enable it.
4. Wait for screen to go back to "Pool-Heat." (After 20 seconds).
5. Press **Mode** button; screen will switch to "Pool - Heat/Cool."
6. Set temperature and let it go through the delay. The unit will start cooling the pool until it hits the set point.
7. To switch back to Heat, press the **Mode** button till it displays "Pool-Heat."



# DIAGRAMS

Wiring diagrams referenced throughout this manual appear on the following pages.  
**Multiple Heater Wiring Diagram | Pool Heater Wiring Diagram | Even-Heat Control Diagram**

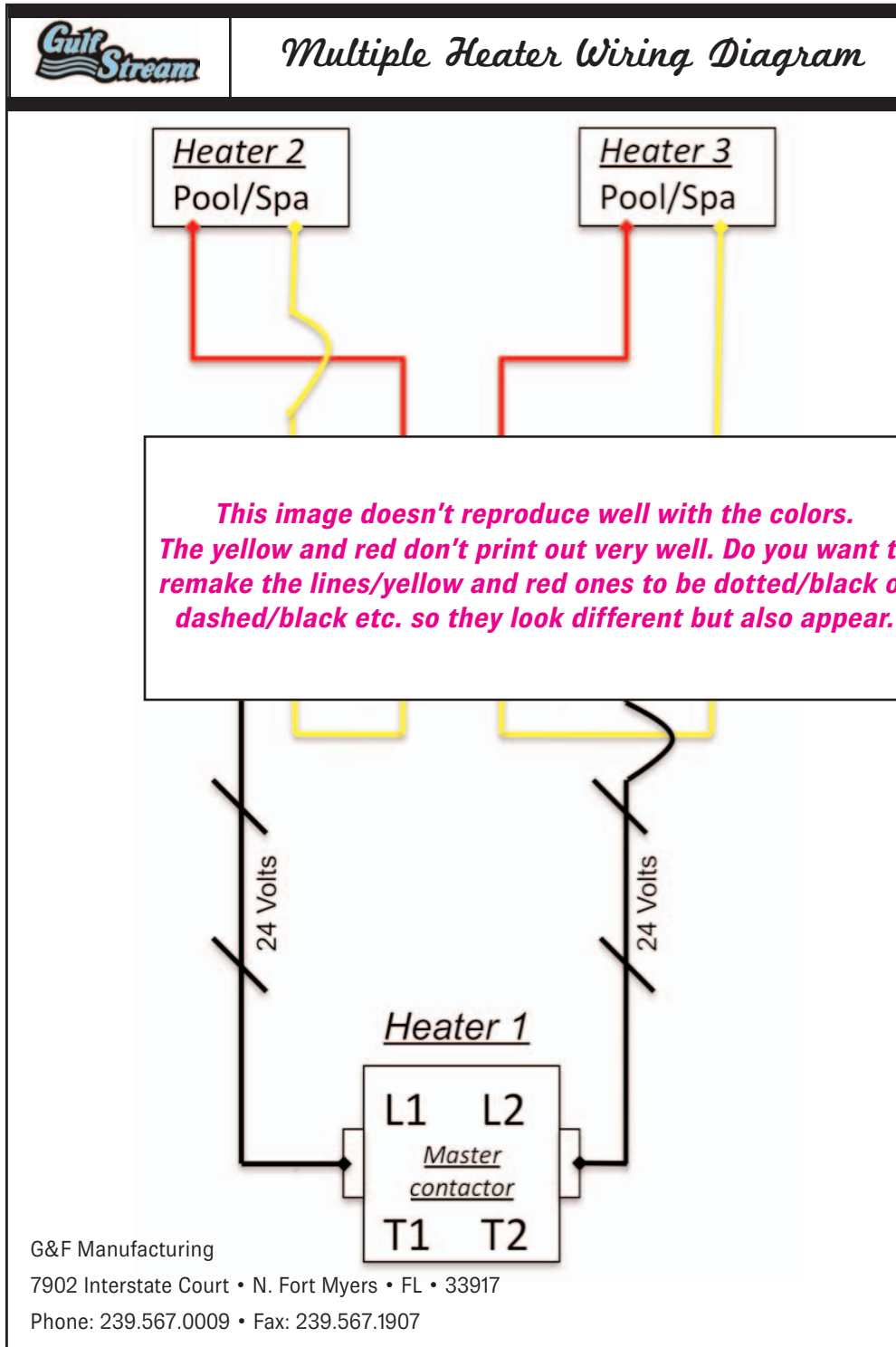



# DIAGRAMS

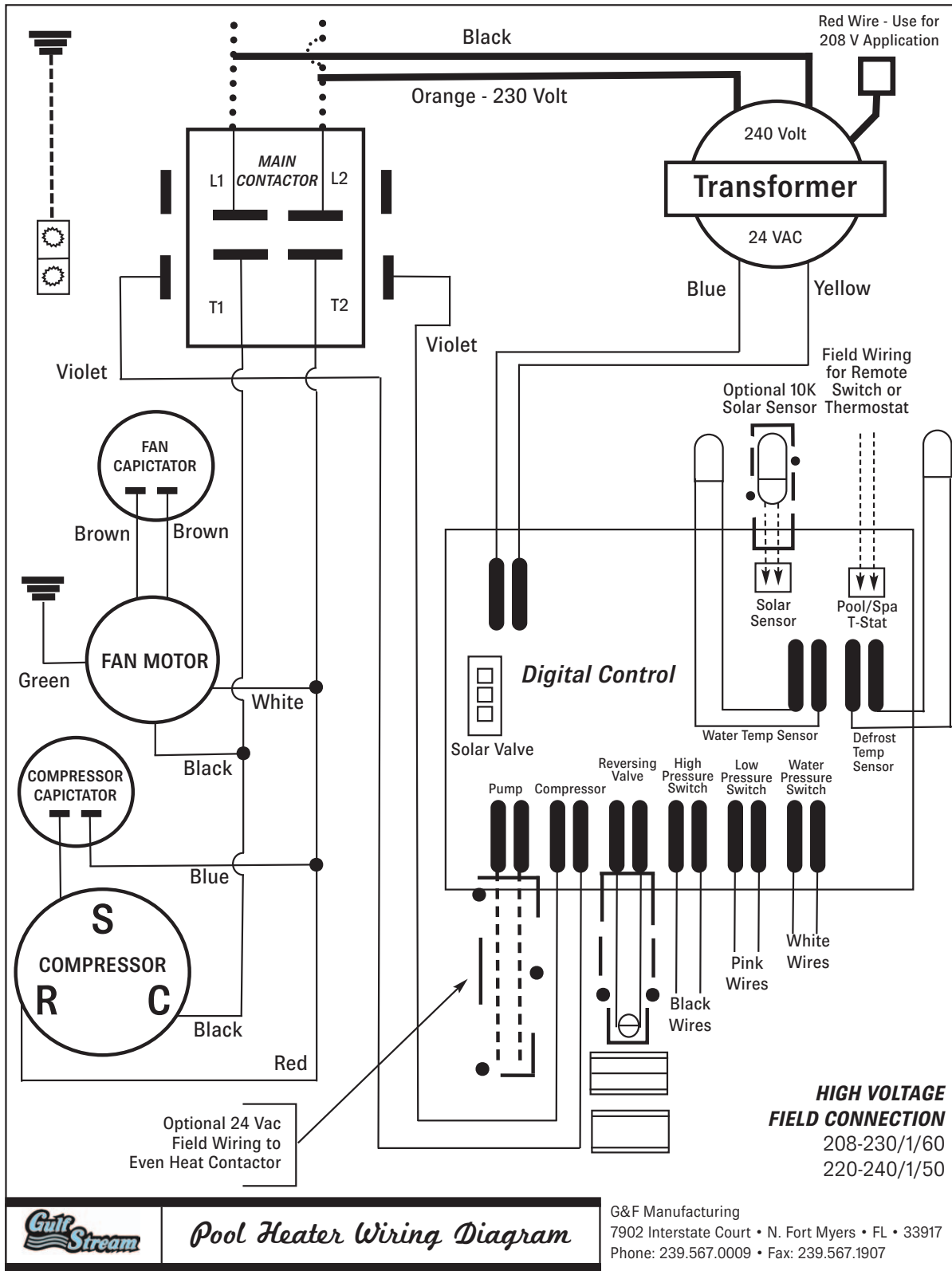

## Pool Heater Wiring Diagram

G&F Manufacturing  
7902 Interstate Court • N. Fort Myers • FL • 33917  
Phone: 239.567.0009 • Fax: 239.567.1907



G&F Manufacturing • Heat Pump Services • Do Not Call An Unauthorized Service Company to work on The GulfStream. Always Call Heat Pump Services First In Case of Any Questions. Do Not Attempt to Work on the Machine. These actions will void warranty on the unit. **HEAT PUMP SERVICES: 954.318.6900**

# DIAGRAMS

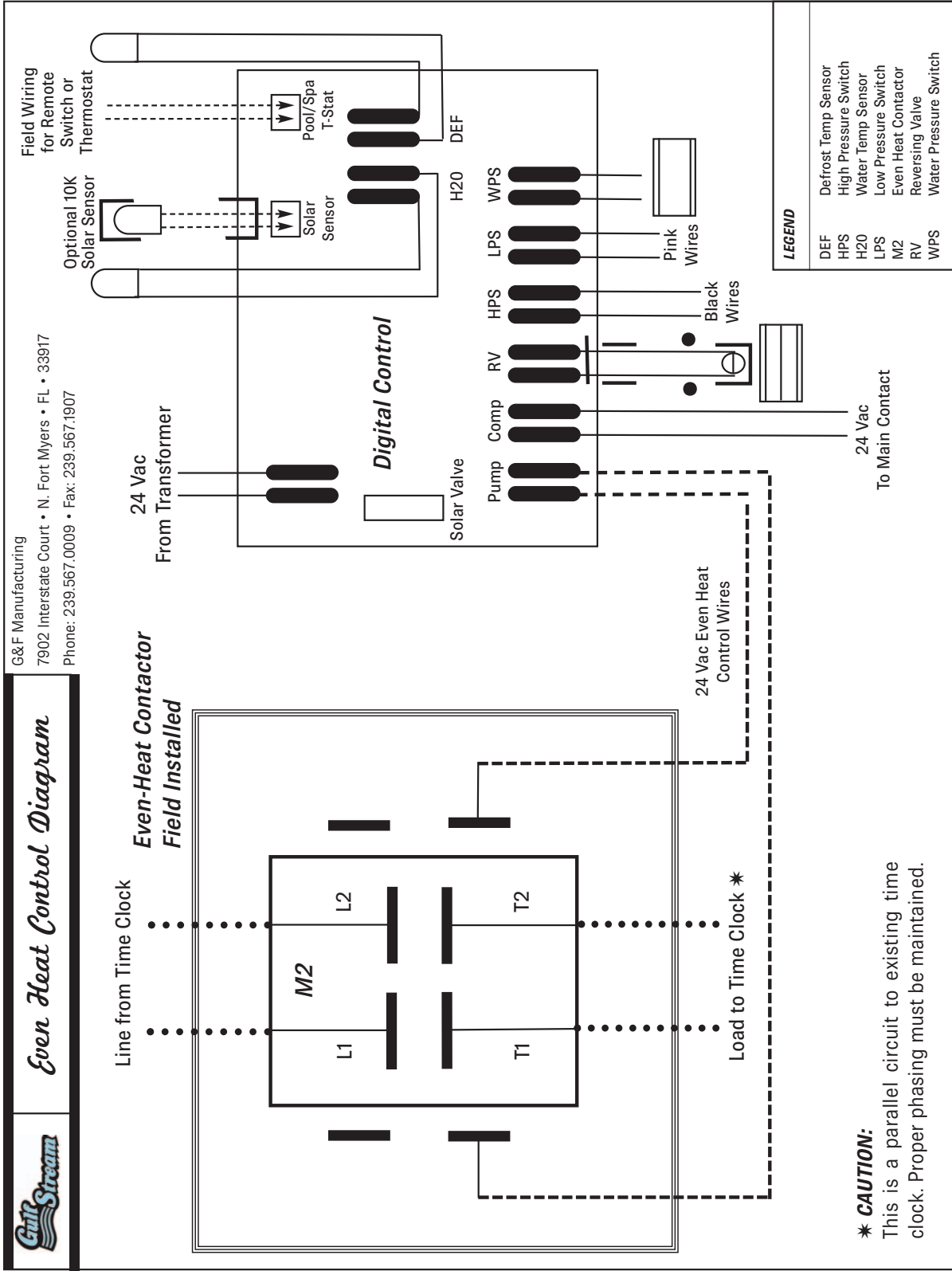



*The High Efficiency  
Ultra-Quiet Heat Pump Series  
from GulfStream*

# *Service*

***All service must be handled by  
An Authorized Service Center***

Warranty may be void if a non-authorized service representative does service.  
Do not return the heater to your dealer, as they do not provide service.

Before calling for assistance or service, please check the  
*Troubleshooting Section* of this manual or call your dealer.

This may save you the cost of a service call.  
If you still need help, follow the instructions below.

*For Service or Questions Please Contact Us*

**(954) 318-6900**

When asking for help or service please provide a detailed description  
of the problem, your heater's complete serial number, the purchase date  
and dealer purchased from.

*This information will help us respond properly to your request.*



Keep a copy of the sales receipt showing the date of purchase.  
Proof of purchase will assure you of in-warranty service.

**Manufactured By**  
G&F Manufacturing  
7902 Interstate Court  
North Fort Myers, Florida 33917