







FEATURES

- Threads into 1½" FPT
- Seals off pipes during pool finish to allow for clean threads
- Decorative option for winterizing pipes
- Manufactured from engineered polymer UV-resistant ABS material
- Silicone O-ring for extra tight seal
- 250 per case



Part # USCGxxx

STANDARD COLORS

- | | | | |
|---|-----|---|-----|
|  | 101 |  | 104 |
|  | 102 |  | 105 |
|  | 103 |  | 108 |

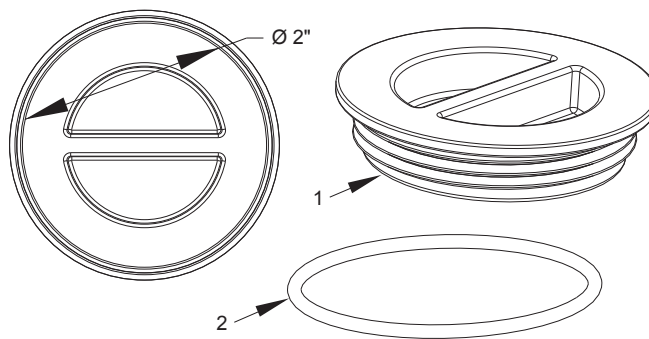

1. Umbrella stand, cap
2. O-ring