



RD



WW



ST



SQ

The MO offers the frosted glow of the PO in a larger 3LED for more light output and is the only 20 watt equivalent wall light compatible with the Luxor® system. Four interchangeable faceplates provide versatility, including use as a walkway light and recessed-style can light.

MO: Wall Lights

NUMBER OF LEDs:	1	3	ZDC
HALOGEN LUMEN EQUIVALENT:	10 Watt	20 Watt	10 Watt
USEFUL LED LIFE (L70):	50,000 hrs avg	50,000 hrs avg	50,000 hrs avg
INPUT VOLTAGE:	10 to 15V	10 to 15V	11 to 15V
VA TOTAL*: (Use number to size transformer)	2.4	4.5	7.2
WATTS USED:	2.0	4.2	6.0
LUMENS PER WATT (EFFICACY):			
RD	19	21	19
SQ	18	20	19
ST	35	43	43
WW	6	8	10
TOTAL LUMENS:			
RD	36	84	61
SQ	34	82	60
ST	68	169	137
WW	13	33	31
CRI (Ra):	82	82	82
CBCP (CENTER BEAM CANDLE POWER):			
RD	31	79	51
SQ	34	77	53
ST	34	89	67
WW	9	24	24

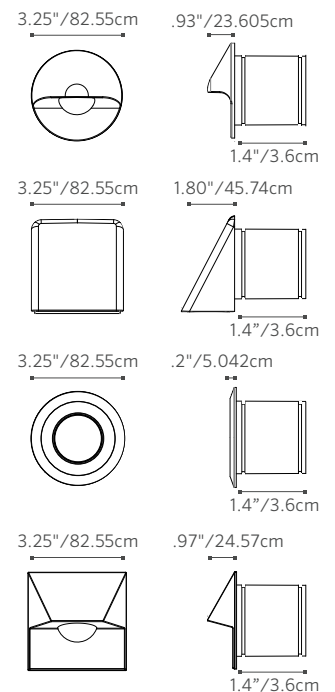

TUBE: 12" x 2.36" / 304.8 x 6cm



MO: Wall Lights

FACTORY INSTALLED OPTIONS: Order 1 + 2 (optional) + 3 + 4 + 5

Step	Description	Code
1	FIXTURE	MO
2	LUXOR OPTION	ZD, ZDC [†] (Color)
3	LAMP	1LED, 3LED, _____ [†]
4	FACEPLATE	RD (Round), WW (Wall Wash), ST (Spot), SQ (Square)
5	FINISH	AB*, AT*, NP*, BS, WG, FW, AL, BZ, DG, WI, SB, FB

EXAMPLE: **MO-ZD-1LED-RD-BZ** = MO - ZD Option - 1LED Board - Round Faceplate - Bronze Metallic Finish
[†] Fixtures specified with ZDC Technology™ are available only in one circuit board configuration.
 Do not specify a number of LEDs when ordering

FIELD INSTALLED OPTIONS: Order Individually

Mounting Options
MO Conduit Sleeve (250020600000) Included ▶
MO Mounting Bracket (MOBRKT)







MO
Conduit Sleeve











MO
Mounting Bracket

METALS

-  **AB** = Antique Bronze* (On Brass)
-  **AT** = Antique Tumbled* (On Brass)
-  **NP** = Nickel Plate*
-  **BS** = Natural Brass

POWDER COAT

-  **WG** = White Gloss
-  **FW** = Flat White
-  **AL** = Almond
-  **SV** = Silver
-  **BZ** = Bronze Metallic
-  **DG** = Desert Granite
-  **WI** = Weathered Iron
-  **SB** = Sedona Brown
-  **FB** = Flat Black

PHOTOMETRICS:

1LED

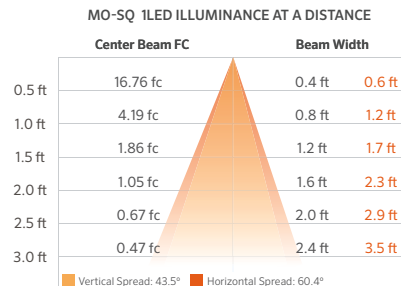
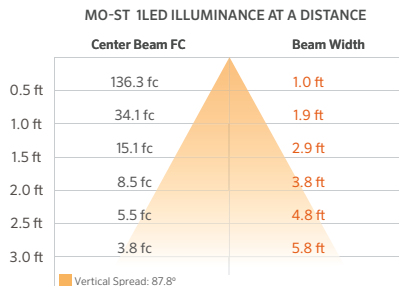
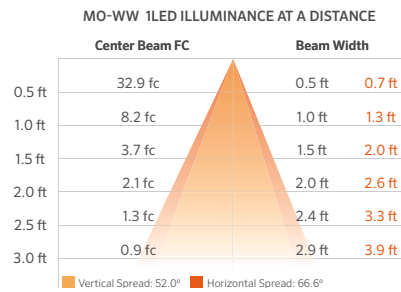
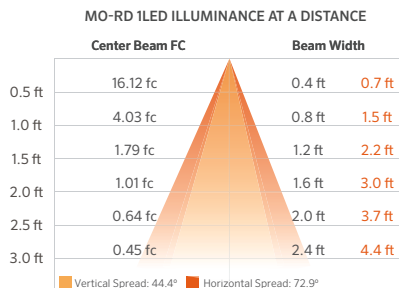

All MO wall lights come standard with amber, blue, and green filters

The MO includes a mounting conduit, 9 ft lead wire, and choice of LED board and faceplate finish.

* May require longer lead time

Photometric Charts: Beam angle is calculated using LM-79 method for SSL Luminaires: Beam angle is defined as two times the vertical angle at which the intensity is 50% of the maximum.





MO: Wall Lights

PHOTOMETRICS CONTINUED:

3LED

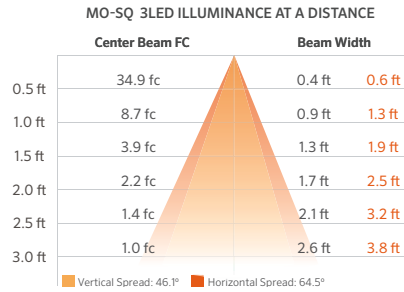
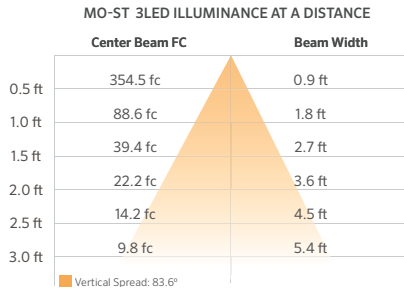
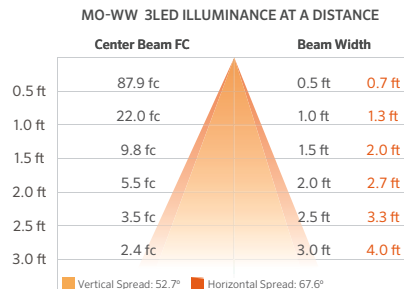
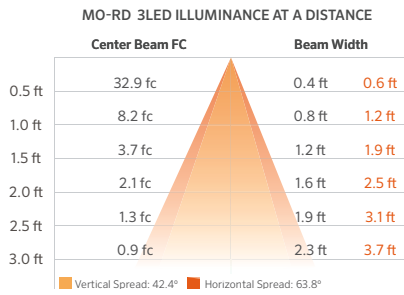

ZDC

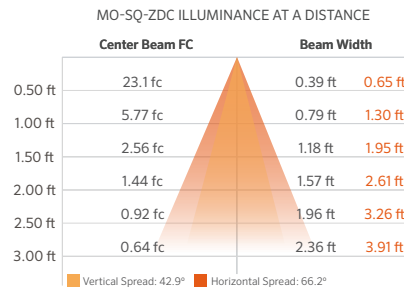
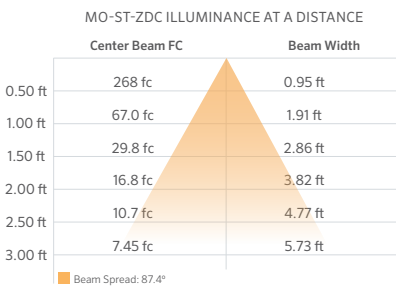
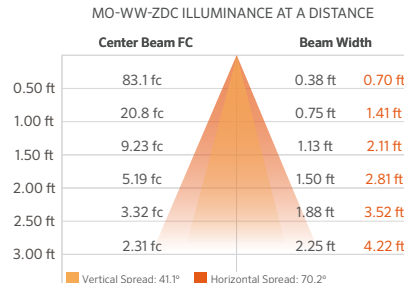
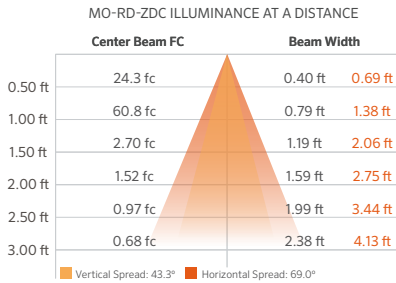

Photometric Charts: Beam angle is calculated using LM-79 method for SSL Luminaires: Beam angle is defined as two times the vertical angle at which the intensity is 50% of the maximum.