

AquaCal[®]

Operation Manual

HEATWAVE  SUPERQUIET[®]



Important

Read this document before operating / installing this product

For additional product manuals and operation / installation procedures, please visit www.AquaCal.com

MODEL / SERIAL NUMBER

Table of Contents

Section 1 - Contacting AquaCal AutoPilot, Inc.

Section 2 - Safety

Section 3 - Operation

3.1 Energizing Heat Pump	2
3.2 Display Door	2
3.3 Display Lock	2
3.4 Display Panel	2
3.4.a Buttons	3
3.4.b Indicator Lights	3
3.4.c Display	3
3.5 User Level Factory Defaults	4
3.6 Setting Operating Mode	5
3.7 Selecting Celsius or Fahrenheit	5
3.8 Setting Thermostats	5
3.9 User Lock Option (Enable)	6
3.10 User Lock Option (Disable)	7
3.11 User Lock Option (Entering Pass Code)	7
3.12 Operating Heat Pump (With an External Controller)	8

Section 4 - Maintenance

4.1 Monitoring Conditions	8
4.1.a Water Chemistry	8
4.1.b Water Flow Rates	9
4.1.c Adjusting Water Flow Using ΔT (Delta-T)	10
4.1.d Irrigation and Storm Run-Off	11
4.1.e Clearances	11
4.2 Cleaning Equipment	12
4.3 Planned Maintenance	13
4.4 Winterizing	14

Section 5 - Troubleshooting

5.1 Fault Codes	16
5.2 Issues and Resolutions	18

Section 6 - Appendix

6.1 Identifying Model Specifications	21
6.2 Initial Heating Recommendations	22
6.3 Initial Cooling Recommendations	22
6.4 Available Accessories	22

SECTION 1 - CONTACTING AQUACAL AUTOPILOT, INC.

For further assistance, please contact the installing dealer or contact AquaCal AutoPilot, Inc. for a service partner in your area. To better assist you, please have the heat pump model and serial number available. See "Identifying Model Specifications" on page 21.

Website	www.AquaCal.com
Request Service Online	www.AquaCal.com/request-heat-pump-service/
Phone	(1) 727-823-5642
Hours	8-5 pm, Eastern M-F

SECTION 2 - SAFETY

- For personal safety, and to avoid damage to equipment, follow all safety instructions displayed on the equipment and within this manual. Repair and service of heat pump must be performed by an authorized service center.
- Warranties may be voided if the equipment has been improperly installed, maintained or serviced.
- If service is deemed necessary, please contact the installing dealer. Or contact AquaCal® for a service partner in your area. See "Contacting AquaCal AutoPilot, Inc." on page 1.

SAFETY SIGNALS

Throughout this document, safety signals have been placed where particular attention is required.

 **WARNING** - signals relate to personal safety.

 **CAUTION** - signals promote avoiding damage to the equipment.

When installing and using your heat pump basic safety precautions must always be followed, including the following:

-  **WARNING** - Failure to heed the following may result in injury or death.
 - Installation and repairs must be performed by a qualified technician.
 - The heat pump contains refrigerant under pressure. Repairs to the refrigerant circuit must not be attempted by untrained and / or unqualified individuals. Service must be performed only by qualified HVAC technicians. Recover refrigerant before opening the system.
 - The heat pump utilizes high voltage and rotating equipment. Use caution when servicing.
 - Electrical installation and service should be performed by a Licensed Electrician only.
 - Improper water chemistry can present a serious health hazard. To avoid possible hazards, maintain pool / spa water per standards detailed in this document.
 - Prolonged immersion in water warmer than normal body temperature may cause a condition known as Hyperthermia. The symptoms of Hyperthermia include unawareness of impending hazard, failure to perceive heat, failure to recognize the need to exit the spa, and unconsciousness. The use of alcohol, drugs, or medication can greatly increase the risk of fatal Hyperthermia. In addition, persons having an adverse medical history, or pregnant women, should consult a physician before using a hot tub or spa. Children and the extreme elderly should be supervised by a responsible adult.
 - Prolonged immersion in water colder than normal body temperature may cause a condition known as Hypothermia. The symptoms of Hypothermia include shivering (although as hypothermia worsens, shivering stops), clumsiness or lack of coordination, slurred speech or mumbling, confusion and poor decision-making, drowsiness or low energy, lack of concern about personal welfare, progressive loss of consciousness, weak pulse and slow or shallow breathing. In addition, persons having an adverse medical history, or pregnant women, should consult a physician before immersing in a cold body of water. Children and the extreme elderly should be supervised by a responsible adult.

⚠ CAUTION - Failure to heed the following may result in equipment damage.

- Maintain proper water chemistry in order to avoid damage to pump, filter, pool shell, etc.
- Water flow exceeding maximum flow rate requires a bypass. Damage due to excessive water flow will void warranty.

SAVE THESE INSTRUCTIONS

SECTION 3 - OPERATION

3.1 Energizing Heat Pump

Turn power on at external fuse box or breaker disconnect.

- Controller performs a lamp test.
- The display reads **888**.
- Controller then displays as normal. See "Display" on page 3.

3.2 Display Door

The display panel is located in a door compartment on the front of the heat pump. This compartment is designed to protect the display against harsh weather. It can also be padlocked for extra security.

- Press the bottom of the panel to open the display panel door.
- To close, push the display panel up. Then press the bottom of the panel in until a clicking noise is heard.

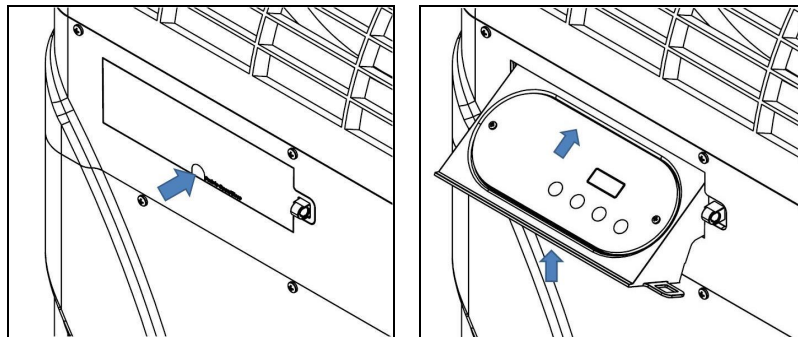

3.3 Display Lock

The heat pump has a display lock to protect against inadvertent setting changes. To activate display and controls, slide finger across the controls as shown from left to right.

- The code **UnL** will briefly appear, then the set temperature or mode will display.
- This is different than a user-lock which requires a pass code. See "User Lock Option (Enable)" on page 6.

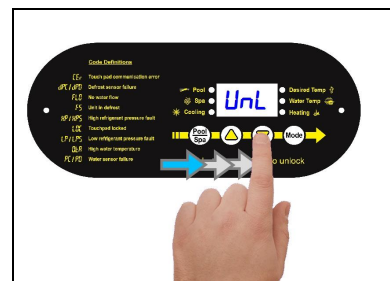

3.4 Display Panel

The following information outlines the operation for a standard installation.

- Control Buttons will operate differently for custom installations; such as a heat pump connected to an external controller. See "Operating Heat Pump (With an External Controller)" on page 8.

Display Panel

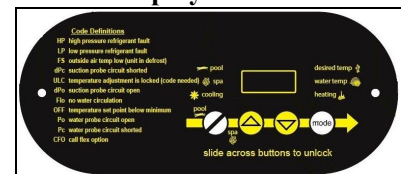

3.4.a Buttons

Buttons	Description
Display Lock	Sliding your finger across the buttons from left to right will temporarily disable the display lock.
Pool / Spa	Select either the pool or the spa thermostat.
Up Arrow	Used to increase temperature set point and navigate through menu options.
Down Arrow	Used to decrease temperature set point and navigate through menu options.
Mode	Select heat pump's operating mode.

3.4.b Indicator Lights

Indicators	Description
Pool	The Heat Pump is referencing the pool thermostat.
Spa	The Heat Pump is referencing the spa thermostat.
Heating	Indicates the unit is heating the water. Please note - the compressor must be operating before this light will illuminate.
Cooling	Indicates the unit is cooling the water. Please note - the compressor must be operating before this light will illuminate.
Water Temp	Indicates current water temperature.
Desired Temp	Indicates temperature set point is displayed. This is displayed when "UP" or "DOWN" is selected.

3.4.c Display

Display	Description
75	The heat pump is on and displaying the current water temperature. In this example 75° F is displayed.
FLO	No water flow is detected. The filter pump is off or heat pump is not receiving correct water flow.
OFF	The heat pump has been turned off via the mode selector button or the temperature set point has been lowered below 45° F.
888	The control program is initializing. This displays only as power is applied to the heat pump. The program version number will then be displayed.

Display	Description
<i>CF 1</i>	Select water temperature format (in either Celsius or Fahrenheit).
<i>ULC</i>	Enable heat pump lockout feature.
<i>ELC</i>	Select passcode to lock the keyboard.
<i>LOC</i>	This is a Service Entry Point (not intended for use by the owner). The <i>LOC</i> code permits service personnel to enter a factory passcode to access adjustable calibration and site dependent setup parameters. Service adjustments are available to authorized installation and service personnel, only.

3.5 User Level Factory Defaults

Certain programming options have been preset at the factory. These options can be overwritten for site-specific conditions.

⚠ CAUTION - Failure to heed the following may result in equipment damage.

- Unauthorized adjustments in the Installer Menu (beyond the *LOC* menu) may void heat pump's warranty.

Table 1 - Factory Defaults

CODE	DESCRIPTION	DEFAULT VALUE	RANGE
<i>OFF</i>	Heat Pump is deactivated.		
<i>HEA</i>	Set to heat water to point set on thermostat.		
<i>COO</i>	Set to cool water to point set on thermostat.		
<i>ACH</i>	Set to maintain a water temperature set on the thermostat.		
<i>CF 1</i>	Celsius / Fahrenheit Selection	1	0 = Celsius 1 = Fahrenheit
<i>ELC</i>	Enter Lock Code	0	0 - 99
<i>ULC</i>	User Lock Code	0	0 = "User Lock Disabled" 1 = "User Lock Enabled"

3.6 Setting Operating Mode

Heat Mode

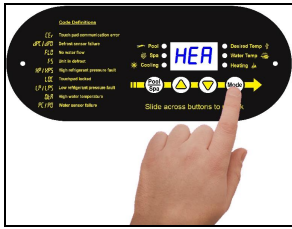

Cool Mode

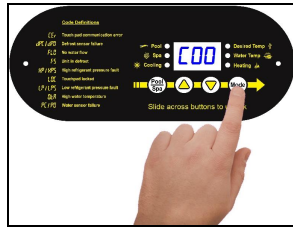

Automatic Heat / Cool Mode

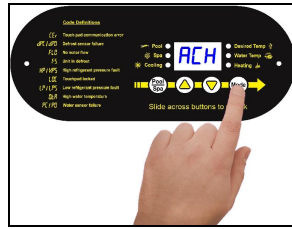

Deactivate Heat Pump

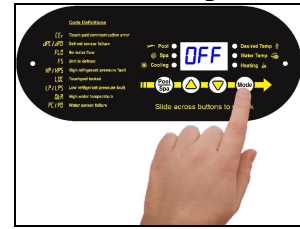

Heating / Cooling modes only available on select equipment. Confirm heat pump features before setting a mode.

3.7 Selecting Celsius or Fahrenheit

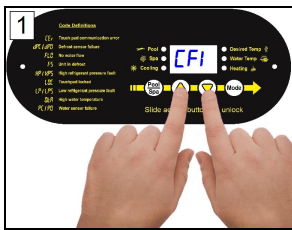

Hold "UP" and "DOWN" until **CF** displays.

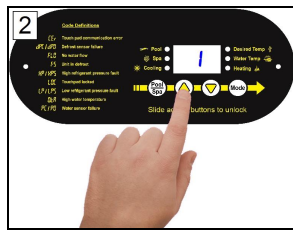

Press "UP" or "DOWN" button to select.
 "0" - Celsius
 "1" - Fahrenheit

3.8 Setting Thermostats

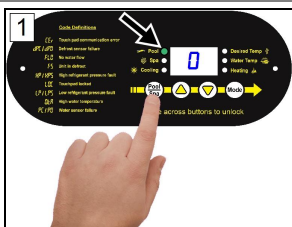

Select "POOL" or "SPA"

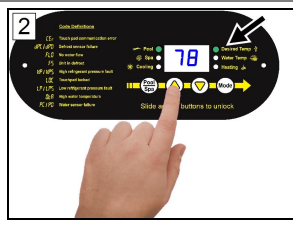

Press "UP" or "DOWN" to the desired temperature.

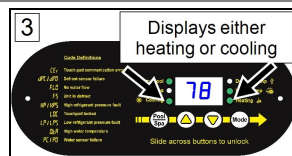

- The heating indicator will illuminate when heating the water.
- The cooling indicator will illuminate when cooling the water.

3.9 User Lock Option (Enable)

The user-lock feature allows the heat pump display panel to be "locked". This can prevent unauthorized temperature adjustments in commercial applications.

- Do not confuse a user-lock with the display lock. See "Display Lock" on page 2.
- If **LDC** is briefly displayed, followed by a "0", the heat pump is already locked.
- If the user-lock code has been misplaced, please contact AquaCal® Customer Service for further assistance.

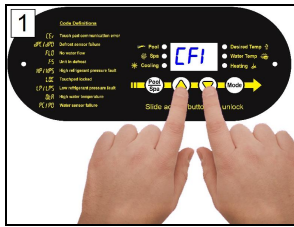

Hold "UP" and "DOWN" until **CFI** displays.

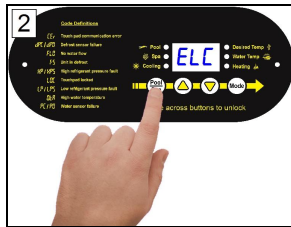

Press "POOL / SPA" button until **ELC** is displayed.



Press "UP" or "DOWN" button to change or add a numerical password

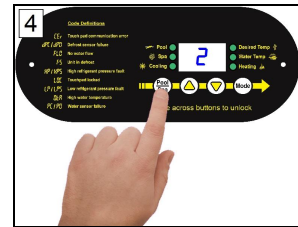

Press "POOL / SPA" button to lock in the password.

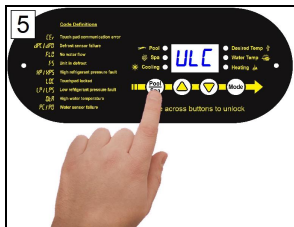

Press "POOL / SPA" button until **ULC** is displayed.

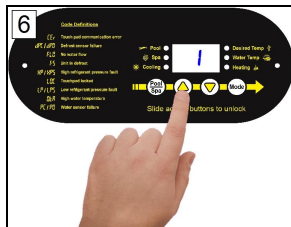

Press "Up" button till "1" is displayed to enable.

3.10 User Lock Option (Disable)

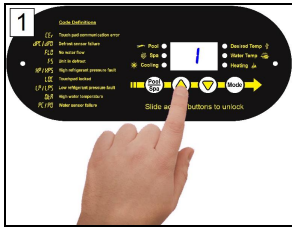

Use "UP" button to enter existing password.

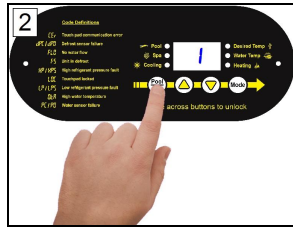

Press "Pool / Spa" button to unlock.

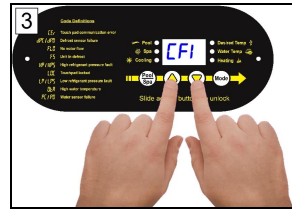

Hold "UP" and "DOWN" buttons until **CF 1** is displayed.

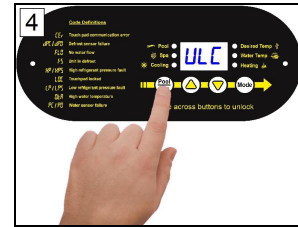

Press "POOL / SPA" button until **ULL** is displayed

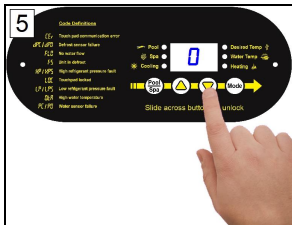

Press "DOWN" button until "0" is displayed.

3.11 User Lock Option (Entering Pass Code)

If **LOC** is briefly displayed when attempting to change a heat pump's settings followed by a "0", the heat pump is in a user-lock mode. A numerical passcode is required to proceed.

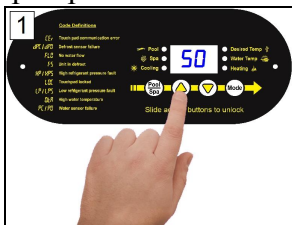

Press "UP" or "DOWN" arrow to enter user lock code.



Press "POOL / SPA" button to unlock.

NOTE -

- After three seconds of inactivity, the heat pump's display lock will activate. See "Display Lock" on page 2.
- If the user-lock code has been misplaced, please contact AquaCal® Customer Service for further assistance.

3.12 Operating Heat Pump (With an External Controller)

Controller with an internal thermostat control

Activating Heat Pump

1. Set the desired temperature at the external controller.
2. Use the external controller to select either the "Pool" or "Spa" to heat.

Deactivating Heat Pump

- Set the external controller to "OFF".

Please note - If equipped, the heat pump's cooling function **will be disabled** when using this type of controller.

If the cooling function is needed, the heat pump must be temporarily re-programmed for local control. Check with controller installer if heat pump needs to be re-programmed.

Controller with 2 positions - ("Pool" and "Spa" - no internal thermostat control)

Activating Heat Pump

1. Set the desired temperatures on the heat pump thermostats. See "Setting Thermostats" on page 5.
2. Use the external controller to select either the "Pool" or "Spa" to heat.
 - *Rapid movement between thermostats without a "rest" between each change can cause a missed signal by the heat pump.*

Deactivating Heat Pump

- Go to the heat pump and set the mode to "OFF". See "Setting Operating Mode" on page 5.

Please note - If equipped, the heat pump's cooling function **will be disabled** when using this type of controller.

If the cooling function is needed, the heat pump must be temporarily re-programmed for local control. Check with controller installer if heat pump needs to be re-programmed.

Controller with 3 positions - ("High", "Low", and "Off" - no internal thermostat control):

Activating Heat Pump

1. Set the desired temperatures on the heat pump thermostats. See "Setting Thermostats" on page 5.
2. Use the external controller to select either "High" or "Low" to heat.
 - *When changing between thermostats, select "Off" first. Then select desired thermostat.*
 - *Rapid movement between thermostats without a "rest" between each change can cause a missed signal by the heat pump.*

Deactivating Heat Pump

- Set the external controller to "OFF".

SECTION 4 - MAINTENANCE

4.1 Monitoring Conditions

4.1.a Water Chemistry

Check water chemistry regularly and maintain within recommended levels. Standards for commercial applications vary in different areas. Follow all local applicable codes.

 **CAUTION** - Failure to heed the following may result in equipment damage.

- Do not allow water to flow through heat pump when refinishing or acid washing a pool. Either use an installed bypass to route water away from heat pump or deactivate filter pump.
- To avoid damage to equipment, monitor and maintain chemistry within recommended levels.

CHEMISTRY LEVEL CHART (RESIDENTIAL)		
CHEMICAL	POOLS	SPAS
Chlorine	1.0 – 3.0 ppm	3.0 – 5.0 ppm
Bromine	2.0 – 6.0 ppm	2.0 – 6.0 ppm
Cyanuric Acid	30 - 50 ppm	30 - 50 ppm
pH	7.4 – 7.6 ppm	7.4 – 7.6 ppm
Total Alkalinity	80 – 120 ppm	80 – 120 ppm
Calcium Hardness	200 – 400 ppm	150 – 250 ppm
Total Dissolved Solids*	0 – 1,500 ppm	1,500 ppm above start-up total dissolved solids in spas

* Salt from a chlorine generator is not included in Total Dissolved Solids.

4.1.b Water Flow Rates

Maintain water flow rates as indicated. Please note, these specifications relate to the heat pump only. Code-specified whole system turnover rates must be satisfied.

⚠ CAUTION - Failure to heed the following may result in equipment damage.

- Water flow exceeding maximum flow rate may damage heat exchanger; such damage will not be covered under the equipment warranty

MODEL	HEAT EXCHANGER TYPE	FLOW RATES	
		MINIMUM	MAXIMUM
SQ120R	Titanium ThermoLink®	30 GPM	70 GPM
SQ125	Titanium ThermoLink®	30 GPM	70 GPM
SQ145	Titanium ThermoLink®	30 GPM	70 GPM
SQ166R	Titanium ThermoLink®	30 GPM	70 GPM
SQ225	Titanium ThermoLink®	30 GPM	70 GPM
T035	Titanium Tube-in-Tube	20 GPM	45 GPM
T055	Titanium Tube-in-Tube	20 GPM	45 GPM
T075	Titanium Tube-in-Tube	20 GPM	45 GPM
T090	Titanium ThermoLink®	30 GPM	70 GPM
T115	Titanium ThermoLink®	30 GPM	70 GPM
T135	Titanium ThermoLink®	30 GPM	70 GPM

If water flow through the heat pump is reduced, performance will suffer and internal safety devices may deactivate the heat pump with error codes **HP** and **HPS**, or (if equipped) an **LP** and **LPS**.

- Operate water filtration devices per manufacturer's specifications. Dirty filters can cause reduced water flow to the heat pump. An increase of 7-10 psi higher than the clean filter pressure typically reduces flow rates. This requires the filter to be cleaned or back-washed
- Keep baskets free of debris. Similar to a dirty filter, large volumes of debris in the pump and skimmer baskets can reduce water flow.
- Check for improper valve settings. A partially closed valve after the filter, or a full-open bypass around the heat pump, will cause insufficient water flow through the heat pump.
- The maximum static (or operating pressure) is 50 pounds-per-square-inch (PSI). These specifications relate to the heat pump only. Code-specified whole system turnover rates must be satisfied.

4.1.c Adjusting Water Flow Using ΔT (Delta-T)

The Delta-T is the temperature difference between the water temperatures entering and leaving the heat pump. The equipment can be fine-tuned for maximum performance by balancing water flow rates to maintain an ideal ΔT .

- Installed Temperature / Pressure probes and ports are required to perform the following procedures.
- **This adjustment procedure is to be completed with the unit in HEA mode only; ACH and COO discharge temperatures are not shown.**

PLEASE NOTE -

*Temperature / Pressure ports are required for all commercial applications.
They are strongly recommended (but not required) for residential installations.*

1. Adjust heat pump thermostat to its lowest setting while in **HEA** mode.
2. Deactivate the water filtration pump.
3. Adjust valves to a halfway open position leading to the heat pump.
4. Adjust valves to a fully open position leading away from the heat pump.
5. Activate the pool water filtration pump.
6. Slowly turn the thermostat up until the heat pump activates.
 - After a four-minute delay, the heat pump compressor will start.
7. With the heat pump running, confirm water filtration pump is operating properly with adequate flow and no short cycling. If needed, clean filters leading to the heat pump.
8. Wait for water and refrigerant pressure to stabilize (approximately 5 minutes).
9. Adjust valves in the following order:
 - A. Adjust valve leading away from the heat pump to correct temperatures measured with a temperature pressure probe.
 - B. Allow pressure to stabilize . Then check temperature again. Re-adjust valve leading away from the heat pump as needed.
10. Mark valves at these positions for future reference.

**Temperature / Pressure Port
(Shown with Probe)**



Temperature differences are based on pool temperatures of 72° (+ or - 3° F). For water temperatures outside this range, contact AquaCal® Technical Support.

MODEL	TEMPERATURE
SQ120R	3° to 7° F
SQ125	3° to 7° F
SQ145	3° to 7° F
SQ166R	3° to 8° F
SQ225	4° to 9° F
T035	1° to 4° F
T055	2° to 5° F
T075	3° to 7° F
T090	3° to 6° F
T115	3° to 7° F
T135	4° to 8° F

Table 2 - Temperature Chart

4.1.d Irrigation and Storm Run-Off

- Irrigation water may damage heat pump components. Have irrigation water directed away from the heat pump.
- The heat pump will withstand normal rainfall. Do not allow a roof slope to direct rainwater onto the heat pump. Have a gutter installed on the roof edge to direct this water away from the heat pump. Or install the heat pump in another location.

4.1.e Clearances

- Proper air circulation is required for the heat pump to operate efficiently. Avoid placing objects near or on top of the heat pump. This includes shrubbery and lawn furniture. These objects will also hinder maintenance access.
- Avoid storing chemical containers near the heat pump. The chemicals can cause equipment damage.

Overhead Clearance

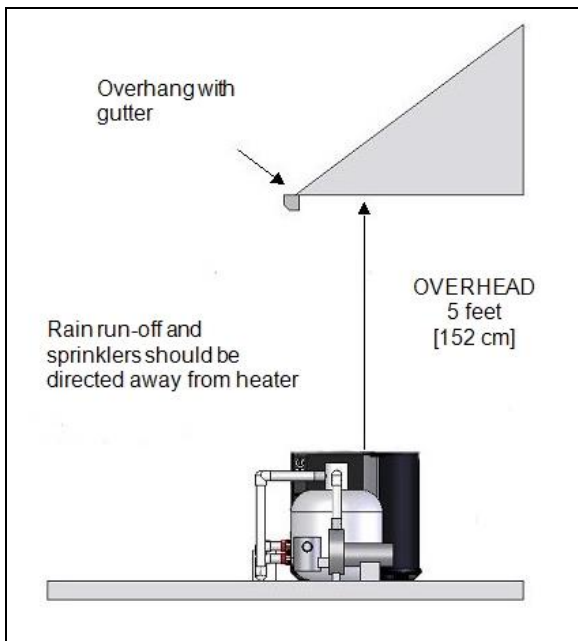

HeatWave SuperQuiet® and TropiCal® (Top View)

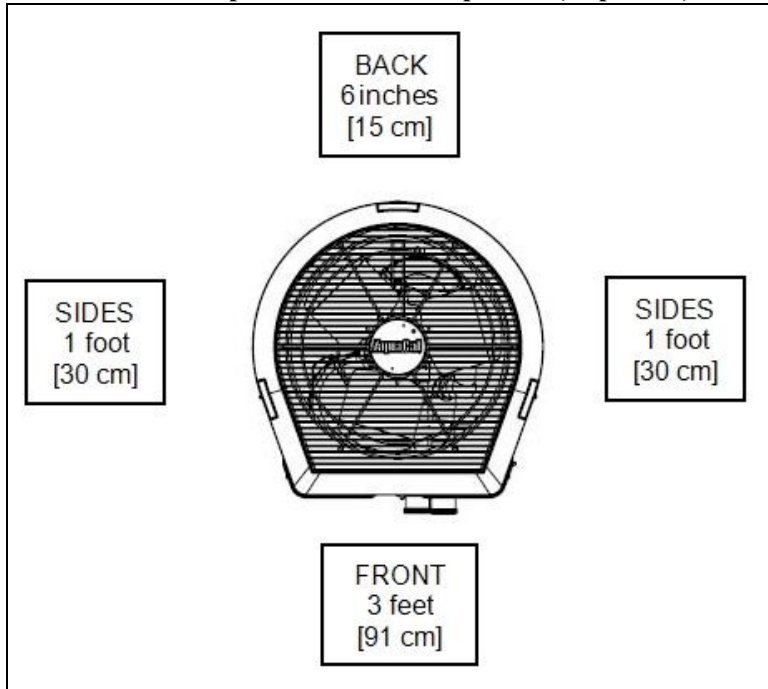

4.2 Cleaning Equipment

Cleaning and polishing your heat pump regularly can protect its appearance and longevity. More frequent servicing may be required for heat pumps located in sandy or coastal areas where sand and salt spray can become detrimental factors to equipment.

⚠ WARNING - Failure to heed the following may result in injury or death.

- Possible electric shock hazard - Deactivate power to all electrical devices on the pad when washing heat pump. Do not restore electrical power until equipment is completely dry.

⚠ CAUTION - Failure to heed the following may result in equipment damage.

- Do not use a pressure cleaner to wash heat pump. Damage to heat pump components may result. If using a hose-end spray nozzle adjust spray pattern to low strength only.
- Do not spray water directly into the interior of the heat pump; damage to components may result.
- Do not use chemicals on the display panel.

Cleaning

1. Wash outside cabinet using a low-pressure water hose. A high-pressure water stream will cause damage to the aluminum fins of the heat pump. This damage is not covered under product warranty.
2. While the heat pump is still wet, use an approved cleaning agent to clean the exterior of the heat pump. **Do not use chemicals on the display panel.**
3. Use a detergent-dampened cloth to wipe the heat pump's exterior cabinet.
4. Flush all exterior with fresh water using a low-pressure water hose.
5. Dry the exterior cabinet using a soft cloth being careful not to damage evaporator fins.

APPROVED CLEANING AGENTS*
Fantastic®
Formula 409®
Cascade®
All Power Plain Detergent (3% Solution)

Table 3 - Cleaning Agents

Polishing

1. Polish the heat pump's cabinet panels using an approved polishing agent and following the manufacturer's instructions. Do not use chemicals on the display panel.
2. Rinse the heat pump panels with fresh water, wipe, and buff panels using a dry soft cloth.
3. Allow heat pump interior and surrounding equipment to "air-dry" for several hours prior to restoring electrical power.

APPROVED POLISHING AGENTS*
Simoniz® Wax
Glo-Coat®
Armor All® Protectant

Table 4 - Polishing Agents

- * The trademarks used in approved cleaning and polishing agents are property of their owners and are not related to AquaCal®.

4.3 Planned Maintenance

An annual inspection and maintenance program is strongly recommended starting no longer than one year after installation of the heat pump. In coastal areas a bi-annual inspection is recommended. See recommended inspection checklist.

AquaCal® can perform this service in limited areas. Contact Customer Support for more information.

⚠ WARNING - Failure to heed the following may result in injury or death.

- Annual inspection and service must be performed by a qualified heat pump specialist in order to prevent physical injury or damage to equipment.

RECOMMENDED INSPECTION CHECKLIST:

- Check Air Temperature Change through Evaporator
- Check and Clean Condensate Drains
- Check Capacitor Value
- Check Compressor Amperage Draw
- Check Electrical Connections
- Check Flow / Pressure Switch
- Check Operating Controls and Temperature Sensors
- Check Water Chemistry
- Check Proper Voltage to Unit
- Check Refrigerant Levels
- Check Relay Contacts
- Check Water Flow
- Check filter pump Amperage Draw
- Check Water Temperature Change through Heat Exchanger
- Clean Evaporator's Coil
- Clean Heat Pump's Cabinet

4.4 Winterizing

- ⚠ WARNING** - Failure to heed the following may result in injury or death.
- Deactivate all electrical power to heat pump before performing hard freeze procedures.

- ⚠ CAUTION** - Failure to heed the following may result in equipment damage.
- Failure to winterize heat pump may result in serious equipment damage. Freeze damage is not covered under the heat pump warranty.
 - While the plumbing connections are in the winterized condition (not fully tightened), it is imperative the pool and spa water not be circulated through the heat pump. Loss of water through loose plumbing connections may result in damage to circulation pump, pool and spa structures, and other equipment.

Light Freeze Conditions

There are two freeze conditions requiring heat pump attention. A light freeze is when the ambient air temperature falls below 32 degrees Fahrenheit for less than 8 hours. Typically during light freeze conditions circulating (moving) water will not freeze. Override time clocks and allow filtration system to run continuously during light freeze conditions.

Hard Freeze Conditions

A hard freeze is when the ambient air temperature falls below 32 degrees Fahrenheit for more than 8 hours. In areas where this condition is prevalent and sustained, the heat pump **MUST** be winterized for hard freeze conditions. Follow the correct procedure depending on the type of heat exchanger found in the heat pump.

Identify Exchanger:

1. Deactivate all electrical power to heat pump.
2. Deactivate filter pump.
3. Remove front access panel.
4. Identify heat pump exchanger from illustrations in this section. Then follow procedure for that heat pump's exchanger.

Titanium ThermoLink® Exchanger (with Internal Drain)

1. Disconnect the plumbing to the heat pump at connection unions (removal is counter-clockwise).
2. Remove internal drain plug.
3. Allow water to drain completely from the heat pump. Expect to see a lot of water drain out at first, and then a small amount to continue to drain out over a long period.
4. After heat pump is fully drained, re-connect internal drain plug and reinstall front access panel.
5. Partially reconnect plumbing connection unions.
6. Winterizing is complete.
7. When ready to use heat pump again, hand-tighten connection unions. Reconnect electrical power, and set the operating mode on the heat pump. Activate filter pump.

**Internal
Drain**

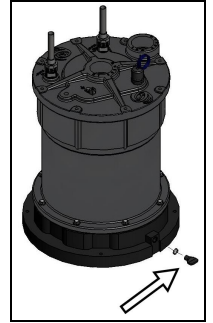

Titanium ThermoLink® Exchanger (with no Drain)

1. Reinstall front access panel.
2. Disconnect the plumbing to the heat pump at connection unions (removal is counter-clockwise).
3. Allow water to drain completely from the heat pump. Expect to see a lot of water drain out at first, and then a small amount to continue to drain out over a long period.
4. After heat pump is fully drained, reinstall front access panel.
5. Partially reconnect plumbing connection unions.
6. Winterizing is complete.
7. When ready to use heat pump again, hand-tighten connection unions. Reconnect electrical power, and set the operating mode on the heat pump. Activate filter pump.

No Drain



Titanium Tube-in-Tube Exchanger

1. Disconnect the plumbing to the heat pump at connection unions (removal is counter-clockwise).
2. Allow water to drain completely from the heat pump. Expect to see a lot of water drain out at first, and then a small amount to continue to drain out over a long period.
3. Place an air hose into the pool inlet of the heat pump; wrap a clean rag around the hose to form a temporary seal.
4. Push all water from the water circuit using compressed air no stronger than 50 psig. The residual water should be forced out of the pool outlet. Allow compressed air to blow into the heat pump inlet for at least 15-20 seconds after the water stops coming out.
5. Repeat process on the outlet side of the heat pump.
6. Partially reconnect plumbing connection unions.
7. Winterizing is complete.
8. When ready to use heat pump again, hand-tighten connection unions. Reconnect electrical power, and set the operating mode on the heat pump. Activate filter pump.

**Titanium
Tube-in-
Tube**

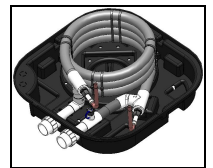

SECTION 5 - TROUBLESHOOTING

5.1 Fault Codes

A fault code indicates a specific issue or condition that will require action before the equipment can resume operating.

Please perform the following troubleshooting.

If the issue reoccurs, please contact the installing dealer. Or contact AquaCal® for a service partner in your area. See "Contacting AquaCal AutoPilot, Inc." on page 1.

⚠ WARNING - Failure to heed the following may result in injury or death.

- Repairs must not be attempted by untrained or unqualified individuals.
- The heat pump contains refrigerant under high pressure. Repairs to the refrigerant circuit must not be attempted by untrained or unqualified individuals. Service must be performed only by qualified HVAC technicians. Recover refrigerant before opening the system.

⚠ CAUTION - Failure to heed the following may result in equipment damage.

- Service by unauthorized personnel will void the heat pump warranty.

FLO Indicator

ISSUE

Low or no water detected.

RESOLUTION

1. Confirm the filter pump is on.
2. If a multiple-speed filter pump is being used, run at a higher speed to determine if the error persists. Do not exceed maximum flow rate for your model.
3. Confirm water is not being diverted away from the heat pump.
 - See "Water Flow Rates" on page 9.
 - See "Adjusting Water Flow Using ΔT (Delta-T)" on page 10.

CEr Indicator

ISSUE

This can indicate a loose or damaged communication cable.

RESOLUTION

A qualified technician should check the cable from control board to display assembly for a loose connection or visible damage.

CSE Indicator

ISSUE

This is a control system error.

RESOLUTION

Deactivate then reactivate power to reset controls.

dPC or dPD Indicator

ISSUE

Shorted or open defrost sensor.

RESOLUTION

A qualified technician should replace the defrost sensor.

PC or PO Indicator

ISSUE

Shorted or open water sensor.

RESOLUTION

A qualified technician should replace the water sensor.

HP Indicator

ISSUE

The refrigerant system's high-pressure switch is showing as open.

RESOLUTION

If the heat pump is a reversing unit, place it in **HEA** mode and perform the following troubleshooting.

Determine if an insufficient amount of water is being supplied to the equipment.

1. Confirm the filter pump is on.
2. If a multiple-speed filter pump is being used, run filter pump at a higher speed. Do not exceed maximum flow rate for the model.
3. Confirm water is not being diverted away from the heat pump.
 - See "Water Flow Rates" on page 9.
 - See "Adjusting Water Flow Using ΔT (Delta-T)" on page 10.

HPS Indicator

ISSUE

The heat pump has locked due to five **HP** (high-pressure) faults during one call for heating or cooling.

RESOLUTION

1. Deactivate then reactivate power to the heat pump to clear error.
2. Troubleshoot the high-pressure issue causing the error. See "HP Indicator" on page 17.

LP Indicator

ISSUE

The refrigerant system's low-pressure switch is showing as open.

RESOLUTION

If the heat pump is a reversing unit, place it in **HEA** mode and perform the following troubleshooting.

1. Check for proper fan operation. If fan is not operating, contact AquaCal® Technical Support.
2. Check for obstructed air flow around the heat pump. See "Clearances" on page 11.
3. Check for dirty or blocked evaporator coil. See "Cleaning Equipment" on page 12.
4. Check for signs of ice buildup on the coil.

LPS Indicator

ISSUE

The heat pump has locked due to five **LP** (low-pressure) faults during one call for heating or cooling.

RESOLUTION

1. Deactivate then reactivate power to the heat pump to clear error.
2. Troubleshoot the low-pressure issue causing the error. See "LP Indicator" on page 17.

DLA Indicator

ISSUE

Incoming water temperature exceeded 110° F and the unit is locked with an **DLA** over temperature alarm. The heat pump will not operate until incoming water temperature drops to 100° F or lower.

RESOLUTION

1. Determine if another heat source (gas heater, solar heater, etc.) is heating water being sent directly to the heat pump with the **DLA** indicator. This situation will need to be corrected before continuing.
2. Rule out an incorrect reading from the water temperature sensor. Verify existing water temperature with an accurate thermometer. If heat pump's sensor is inaccurate, the water temperature sensor may require replacement.

5.2 Issues and Resolutions

⚠ WARNING - Failure to heed the following may result in injury or death.

- Repairs must not be attempted by untrained or unqualified individuals.
- The heat pump contains refrigerant under pressure. Repairs to the refrigerant circuit must not be attempted by untrained or unqualified individuals. Service must be performed only by qualified HVAC technicians. Recover refrigerant before opening the system.

⚠ CAUTION - Failure to heed the following may result in equipment damage.

- Service by unauthorized personnel will void the factory warranty.

Please perform the following troubleshooting.

For further assistance, please contact the installing dealer. Or contact AquaCal® for a service partner in your area. See "Contacting AquaCal AutoPilot, Inc." on page 1.

Display Panel Not Responding

1. If the heat pump is controlled by an external controller, confirm the external controller settings. See "Operating Heat Pump (With an External Controller)" on page 8.
2. If the issue is still occurring, contact the installer or manufacturer of the external control device.

Heat Pumps Not Running

1. Confirm equipment is receiving power. Is the heat pump display illuminated?
 - If not, confirm the main breaker (located at the power supply panel) and the disconnect switch (located near the heat pump) are both turned on.
 - If the display still does not illuminate, it is recommended that the heat pump installer or electrician confirms heat pump is receiving power.
2. Confirm correct mode is selected. See "Setting Operating Mode" on page 5.
3. Confirm thermostat is set correctly. See "Setting Thermostats" on page 5.
 - If heating the water, the thermostat should be set above the current water temperature.
 - If cooling the water, the thermostat should be set below the current water temperature.
4. If an error code is displayed, diagnose and correct the cause of the code. See "Fault Codes" on page 16.
5. If the heat pump is using an external controller, the heat pump may not be set correctly to accept the controller's signal.
 - See "Operating Heat Pump (With an External Controller)" on page 8.

Heat Pumps Tripping Breaker

1. Have an electrician confirm breakers are in good condition and properly sized for the heat pump.
2. Multiple heat pumps installed at the same site may benefit from special automatic sequencing controllers to avoid excessive power drops at start-up. See "Automatic Sequencing Controller" on page 22.
3. If a fault occurs immediately when the compressor starts, a qualified technician should evaluate the system.

Heat Pump Won't Shut Off

PLEASE NOTE

*When heat pump is set to "OFF", the display will show either the water temperature or **FLD**.*

1. Confirm the heat pump has reached the desired temperature set on the thermostat. The heat pump will continue to run until the set temperature is reached.
2. If the heat pump is using an external controller, it may not be set correctly.
 - See "Operating Heat Pump (With an External Controller)" on page 8.

Heat Pump Is Running, Not Heating

1. If the heat pump is using an external controller, confirm it is set correctly.
 - See "Operating Heat Pump (With an External Controller)" on page 8.
 - If the heat pump is still not running correctly with this device, contact the installer of the external controller device or the device's manufacturer for further assistance.
2. Confirm heat pump mode is set to **HEA** operating mode.
3. Confirm thermostat is set to the desired water temperature.
4. Confirm valves are correctly positioned to heat the correct body of water (either the pool or the spa). If heating a spa that overflows into a pool, confirm the spa is isolated when being heated (not flowing into the pool).
5. Confirm heat pump is transferring heat into the water.
 - Measure the temperature of air discharge coming out of heat pump fan. If discharge air is between 8° to 10° colder than the outside ambient air (entering air), then the heat pump is moving heat into the water.
6. If an error code is displayed, diagnose and correct cause of code. See "Fault Codes" on page 16.
7. Confirm that filter pump has a sufficient run-time. The heat pump will not run (or heat the water) without water flow. Heat Pump equipment will generally be set to run 24 hours a day in commercial applications. See "Initial Heating Recommendations" on page 22.
8. If heating a spa, deactivate air blower or venturi (if equipped) to allow for quicker heating times. For pools, deactivate water features, such as slides, waterfalls, or fountains to allow water to retain heat. Use of a liquid pool blanket product, such as an Aqua Blanket™, can also compensate for excessive heat loss. See "Liquid Blankets" on page 23.

Heat Pump Is Running, Not Cooling (Reversing Models)

1. If the heat pump is using an external controller, confirm the heat pump is programmed properly to allow for cooling. See "Operating Heat Pump (With an External Controller)" on page 8.
2. Confirm the heat pump mode is set to **COO** operating mode.
3. Confirm the thermostat is set below the current water temperature.
4. Confirm valves are correctly positioned to cool the correct body of water (either the pool or the spa). If cooling a spa that overflows into a pool, confirm the spa is isolated when being cooled (not flowing into the pool).
5. If an error code is displayed, determine and correct the condition causing the code. See "Fault Codes" on page 16.
6. Confirm heat pump is transferring heat out of the water.
 - Measure the temperature of air discharge coming out of heat pump fan. If discharge air is between 8° to 10° warmer than outside ambient air (not coming out of heat pump), then the heat pump is moving heat out of the water.
7. Confirm that filter pump has a sufficient run-time. The heat pump will not run (or cool the water) without water flow. Heat Pump equipment will generally be set to run 24 hours a day in commercial applications. See "Initial Cooling Recommendations" on page 22.

Water Coming From Heat Pump

The water may be normal condensation produced as a by-product of the heat pump's refrigeration process. The heat pump can produce 8 to 10 gallons of condensation per day depending on the humidity of the ambient air. Determine if the water is condensation or a possible leak.

1. If using chlorine or bromine as a pool / spa sanitizer, use a test strip in the water at heat pump to determine if sanitizer is present. If sanitizer is present, a leak may exist.
2. Deactivate heat pump, leaving the filter pump on. After several hours, determine if water is still coming from the heat pump.

SECTION 6 - APPENDIX

6.1 Identifying Model Specifications

1. Find Data Plate - The data plate is usually posted on the side of the equipment or the inside of the heat pump's access plate.
2. Find the model number on the data plate. The first letters and numbers indicate the model type.
3. The complete model number identifies the equipment's specifications.

Data Plate Example

MINIMUM CIRCUIT AMPACITY	<input type="text"/>	MADE IN THE USA
ELEC. SERVICE: VOLTS	<input type="text"/>	PH <input type="text"/> HZ <input type="text"/>
MAXIMUM TIME DELAY FUSE OR HACR BREAKER <input type="text"/> 5		
COMPRESSOR VOLTS	<input type="text"/>	R.L.A. <input type="text"/> L.R.A. <input type="text"/>
FAN MOTOR VOLTS	<input type="text"/>	H.P. <input type="text"/> F.L.A. <input type="text"/>
REFRIGERANT: Circuit - Factory charged <input type="text"/> Only oz/Kg <input type="text"/>		
Tested to <input type="text"/> psig High side / <input type="text"/> psig Low side		
OUTDOOR USE		
AQUA CAL, INC A TEAM HORNER COMPANY 2737 24 TH STREET NORTH ST. PETERSBURG, FL 33713 FACTORY SERVICE 727-523-5642		MODEL NUMBER <input type="text"/> IIIBAR CODEIII SERIAL NUMBER <input type="text"/> IIIBAR CODEIII

Model Number Example

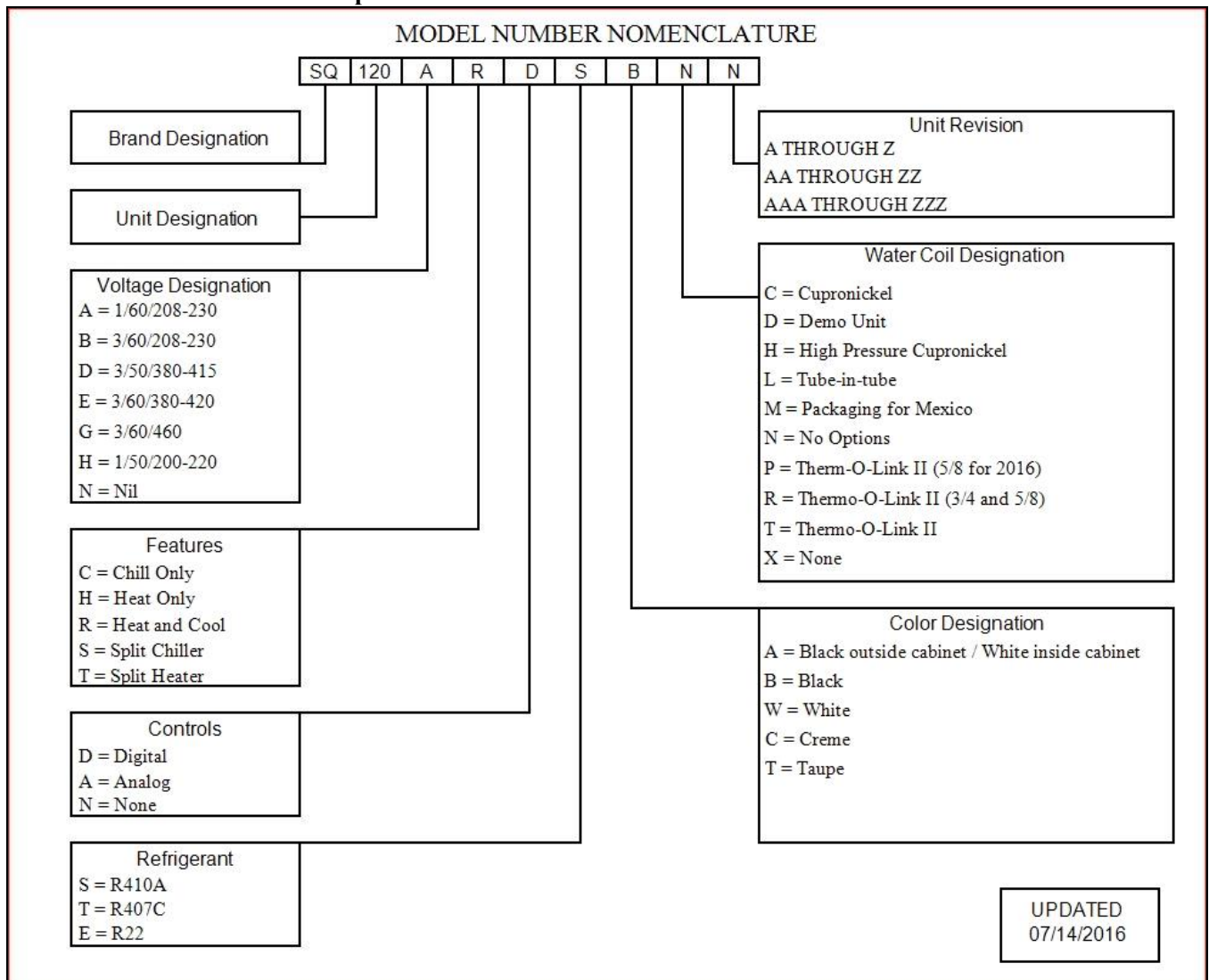

6.2 Initial Heating Recommendations

The following recommendations will reduce the amount of time required to heat a pool. **If unsure of equipment heating capability, review equipment data plate.** See "Identifying Model Specifications" on page 21.

1. Confirm heat pump mode has been set to **HEA**.
2. Set thermostat to desired water temperature.
3. Temporarily override the filter pump's time-clock for continuous operation.
 - This will allow the Heat Pump the time required to heat the water at start-up.
 - After the water has reached the desired temperature, the time-clock can be reset to normal operating time-frames.

6.3 Initial Cooling Recommendations

The following recommendations will reduce the amount of time required to cool a pool or cold plunge application. **If unsure of equipment cooling capability, review equipment data plate.** See "Identifying Model Specifications" on page 21.

1. Confirm heat pump mode has been set to **COO**.
2. Set thermostat to desired water temperature.
3. Temporarily override the filter pump's time-clock for continuous operation.
 - This will allow the Heat Pump the time required to cool the water at start-up.
 - After the water has reached the desired temperature, the time-clock can be reset to normal operating time-frames.

6.4 Available Accessories

5 lb Bypass Valve Kit (Kit STK0135)

- When high flow rates are outside recommended tolerances, please use this kit or an alternative bypass valve system.
- This kit can be used to control excessive water flow through the heat pump. It provides automatic flow adjustments for most applications.

Automatic Sequencing Controller

- An Automatic Sequencing Controller (ASC) provides easy control of all units from one lead unit and prevents the simultaneous start-up of multiple heat pumps.
- Site voltage drop is minimized and utilities are not subjected to large in-rush demands of electrical current.
- Part number is based on number of heat pump's to be controlled. Call AquaCal® Customer Support for assistance with correct configuration.

External Flow Relay (Grid Flow) Switch Kit (0040s)

- Used when the pool / spa elevation is higher than the heat pump.
- Used when a variable two-speed filter pump set on low-speed mode does not provide enough water pressure to activate a heat pump's water pressure switch.
- Also used for automatic pool / spa thermostat switching.

PLEASE NOTE -

The 0040s is not to be used on applications exceeding 50 PSI.

Liquid Blankets

- An invisible liquid heat barrier designed to retain heat and extend the swimming season.
- AquaCal® recommends the Aqua Blanket™.



Plumbing Unions:

SIZE	PART NUMBER
2 INCH	2627

Remote Control Kit (STK0070)

- A remote (wired) control kit allows for full control of the heat pump from up to 100 feet from the equipment.