

FLOW STAR® SKIMMER WITH 5" DEEP THROAT, FLOAT ASSEMBLY, BASKET, LID, ADJUSTABLE COLLAR FOR FIBERGLASS



Built in conformance with NSF 50 and SPS 3 standards



FEATURES

- Adjustable collar
- New weir clip lock secures the clips in the weir door
- Large self-contained basket with lock-in feature (will not float)
- Pre-installed O-ring for float assembly
- Underwater dampers on the faceplate for noise reduction on weir plate – especially on windy days
- Super strong engineered polymer upper housing
- Extra heavy-duty PVC lower unit (does not require transitional glue)
- 2½" outside slip; 2" inside slip (outside skimmer)
- 2" threads for pressure testing (inside skimmer)
- Built-in overflow or fill line knock-out
- Upper housing has pre-cut rebar cutouts with pre-drilled holes for tie wire
- Additional box inside skimmer box for a basket, float assembly and weir plate (so assembly does not get lost on job site)
- Skimmer Lid and Collar G154 UV tested
- Approved for residential use up to 100 GPM
- See page 212 for code compliance and sizing
- Optional custom name/logo engraved on the lid (requires minimum 500 piece lid order)
- Designed to work with all existing fiberglass pool walls
- 1 per case

Three lid options available (sold separately):
round, square or snap-in round/square



Optional vacuum plate with snap-in lug can be glued in under lid for easy storage p/n SK43101



Optional BFB adapter converts skimmer fittings to 4" or 3" tee for improved hydraulics and code compliance p/n BFB101

Part # SKRFL12xxx

STANDARD COLORS

- SKRFL12101 – White
- SKRFL12102 – Black
- SKRFL12103 – Light Gray
- SKRFL12104 – Blue
- SKRFL12105 – Dark Gray
- SKRFL12108 – Tan

Also available without float assembly remove "FL" from part numbers

Snap-in Round/Square Lid and Collar (sold separately) p/n SK65xxx

Square Lid and Collar (sold separately) p/n SK64xxx

Also available without lid/collar (white only) p/n SKRFL12NL101

SPS 3 & NSF 50 Compliant

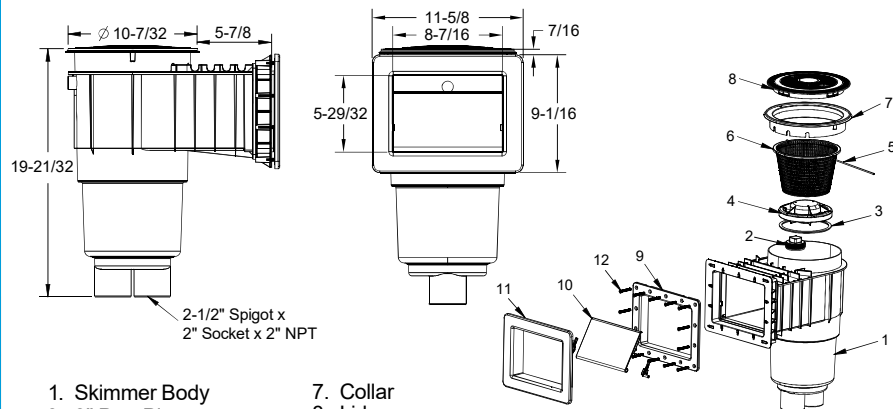

- | | |
|-----------------------|--|
| 1. Skimmer Body | 7. Collar |
| 2. 2" Port Plug | 8. Lid |
| 3. O-Ring | 9. Gasket |
| 4. Float Assembly | 10. Weir Assembly |
| 5. Skimmer Basket Rod | 11. Cover |
| 6. Basket | 12. 12 x 1-3/4" Flat Head Phillips
316 SS, Qty 14 |

ADDITIONAL PRODUCT CONFIGURATIONS FOR SKRFL12XXX

9" Ultra Basket

Available 2" Socket Dual-Port, 4" Socket, 6" Socket, and Water Bonded.

Example: SKRFL12B101D-L= White Water Bonded Flow Star® Skimmer with 4" Socket Sump and 9" Ultra Basket

1 per case

STANDARD COLORS

- SKRFL12101-L – White
- SKRFL12102-L – Black
- SKRFL12103-L – Light Gray
- SKRFL12104-L – Blue
- SKRFL12105-L – Dark Gray
- SKRFL12108-L – Tan

NEW



Part #
SKRFL12xxx-L

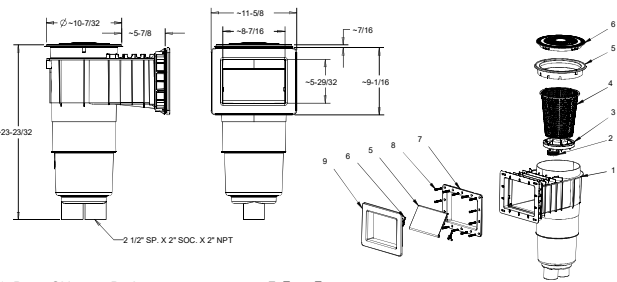

- | | |
|----------------------------|--|
| 1. Deep Skimmer Body | 7. Face Frame |
| 2. 2" NPT Port Plug | 8. #12 x 1-3/4, Flat Head Phillips, 316 SS |
| 3. Float Assembly | 9. Weir Door Assembly |
| 4. 9" Ultra Skimmer Basket | 10. Weir Door Clips |
| 5. Skimmer Collar | 11. Skimmer Collar |
| 6. Skimmer Lid | 12. Decorative Cover |

Water Bonded

Bonding plate and copper wire connection meet NEC section 680.2 C.

Conforms to UL 1081, UL 1563, CAN/CSA-C22.2

Bonding plate is safely placed behind the skimmer basket, for constant water contact, even when the pump is off

1 per case

STANDARD COLORS

- 101
- 103
- 105
- 102
- 104
- 108

NEW

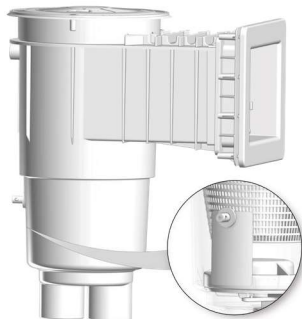

Standard 9" Ultra Basket
Part # SKRFL12Bxxx Part # SKRFL12Bxxx-L

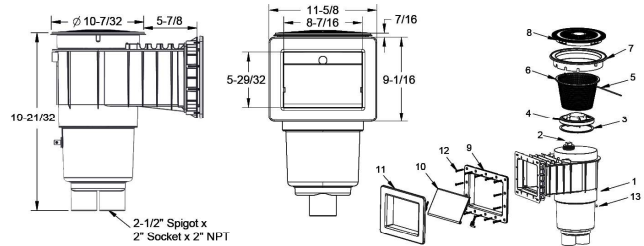

- | | |
|-----------------------|--|
| 1. Skimmer Body | 9. Gasket |
| 2. 2" Port Plug | 10. Weir Assembly |
| 3. O-Ring | 11. Cover |
| 4. Float Assembly | 12. 12 x 1-3/4" Flat Head Phillips
316 SS, Qty 14 |
| 5. Skimmer Basket Rod | 13. Bonding Plate Assembly |
| 6. Basket | |
| 7. Collar | |
| 8. Lid | |

ADDITIONAL PORT CONFIGURATIONS FOR SKRFL12xxx, SKRFL12xxx-L, SKRFL12Bxxx, and SKRFL12Bxxx-L

4" Socket Sump

Extra heavy duty PVC lower unit (no transitional glue required)

Standard
Part #SKRFL12xxxD

9" Ultra Basket
Part # SKRFL12xxxD-L

Water Bonded
Part # SKRFL12BxxxD

Bonded 9" Ultra Basket
Part # SKRFL12BxxxD-L

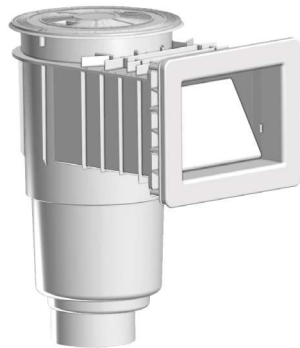

1 per case

6" Socket Sump

Extra heavy duty PVC lower unit (no transitional glue required)

Standard
Part #SKRFL12xxxF

9" Ultra Basket
Part # SKRFL12xxxF-L







Water Bonded
Part # SKRFL12BxxxF

Bonded 9" Ultra Basket
Part # SKRFL12BxxxF-L



1 per case

SKIMMER OPTIONS AND ACCESSORIES

STANDARD COLORS  101  102  103  104  105  108

Adaptor Bushing



Eliminates the need to reduce down 4" or 3" plumbing when connecting to a skimmer with a dual-port PVC sump

Converts two 2½" spigot to 4" or 3" T

Includes two 4" x 3" reducer bushings

Shown as an example only – parts are sold separately

Part # SKR1xx with BFB101

1/case

Skimmer Basket



Polypropylene basket locks in to remain in place during on and off pump cycles

Fits all standard skimmers

Part # SK6

50/case

9" Ultra Skimmer Basket



9" polypropylene Ultra Basket locks in to remain in place during on and off pump cycles

Fits all 9" Ultra Basket models

Part # SK96

50/case

3" Skimmer Extension Collar



Stack multiple collars to reach desired deck or bond beam height

Fits into AquaStar and most standard round skimmer collars (Sta-Rite/Pentair)

Part # SECxxx

20/case

Float Assembly



Includes O-ring gasket and flow adjustment flap

White only

Part # SKFL101

24/case

Weir Plate Assembly for Standard & Vinyl/Fiberglass Skimmers

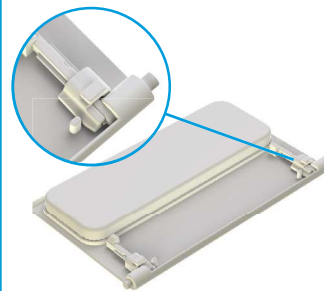

Includes weir clip locks to secure weir clips in place

Also available only weir clips
Part # SK902

Part # SKWDxxx

24/case

SKIMMER OPTIONS AND ACCESSORIES

STANDARD COLORS



101



102



103



104



105



108

Round Skimmer Lid



UV tested to latest standard
Optional custom name/
logo insert p/n RTxxxA
(min 500 pc order)
Fits AquaStar and most
standard round skimmer
collars (Sta-Rite/Pentair)

Part # RTxxx

25/case

Adjustable Round Skimmer Collar



Adjustable collar levels
out uneven surfaces
Fits AquaStar and most
standard skimmers
(Sta-Rite/Pentair)

Part # SK5xxx

20/case

Round Skimmer Lid and Collar



UV tested to latest standard
Optional custom name/logo
insert p/n SKRTxxxA
(min 500 pc order)
Fits AquaStar and most
standard skimmers
(Sta-Rite/Pentair)

Part # SKRTxxx

25/case

Vacuum Plate

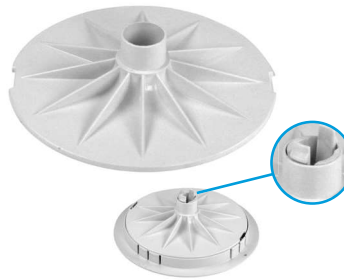

Snaps under skimmer lid
for easy storage
White only

Part # SK43101

25/case

Square Skimmer Lid

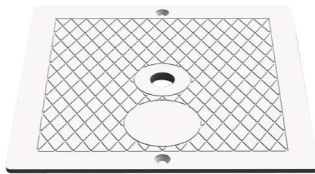

UV tested to latest standard
Optional custom name/
logo insert p/n SK63xxxA
(minimum 500-piece order)
Fits AquaStar and most
standard square skimmer
collars (Sta-Rite/Pentair)

Part # SK63xxx

24/case

Square Skimmer Collar



Adjustable collar levels
out uneven surfaces
Fits AquaStar and most
standard skimmers
(Sta-Rite/Pentair)

Part # SK61xxx

6/case

Square Skimmer Lid and Collar



UV tested to latest standard
features
Optional custom name/
logo insert p/n SK64xxxA
(minimum 500-piece order)
Fits AquaStar and most
standard skimmers
(Sta-Rite/Pentair)

Part # SK64xxx

6/case

Round/Square Snap-in Lid and Collar



Round lid snaps into square
housing
UV tested to latest standard
Optional custom name/
logo insert p/n SK65xxxA
(minimum 500-piece order)
Fits AquaStar and most
standard skimmers
(Sta-Rite/Pentair)

Part # SK65xxx

8/case