



MOUNTING BASE FOR ABOVEGROUND PUMP & FILTER SYSTEMS

INSTALLATION INSTRUCTIONS

Kit Contents

- AG systems mounting base (“the system base”)
- Lag screws, #20 x 1-1/4” long
- Lag screws, #20 x 2-1/2” long

Tools needed

Flathead regular screwdriver
½” wrench or socket

 **WARNING** — Always disconnect power to the pool pump at the circuit breaker before servicing the pump. Failure to do so could result in death or serious injury to serviceman, pool users or others due to electric shock.

 **WARNING** — DO NOT open the strainer pot if pump fails to prime or if pump has been operating without water in the strainer pot. Pumps operated in these circumstances may experience a build up of vapor pressure and may contain scalding hot water. Opening the pump may cause serious personal injury. In order to avoid the possibility of personal injury, make sure the suction and discharge valves are open and strainer pot temperature is cool to touch, then open with extreme caution.

Read all servicing instructions before working on the pump.

Technical support

Sanford, North Carolina (8 A.M. to 5 P.M. - ET)

Moorpark, California (8 A.M. to 5 P.M. – PT)

Phone: (800) 831-7133

Fax: (800) 284-4151

Web sites: www.pentairpool.com – www.staritepool.com

P/N 710042 Rev. B 5/6/13

Introduction

The Pentair Aquatic Systems Mounting Base for the Aboveground Systems for Pool and Filter Systems installation kit contains everything you need to configure and position the mounting base. Position the aboveground pool pump/filter system on a level area intended for use as the equipment pad for the pool.

Installation

⚠ WARNING! Risk of electrical shock or electrocution.

1. Be sure all electrical breakers and switches to the pump are switched OFF, and disconnect the communication cable from the pump before installing the base.

Seat the pump

1. Orient the pump so the pump strainer pot faces in the direction of the arrow (see Figure 1).

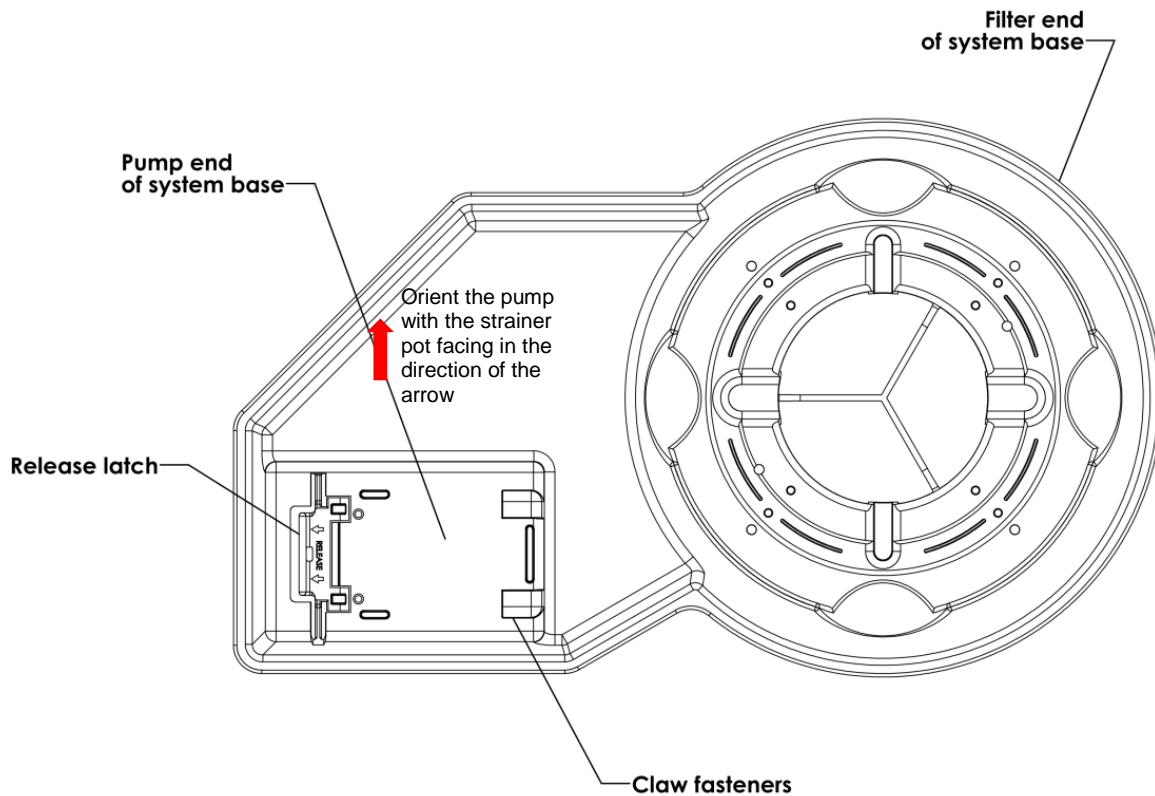

Figure 1

2. Slide the pump foot between the claw fasteners and the release latch. See Figure 2. Seat the pump by pushing down on it until the release latch clicks into place on the pump foot (see Figure 3).



Figure 2

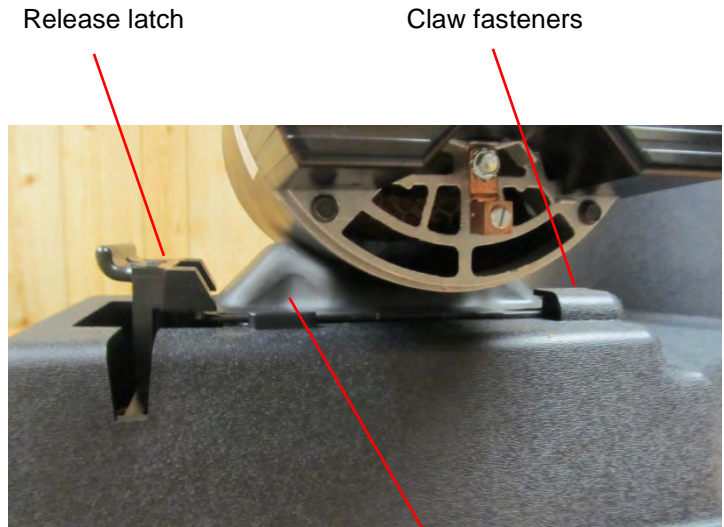

Figure 3

Seat the filter tank foot

1. Place the filter tank foot on the filter end of the system base (see Figure 4).



Figure 4

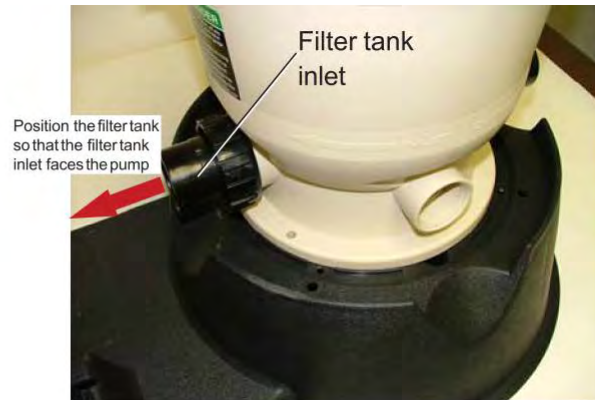

Figure 5

2. Position the filter tank foot so that the filter tank inlet faces the pump end of the system base (see Figure 5).

Secure the filter tank foot

The system base provides screw holes to align with the screw holes* in the foot of the filter tank. The system base supports the following filter models: PLM, PLD, PXC, PRC, PRD, Clean & Clear®, Warrior®, EasyClean™ filters (see Figure 6).

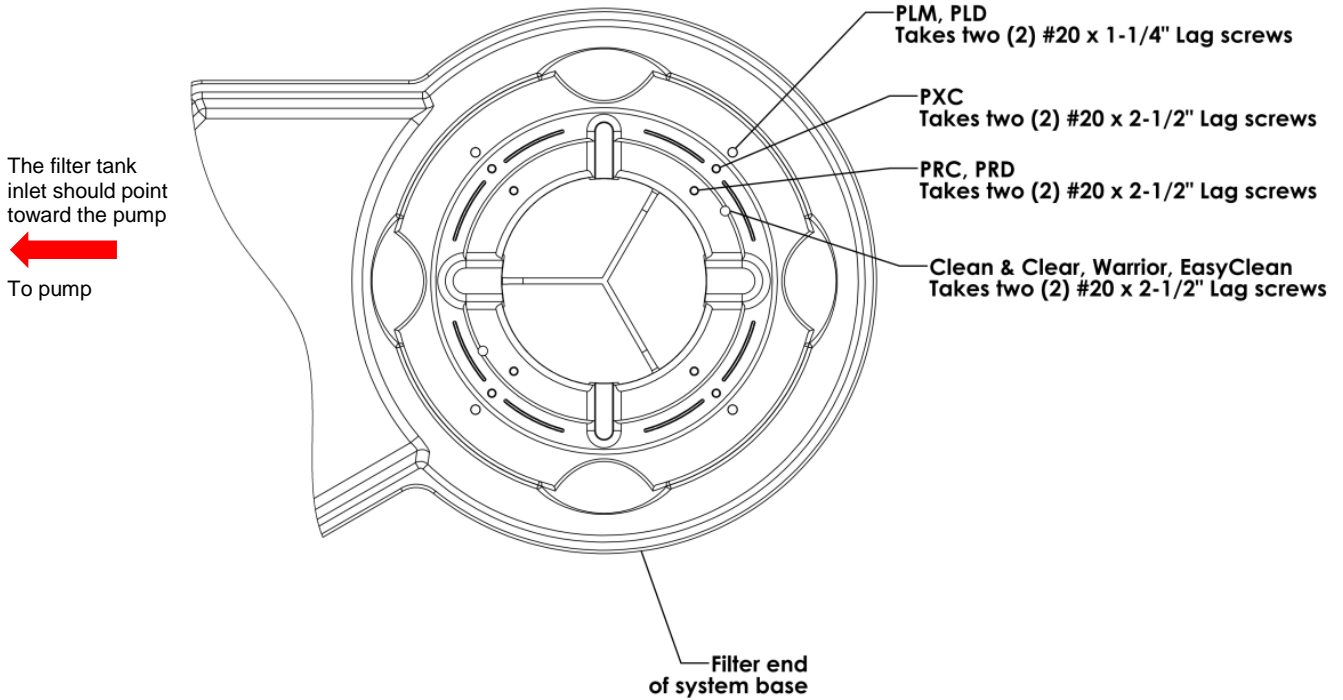

Figure 6

Note: (*) Filter tanks for sand systems neither use nor require screw holes.

1. With the filter tank inlet aligned toward the pump, identify which screw holes in the system base align with the screw holes in the tank foot (see Figure 7).

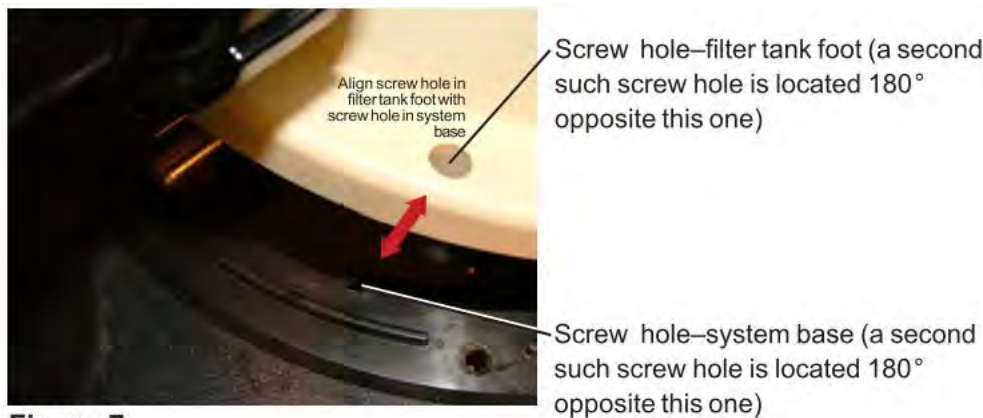

Figure 7

Secure the filter tank foot (continued)

- Refer to Figure 6 on the previous page, and to the table below to determine the correct screw for the hole pattern. **Note:** Each filter model will use *either* the #20 x 1-1/4" long or 2-1/2" long Lag screws, never both.

<u>Filter model</u>	<u>Screw</u>
PLM, PLD	#20 x 1-1/4" Lag screws
PXC	#20 x 2-1/2" Lag screws
PRC, PRD	#20 x 2-1/2" Lag screws
Clean & Clear®, Warrior®, EasyClean™ Filter	#20 x 2-1/2" lag screws

- Install a screw through one of the screw holes in the tank foot into the system base (see Figure 8). Do not fully tighten the screw into the base at this time. Repeat with the other hole located 180° opposite the first one.

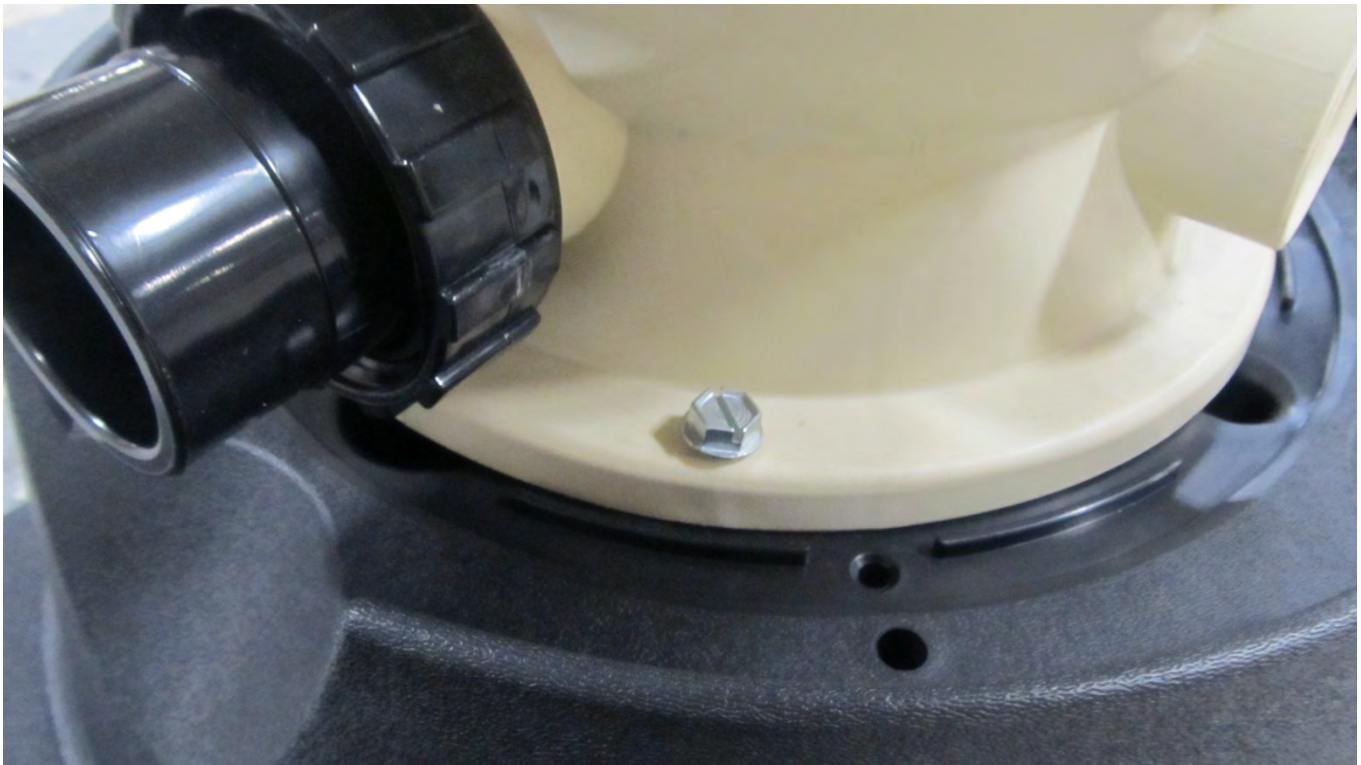

Figure 8

Secure the pump

1. Complete the pump/filter connection by connecting the plumbing between the pump volute and the filter inlet.
2. Secure the pump foot to the system base by inserting two (2) #20 x 1-1/4 long Lag screws through the slots in the pump foot into the corresponding holes in the system base next to the release latch (See Figure 9). Do not fully tighten the screw into the base at this time.

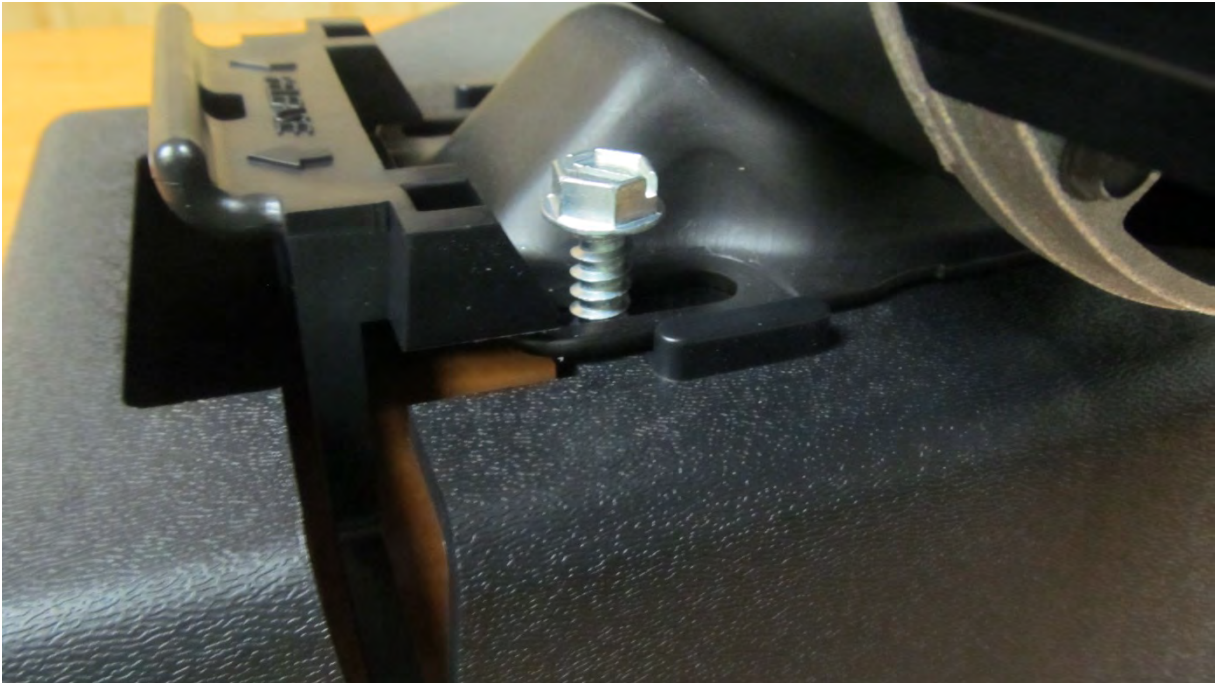

Figure 9

3. Ensure all plumbing connections are tight. Fully tighten all Lag screws to hold filter and pump firmly in place.

Removal



WARNING! Risk of electrical shock or electrocution.

1. Make sure all electrical breakers and switches to the pump are turned off, and disconnect the communication cable from the pump before removing from the system base.

Remove the pump

1. Disconnect the pump/filter connection.
2. Remove the two (2) Lag screws that hold down the pump to the base.
3. Press the release latch and pull upward on the rear of the pump motor assembly.
4. Lift the pump off the system base.



1620 HAWKINS AVE., SANFORD, NC 27330 • [919] 566-8000
10951 WEST LOS ANGELES AVE., MOORPARK, CA 93021 • [805] 553-5000
WWW.PENTAIRPOOL.COM

All Pentair trademarks and logos are owned by Pentair, Inc. Pentair Aquatic Systems™, PLM™, PLD™, PXC™, PRC™, PRD™, Clean & Clear®, Warrior®, and EasyClean™ are trademarks or registered trademarks of Pentair Water Pool and Spa, Inc. and/or its affiliated companies in the United States and/or other countries. Unless expressly noted, names and brands of third parties that may be used in this document are not used to indicate an affiliation or endorsement between the owners of these names and brands and Pentair Water Pool and Spa, Inc. Those name and brand may be the trademarks or registered trademarks of those third parties. Because we are continuously improving our products and services, Pentair reserves the right to change specifications without prior notice. Pentair is an equal opportunity employer.

© 2013 Pentair Aquatic Systems. All rights reserved. This document is subject to change without notice.



P/N 710042 Rev. B 5/6/13