

### FEATURES

Provides easy installation and hassle-free connect and disconnect

Self-sealing – no Teflon<sup>®</sup> tape needed

2" MIP x 2" socket







Removes stress on mating part

50 per case



Part # UNHT20

### STANDARD COLORS

	101		104
	102		105
	103		108

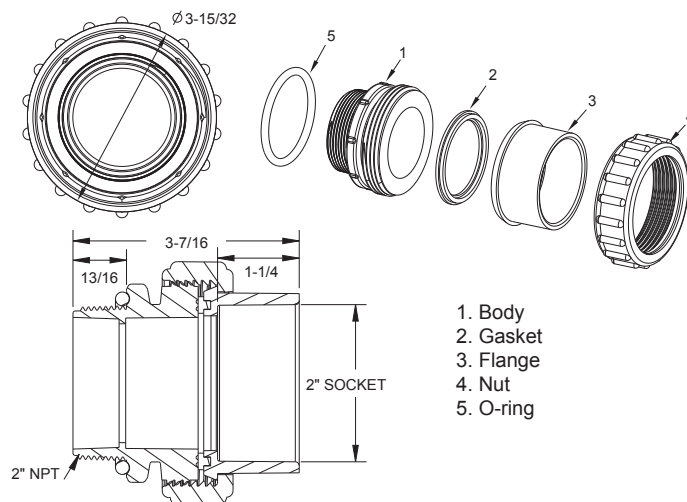

1. Body
2. Gasket
3. Flange
4. Nut
5. O-ring