



Montego Fire Pit Table

Installation Instructions for Montego Fire Pit Models
MG-1242-BLSM-K and MG-1242-BLK-K



IMPORTANT

Please consult your Crystal Fire instruction manual for detailed instructions and important information related to hooking up your linear burner, including safety information, proper tightening of connections with two wrenches and full burner setup and lighting instructions.

DO NOT ATTEMPT TO INSTALL CF-1242 BURNER WITHOUT FIRST CONSULTING THE CRYSTAL FIRE OWNER'S MANUAL.

Contents

Required Tools.....	2
Included with your Fire Pit.....	3
Assembly Instructions.....	4
Gas Connections.....	7
Igniter Installation.....	9
Glass Installation.....	10
Position Your Tank.....	11

Required Tools



- **Utility Knife**

To cut and remove packaging



- **2 Open Ended Wrenches**

To secure gas connections



- **Leather Gloves**

To protect hands from glass and sharp edges during install



- **One AAA Battery (not included)**

Required for electric spark igniter installation



- **Two people are required for this installation**

Included with your Fire Pit



M6 Allen Wrench [X 1]



Bolt Caps [X 4]



Touch-up Paint [X 1]

Gas Valve Kit

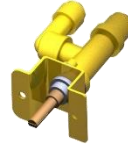

Gas Valve (x1)



Mounting screws (x2)

Bolt A [X 4]

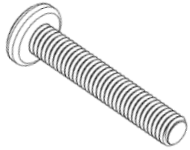

M6X35

Bolt B [X 4]



M6X20

Bolt C [X 4]



M6X16



Control knob (x1)



Clear Silicone Pads [X 6]

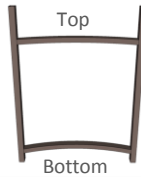

Center Support [X 1]



Panel A [X 1]



Panel B [X 1]



Panel C [X 1]



Access Door [X 1]



Glass Top

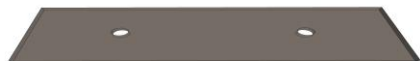

Glass Cover

Assembly Instructions

1. Unpack the fire pit table contents from the box, and remove individual packaging from each piece.
2. Lay Panel A on soft, flat surface.
3. Position Center Support on Panel A.

NOTE: it is very important to place the Center Support exactly as shown in the picture below. This will ensure that your burner (and propane tank, if applicable) will fit correctly with your fire pit table base. (Refer to “Included with Your Fire Pit” for component details).

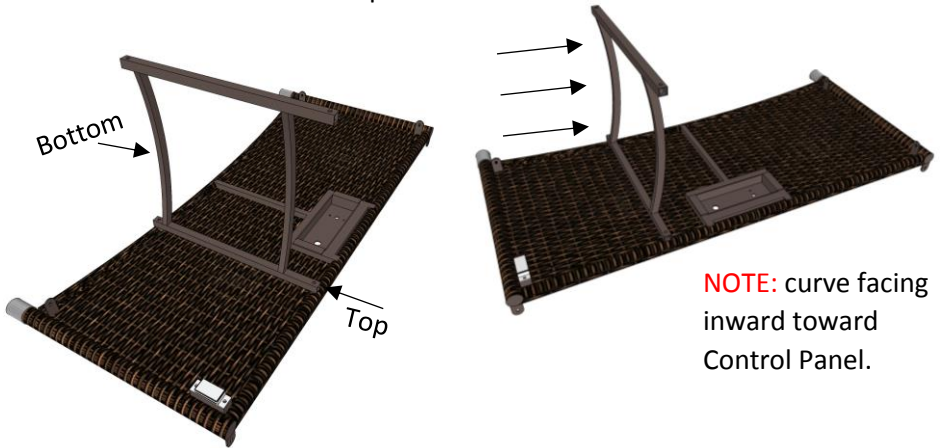

4. Attach Center Support with Bolt A (x2).

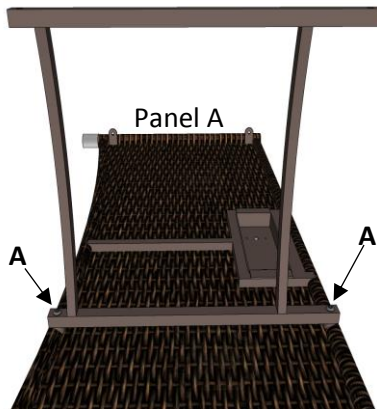

4. Stand up Panel A and use 2 more Bolt A to attach Center Support to Panel B.

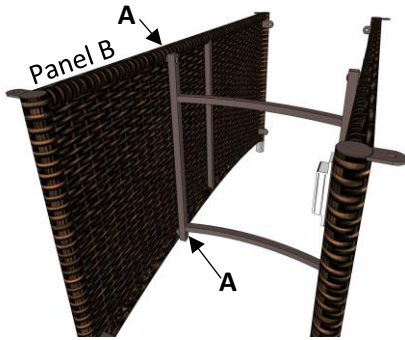

5. Use Bolt B (x4) to attach Panel C as shown.

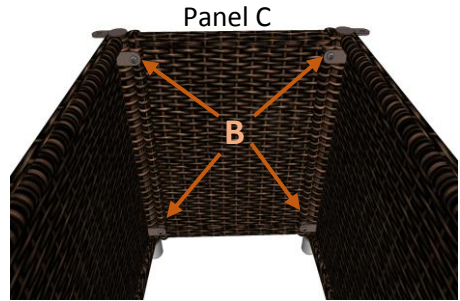

6. Remove the 4 pre-installed bolts (Bolt C) from the underside of the Glass Top, set the top into place on the base, and reinstall the bolts to fasten the top to the base.

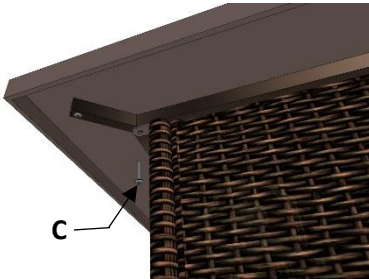

Optional: Attach Bolt Caps to Bolt C if you desire. Simply press on.

7. Once the Glass Top is in place, attach the Access Door to the fire pit table base. Set mounting pins at bottom of Access Door into the mounting holes located on side panels as shown below.

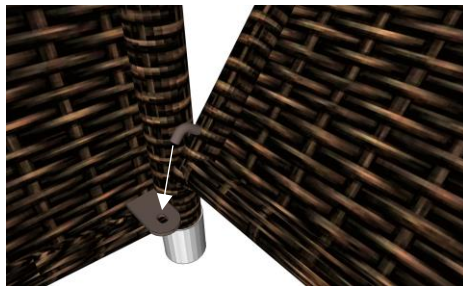

8. Hold the Gas Valve in place from behind the control panel as shown while inserting the two included screws. Use a Philips screwdriver to fasten. Attach control knob by pressing on to the valve stem.

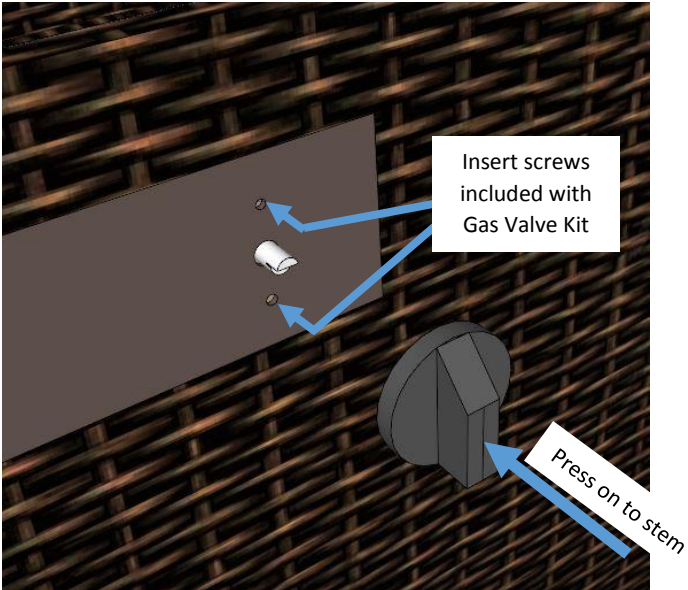
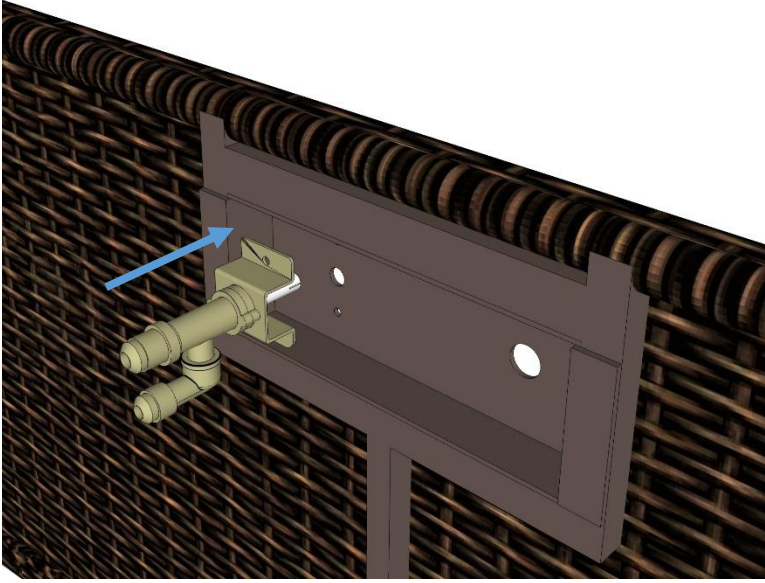

Gas Connections

Read and understand your Crystal Fire owner's manual before beginning burner hookups or using the device.

Do not use Teflon tape or pipe dope on flare fittings.

1. Reach inside the burner cut-out and attach natural gas supply line using a 3/8" flare fitting, or attach the included black rubber propane hose and regulator to the bottom fitting of the control valve.

TIGHTEN SECURELY WITH A WRENCH

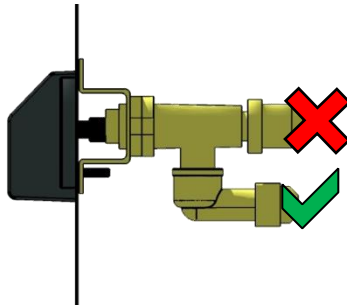

- Propane input
- Natural gas input



OR

Natural gas supply line
as specified by local
building codes

2. Lay the burner upside down on a flat, soft surface to avoid scratching the polished metal. Ensure the correct orifice is installed for the fuel type you are using (see Crystal Fire user manual included with burner for orifice sizing information)
Attach the included metal flex hose to the burner.

TIGHTEN SECURELY WITH TWO WRENCHES

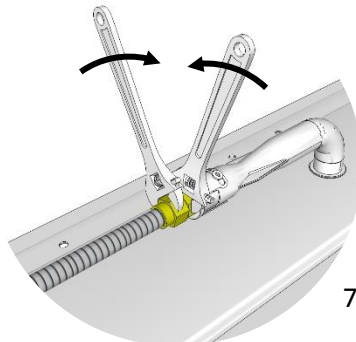
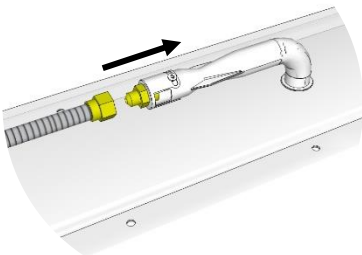

3. Set Burner into the fire pit base exactly as shown and make final gas connection to the Control Panel.

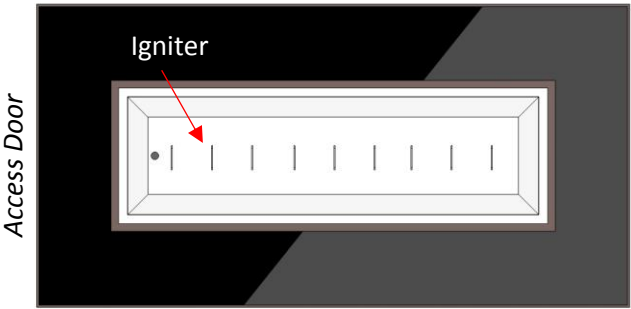

TIGHTEN CONNECTION
SECURELY WITH WRENCH

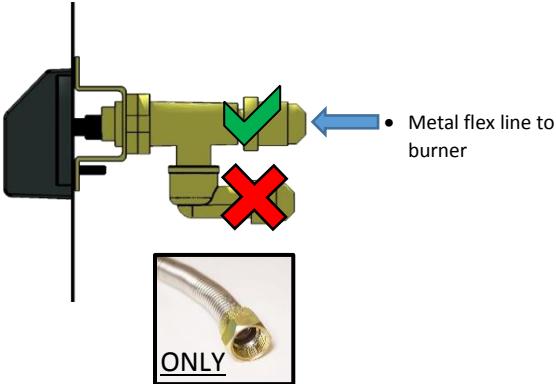

Igniter Installation

1. Make sure the valve is in the OFF position before beginning.
2. Install sparker as shown, using a AAA battery (not included). Negative end should be placed inside the CF-SPARKER, positive end outside of the CF-SPARKER.

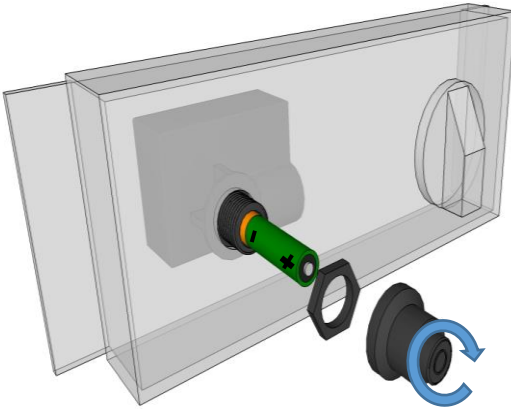

Sparker will not operate correctly without an ignition **and** ground wire attached.

- Plug both **BLACK** wires hanging from the burner into the back of the sparker box.

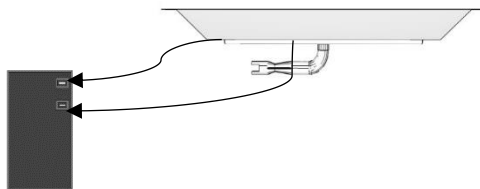

- Test system by pushing the button on the igniter. Consult the troubleshooting section of the Crystal Fire Owner's Manual, if the spark is weak, intermittent, or not present.

Glass Installation

1. Scatter all of the included Glass Beads evenly onto burner surface.

DO NOT OPERATE CRYSTAL FIRE BURNER WITHOUT GLASS BEADS OR OTHER DECORATIVE MEDIA PRESENT

2. Place a single Silicone Pad in each corner and two in the center as shown below.

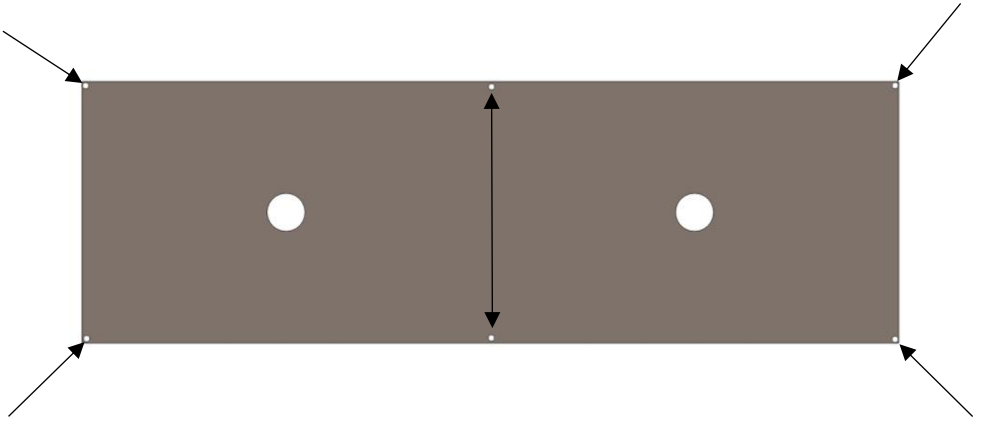

3. Set the cover into place on top of the burner with silicone pads facing down.

DO NOT OPERATE CRYSTAL FIRE BURNER WITH GLASS COVER IN PLACE



After installing igniter and making gas connections, verify that all connections are tight and that no leaks are present using a solution of soapy water or a commercially available leak-check solution.

Position Your Tank (if applicable)



1. Remove door, connect the propane hose/regulator to the propane tank and hand tighten (DO NOT USE A WRENCH) and slide the propane tank past the dotted line to ensure the door closes properly.
2. With the tank inside, ensure that no hoses, wires, or any other components are kinked or touching the burner pan.

IMPORTANT

Please consult your Crystal Fire instruction manual for detailed instructions and important information related to hooking up your linear burner, including safety information, proper tightening of connections with two wrenches and full burner setup and lighting instructions.

DO NOT ATTEMPT TO INSTALL CF-1242 BURNER WITHOUT FIRST CONSULTING THE CRYSTAL FIRE OWNER'S MANUAL.

WARNING

After consulting the manual and following instructions, remember; before operating, all gas connections must be fully checked for leaks

Warranty: Fire pit tables are covered under a 1-year manufacturer's warranty. Please visit <http://www.outdoorrooms.com/warranty-form/> to register your product.