



# The Vintage Fire Pit Table

Installation Instructions for Vintage Fire Pit Table

VNG-2424BRN





# IMPORTANT





Please consult your Crystal Fire instruction manual for detailed instructions and important information related to burner installation, including safety information, proper tightening of connections with two wrenches, and full burner setup and lighting instructions.

**DO NOT ATTEMPT TO INSTALL CF-2424 BURNER WITHOUT FIRST CONSULTING THE CRYSTAL FIRE OWNER’S MANUAL.**

## Contents

Required Tools.....	3
Included with your Fire Pit.....	4
Assembly Instructions.....	5
Gas Connections.....	6
Igniter Installation.....	8
Glass Installation.....	10

## Required Tools

-  • **Two people are required for this installation**
-  • **2 Open Ended Wrenches**  
To secure gas connections
-  • **Leather Gloves**  
To protect hands from rough edges found on fire pit during installation
-  • **One AAA Battery (not included)**  
Required for electric spark igniter installation
-  • **Utility Knife**  
To cut and remove packaging

# Included with your Fire Pit

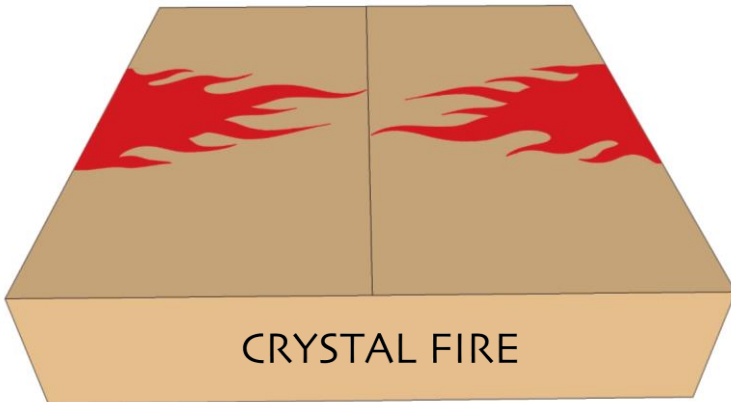

**CF-2424 Square Burner**

# Assembly Instructions

1. Open packaging and remove the access door before removing the fire pit base from the box.

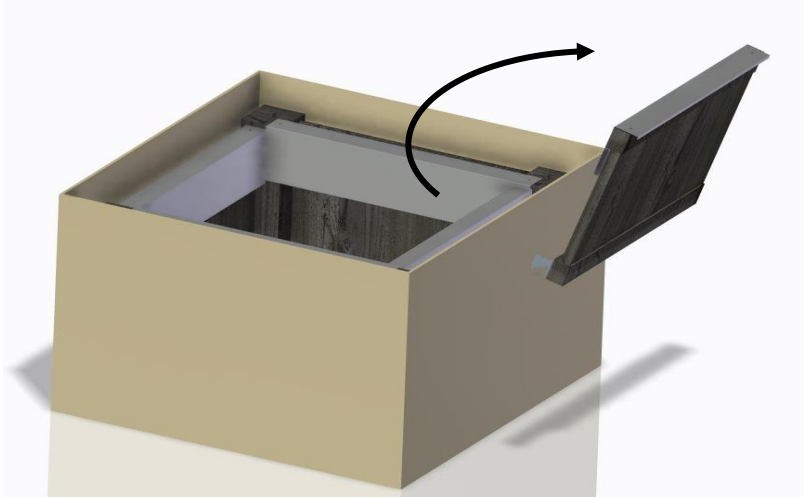

2. Set the base in the desired location and set top onto base. Ensure top is aligned with the wood dowels, found in each corner. Replace access door.

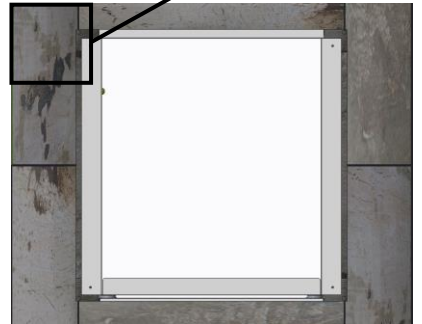
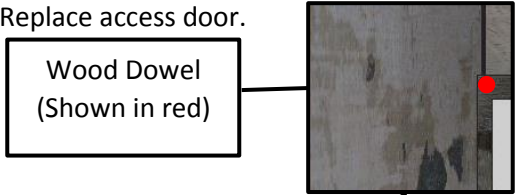
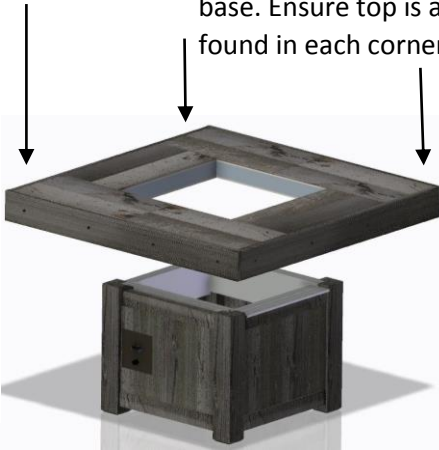

# Gas Connections

**Read and understand your Crystal Fire owner's manual before beginning burner hookups or using the device.**

**Do not use Teflon tape or pipe dope on flare fittings.**

1. Reach inside the burner cut-out and attach natural gas supply line using a 3/8" flare fitting, or attach the included black rubber propane hose and regulator to the bottom fitting of the control valve.

## **TIGHTEN SECURELY WITH A WRENCH**

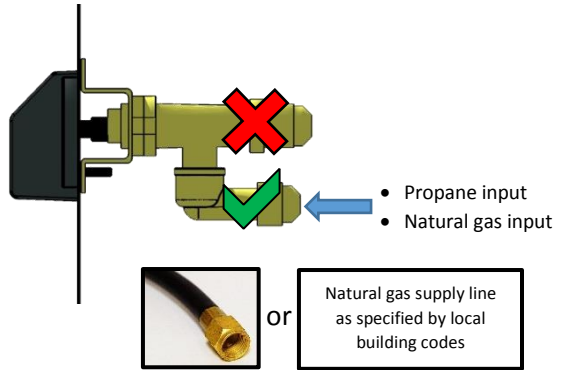
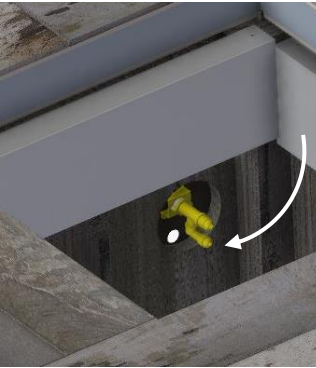

2. Lay the burner upside down on a flat, soft surface to avoid scratching the polished metal. Ensure the correct orifice is installed for the fuel type you are using (see Crystal Fire user manual included with burner for orifice sizing information) Attach the included metal flex hose to the burner.

## **TIGHTEN SECURELY WITH TWO WRENCHES**



3. Set the burner into the fire pit table exactly as shown and make final gas connection to the control panel.

**Sparker**

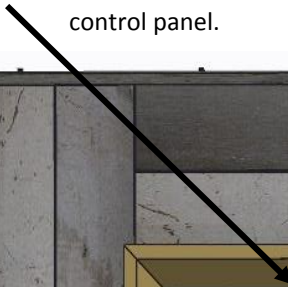

**Access Door**  
→

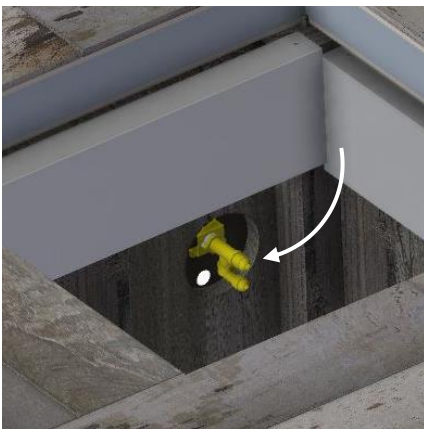

**TIGHTEN CONNECTION  
SECURELY WITH WRENCH**

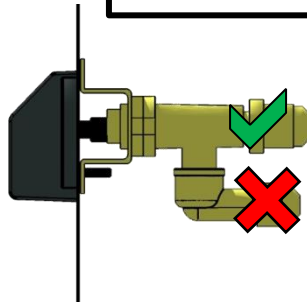

• Metal flex line to burner



# Igniter Installation

1. Make sure the valve is in the OFF position before beginning.
2. Install sparker as shown, using an AAA battery (not included).

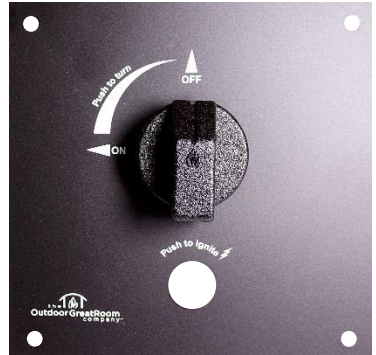
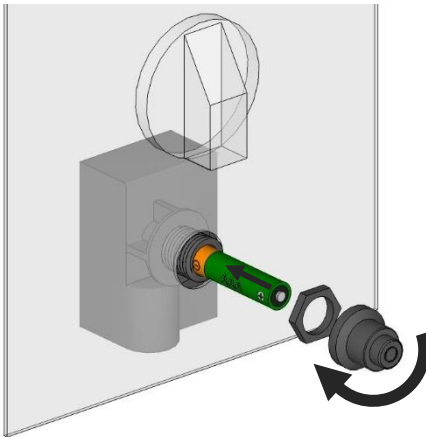

Sparker will not operate correctly without an ignition **and** ground wire attached.

- Plug both **BLACK** wires hanging from the burner into the back of the sparker box. If an orange wire is present, do not use it. Orange wire is for automatic ignition system add-on only.

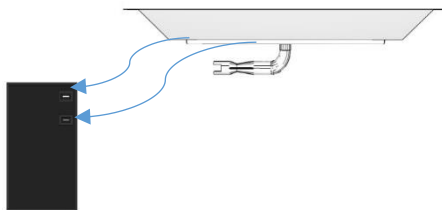

- Test system by pushing the button on the igniter. Consult the troubleshooting section if spark is weak, intermittent, or not present.



After installing igniter and making gas connections, verify that they are tight and that no leaks are present using a solution of soapy water or a commercially available leak-check solution.

## Position Your Tank (If Applicable)

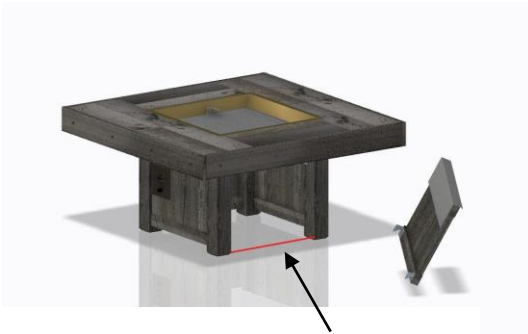

1. Remove door, connect the propane hose/regulator to the propane tank and hand-tighten (DO NOT USE A WRENCH) and slide the propane tank past the solid red line to ensure the door closes properly.
2. With tank inside base, ensure that no hoses, wires, or anything else is kinked or touching the burner pan.

# Glass Installation



1. Scatter all the included glass beads evenly onto burner surface.

**DO NOT OPERATE CRYSTAL FIRE BURNER WITHOUT INCLUDED GLASS BEADS**

## **IMPORTANT**

Please consult your Crystal Fire instruction manual for detailed instructions and important information related to burner installation, including safety information, proper tightening of connections with two wrenches, and full burner setup and lighting instructions.

**DO NOT ATTEMPT TO INSTALL CF-2424 BURNER WITHOUT FIRST CONSULTING THE CRYSTAL FIRE OWNER'S MANUAL.**

## **WARNING**

After consulting the manual and following instructions, remember: before operating, all gas connections must be fully checked for leaks

**Warranty:** Fire pit tables are covered under a 1-year manufacturer's warranty. Please visit <http://www.outdoorrooms.com/warranty-form/> to register your product.

Thank you for purchasing an Outdoor GreatRoom Company product! This fire pit was made with pride in the USA.



14400 Southcross Drive West • Suite 100 • Burnsville, MN 55306  
Toll Free: 1-866-303-4028 • [Sales@OutdoorRooms.com](mailto:Sales@OutdoorRooms.com)