



TechBook

in.k1000

full-featured color capacitive
touchscreen display keypad for spas



Fun, simple, engaging

Truly interactive control

Larger, faster and cooler





Table of contents

Warning	2
Introduction	3
Overview	
- in.k1000 dimensions	4
Installation	
- Installation of in.k1000	5
- Drilling template	6
- Installation notes	8
- Connecting in.k1000 to the spa pack	8
Keypad functions	
- in.k1000 keypad layout	10
- Power	10
- Main screen	10
- Start or stop accessories	11
- Notifications	11
- Water temperature	12
- Spa menu	12
- Display page	12
- Contrast page	13
- Settings	13
- Water care	14
- Modifying schedules	15
- Maintenance	15
- Error Log	15
- Date and time	16
- Keypad settings	17
- Temperature units	17
- Display page	17
- Contrast page	18
- Language Select	18
- Electrical configuration	18
- Wi-Fi	19
- About	19
- Wipe screen	20
- in.stream 2 functions	20
- in.clear functions	21
Error messages	23
Feature matrix	24
Specifications	25



Warning



WARNING:

Before installing or connecting the unit, please read the following.

FAILURE TO COMPLY WITH THE FOLLOWING WARNINGS MAY SIGNIFICANTLY SHORTEN THE PRODUCT'S LIFE TIME, AND LEAD TO FAILURES AS WELL AS HAZARDOUS CONDITIONS*. COMMON SENSE MUST ALWAYS PREVAIL WHEN EVALUATING THE INSTALLATION AND/OR USE OF ANY ELECTRONIC CONTROL IN A FINAL APPLICATION.

- * RESPECT ENVIRONMENTAL CONDITIONS LISTED AT END OF TECHBOOK.
- * THIS UNIT MUST BE INSTALLED BY QUALIFIED PERSONNEL.
- * ONLY QUALIFIED PERSONNEL ARE TO SERVICE THIS UNIT. THERE ARE NO USER SERVICEABLE PARTS INSIDE.
- * THIS UNIT SHOULD BE INSTALLED ON A CLEAN FLAT SURFACE.
- * THE GASKET ON THE BACK OF THE UNIT WILL PREVENT WATER INFILTRATION INSIDE, BEHIND THE MOUNTED SURFACE. IF THE GASKET IS DAMAGED, SEAL THE BACK OF THE UNIT WITH SILICONE TO AVOID ANY LEAKAGE BEHIND THE MOUNTED SURFACE.
- * THIS UNIT MUST BE MOUNTED ON THE OUTSIDE EDGE OF THE SPA. SEE INSTALLATION SECTION FOR DETAILS.
- THE BACK OF THIS UNIT SHOULD NOT BE ENCLOSED IN A WAY THAT CAUSES WATER TO COLLECT. SEE INSTALLATION SECTION FOR DETAILS.
- * HAZARDOUS CONDITION:
A CONDITION THAT IS POTENTIALLY DAMAGING AND/OR DANGEROUS TO THE OPERATOR OR SURROUNDINGS. THIS INCLUDES, BUT IS NOT LIMITED TO: FIRE, FLOODING OR OTHER WATER DAMAGE, DIELECTRIC BREAKDOWNS (PRESENCE OF HIGH VOLTAGE), ETC.

MAINTENANCE

IF YOU HAVE PROBLEMS, DO NOT ATTEMPT TO REPAIR THE UNIT YOURSELF. RETURN IT TO YOUR DEALER OR SERVICE STATION FOR SERVICING.

ACCESSORY PARTS

BE SURE TO USE ONLY THE SPECIFIED ACCESSORY PARTS. USE OF OTHER THAN DESIGNATED PARTS MAY DAMAGE THIS UNIT INTERNALLY OR MAY NOT SECURELY INSTALL THE UNIT IN PLACE. THIS MAY CAUSE PARTS TO BECOME LOOSE RESULTING IN HAZARDS OR PRODUCT FAILURE.

DISPOSAL OF THE PRODUCT

THE APPLIANCE (OR THE PRODUCT) MUST BE DISPOSED OF SEPARATELY IN ACCORDANCE WITH THE LOCAL WASTE DISPOSAL LEGISLATION IN FORCE.



Compatible spa controllers:

in.xm2, in.xe, in.yt, in.yj and in.ye with compatible software revision.

Aeware®, Gecko®, and their respective logos are Registered Trademarks of Gecko Alliance Group. in.k1000™, in.xm2™, in.xe™, in.yt™, in.ye™, in.yj™, in.tune™, in.stream™, in.stream 2, in.mix™, in.clear™, in.touch™ and in.therm™, and their respective logos are trademarks of Gecko Alliance Group.

All other product or company names that may be mentioned in this publication are tradenames, trademarks or registered trademarks of their respective owners.



in.k1000

full-featured color capacitive
touchscreen display keypad for spas

Fun, simple, engaging one level menu interface

Parting ways with physical buttons, keys and overlays, Gecko's in.k1000 touchscreen keypad is fun to use, simple to learn and features an intuitive and engaging one level menu interface.

Truly interactive control of all spa and accessory functions and settings

Mode and function selection wheels, all-on or all-off one touch activation key of last used settings, interactive display icons and on-screen reminders and messages make for a unique user interface. Control and get direct feedback and seamless interaction with your spa equipment and connected value added accessories like in.clear, in.mix and in.stream 2.

Larger, faster, and cooler touch screen display

Driven by a powerful 400 MHz processor, the in.k1000 keypad features an eye-catching 4.3 inch 256K color LCD capacitive touchscreen display resting within a thin and beautiful enclosure that houses its cutting-edge electronics. The in.k1000 keypad fits perfectly on the edge of any spa.



Overview

in.k1000 dimensions

Front view

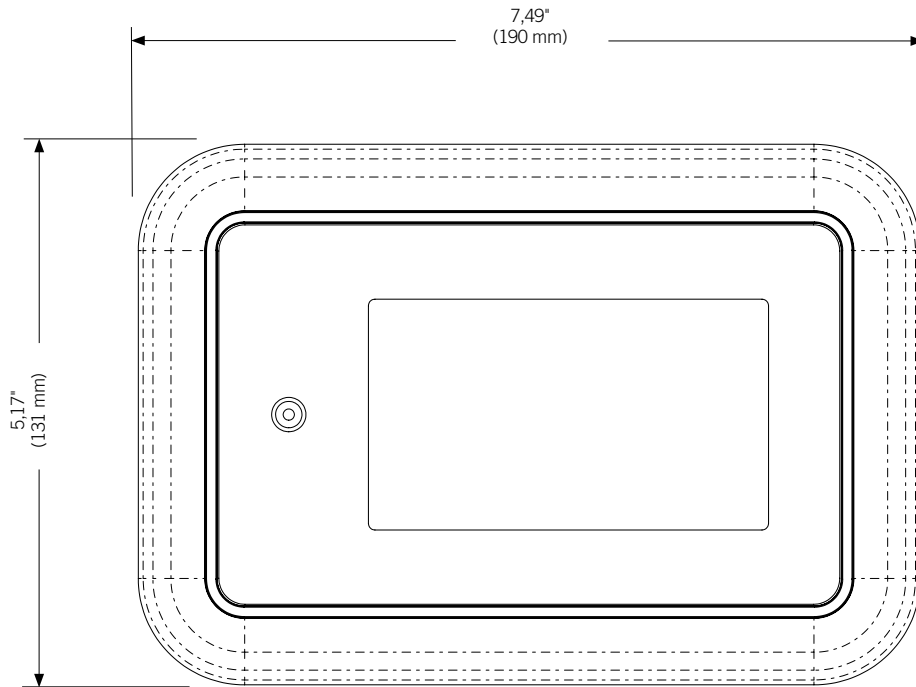

Side view

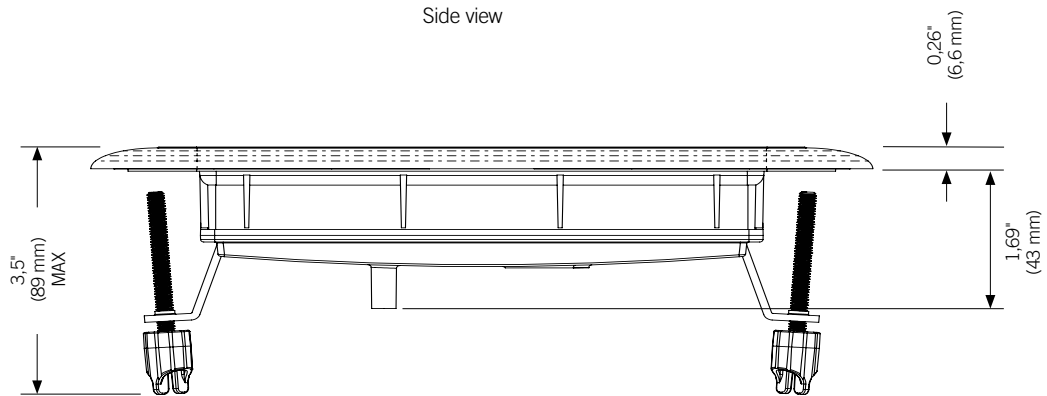

Installation

Installation of in.k1000

When installing the keypad on the spa, a minimum angle of 4 degrees must be respected.

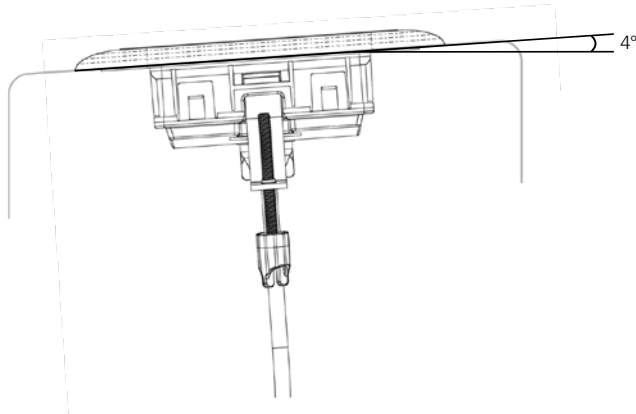

To install the in.k1000, use the drilling template provided in this section.

Determine the mounting location and stick the template on the chosen location.

Cut out an opening according to the template (see illustration).

Clean the installation surface and peel the adhesive gasket from the back of the keypad.

Insert the keypad and align it correctly, then ensure it is properly glued by gently pressing evenly on the entire surface.

Gasket with or without adhesive

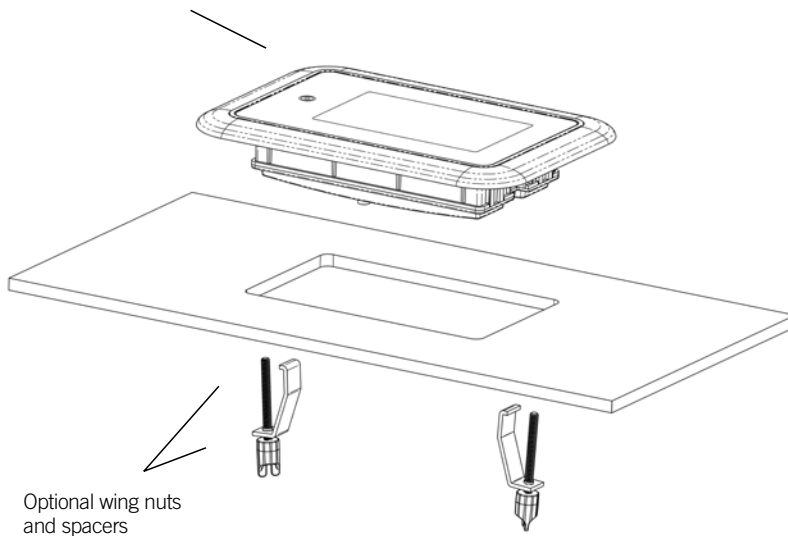

Optional wing nuts and spacers



Installation

Drilling template

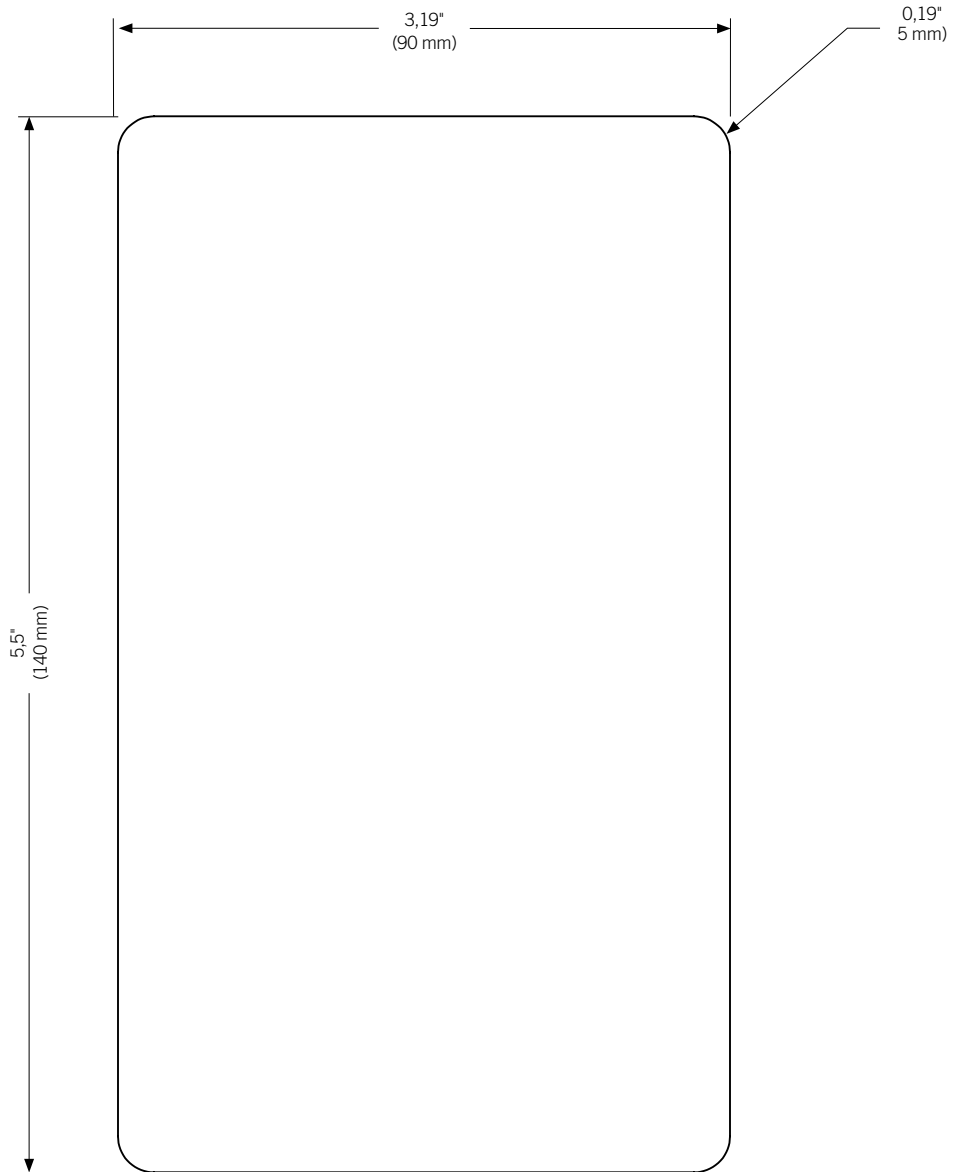



Installation

Drilling template

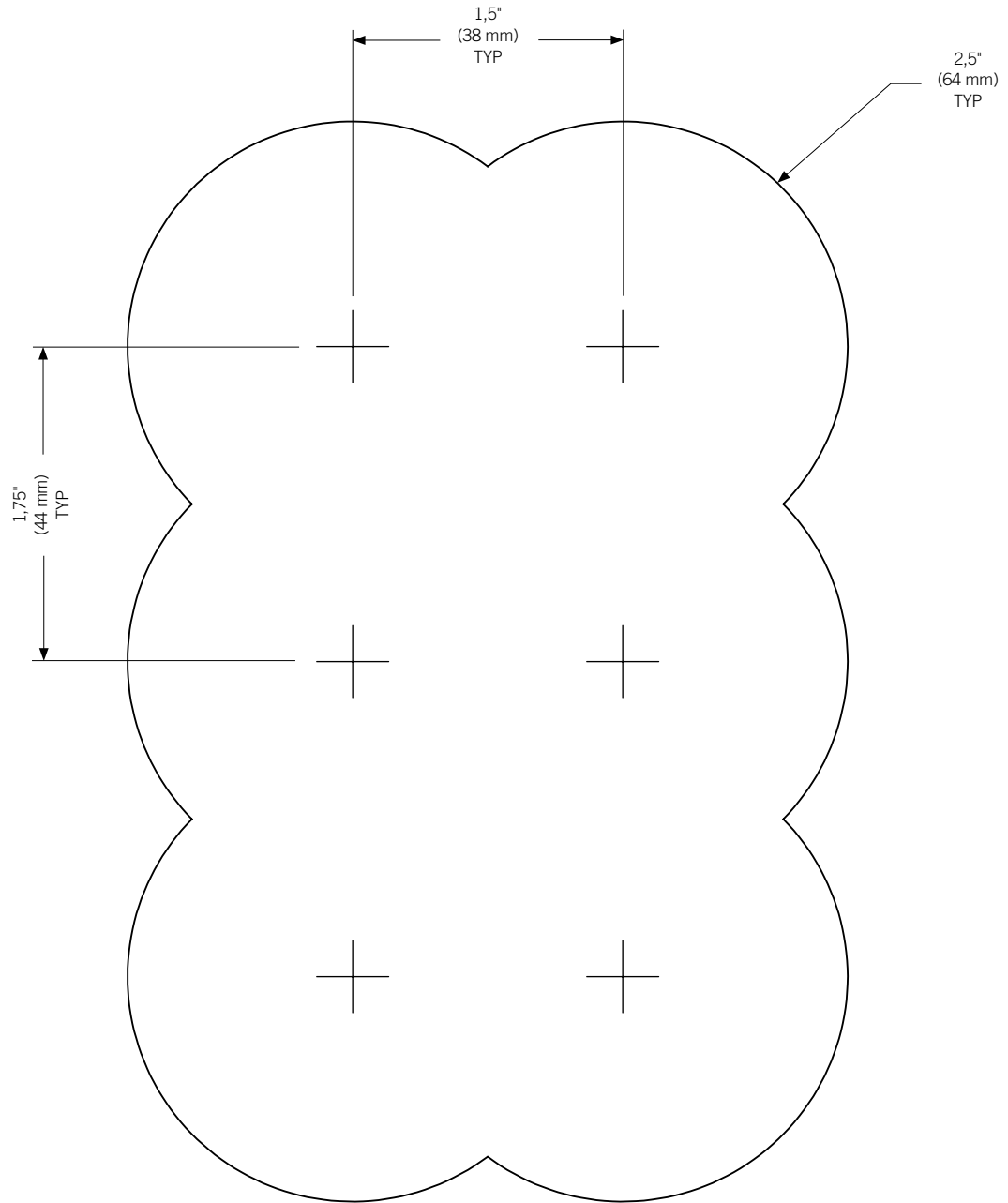



Installation

Installation notes

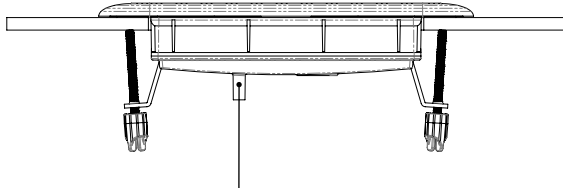

The vent hole on back of keypad should not be blocked.

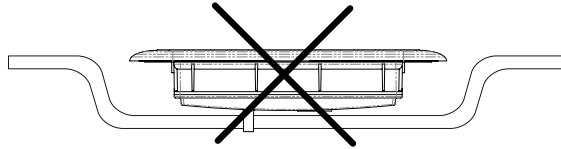

The back of the in.k1000 should not be enclosed where water can gather, but instead cut out.

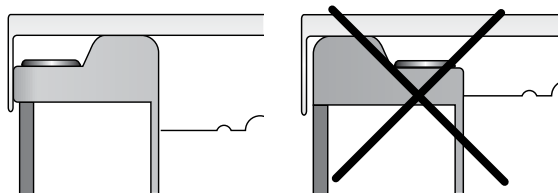

The in.k1000 must be installed on the outside edge of the hot tub, so that it is not subject to moisture trapped by the cover.

Connecting in.k1000 to the spa pack

Main keypad in.k1000

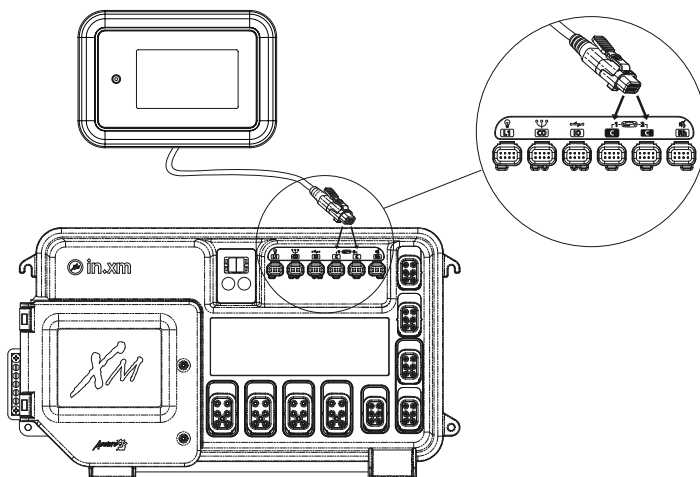

To connect the in.k1000 keypad, simply insert its in.link connector into the appropriate keypad connector of the pack enclosure (as illustrated).



Installation

Upload

The spa pack does not have valid software. Please insert valid in.stick to reprogram spa pack.

WARNING

There's a problem communicating with the pack. Please check keypad connections or update pack software.

Installation errors

Upon connecting the in.k1000 to the spa pack you may see one of two error messages.

Please follow the instructions in the message or contact your dealer for more information.



Keypad functions

in.k1000 keypad layout

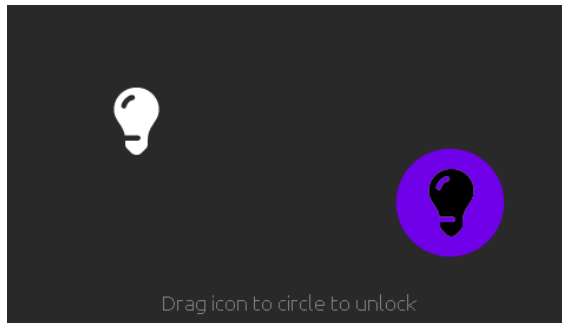

Power

Touch the screen to turn on the keypad. 3 minutes after the last pump is turned off, the screen will shut off if there is no touch activity.

Then follow the instructions on the screen to access the main screen.

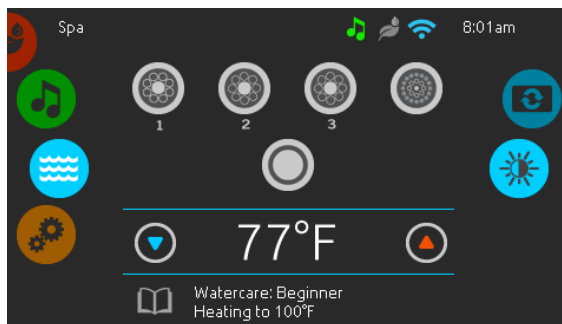

Main screen

The main screen gives you access to your accessories and water temperature. At the bottom of the screen you will see any error or maintenance messages that are present.

Keypad functions

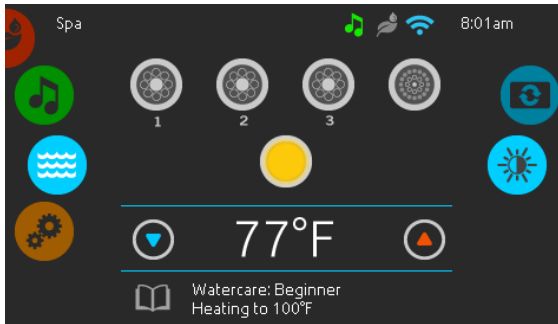

Start or stop accessories

To start or stop an accessory, touch the associated icon. Icons will become animated when their accessory is turned on, and animation will stop when turned off. Icons on the screen will reflect the speed or state of the devices running on your spa. When an accessory has more than two speeds press the button until it reaches the desired speed.

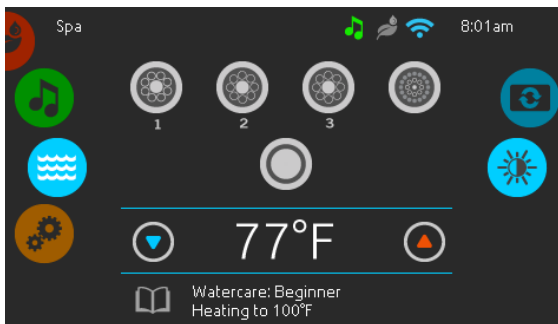



Notifications

A notification area at the top right-hand side of the screen shows the state of certain accessories installed in the spa.



Notification icons

in.touch:

-  Indicates that the in.touch module is detected and connected to a Wi-Fi network.
-  A red cross indicates that the in.touch module is detected but isn't connected to a Wi-Fi network.
-  An animated icon indicates that the in.touch module is connecting to a Wi-Fi network.



For more information about the in.touch, refer to the Wi-Fi section.

in.clear:

-  The icon is green when the in.clear is generating bromine.
-  The icon is grey when the in.clear isn't generating bromine.
-  A red cross indicates that the in.clear is turned off.

For more information about the in.clear, refer to the in.clear functions section.

in.stream 2:

-  The icon is green when the in.stream 2 is on.
-  The icon is grey when the in.stream 2 is off.

For more information about the in.stream 2, refer to the in.stream 2 functions section.



Keypad functions

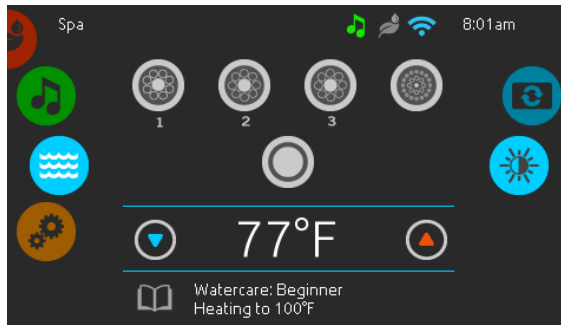

Water temperature

The temperature shown at the bottom of the screen shows the current water temperature. Use the Up and Down icon to set the desired temperature. The set point will appear in blue. After 3 seconds without any change to the set temperature value, the current water temperature will reappear.

When the set value is lower than the current temperature Cooling to xx.x will appear below. When the set value is higher than the current temperature, Heating to xx.x will be indicated under the value. Normally there is a short delay before the heating starts, during which Heating Suspended is indicated under the value.

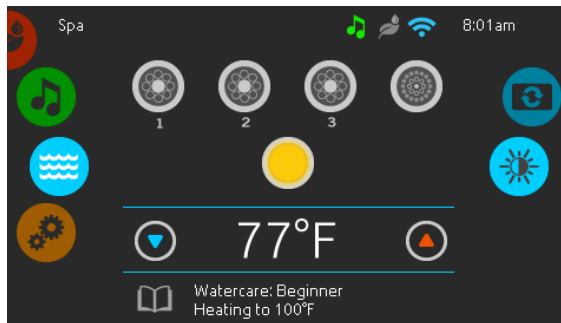

Spa menu

From the home page you can access the following:

- *in.clear* (if installed)
- *in.stream 2* (if installed)
- *spa menu*
- *settings*

To select an option, slide the left wheel up or down until the desired icon menu is highlighted in the middle.

On the right side is a menu for access to the Display and Contrast pages.

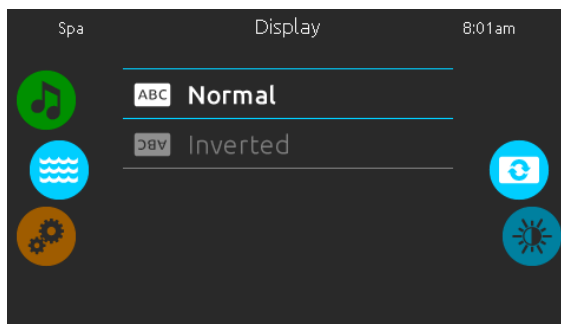

Display page

Use this page to change the display orientation.

Keypad functions

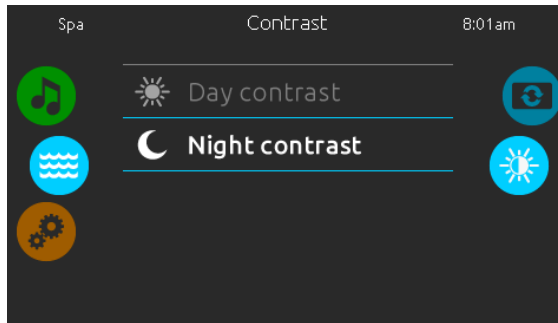

Contrast page

Use this page to change the display contrast.

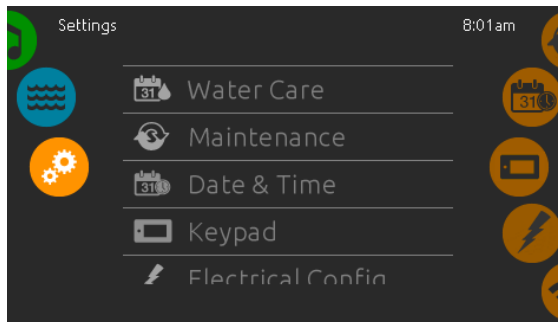

Settings

In the Settings page you can access the following:

- *WaterCare*
- *Maintenance*
- *Date & Time*
- *Keypad*
- *Electrical Config*
- *Wi-Fi*
- *About*

To select an item, slide the right wheel until the desired icon is highlighted in the middle or press on the menu name.



Keypad functions

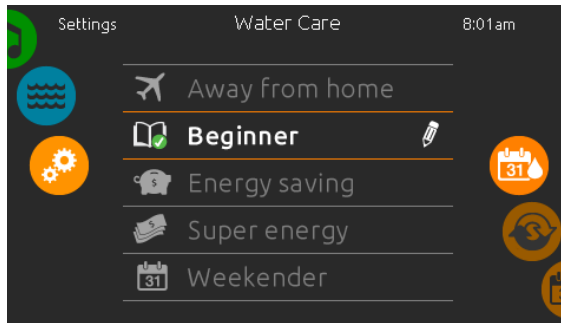

Water care

The Water Care page will help you set up your ideal filtration and heating settings. Choose between *Away from Home*, *Beginner*, *Energy Savings*, *Super Energy* and *Weekender*, depending on your need. Touch the Water care name to choose your setting. A green checkmark will appear on the selected icon to confirm your choice .

In Economy mode, the set point will be reduced by 20°F*, which means that the heating system will not be engaged unless the temperature falls to 20°F below the spa's set temperature.

The filtration schedule shown on the screen will apply to the main filtration pump, most likely pump 1. If your spa uses a circulation pump configured to run 24 hours, the screen will show you the purge setting instead of filtration. The purges are pre-programmed for a fixed number of minutes, therefore the duration will be set to N/A on the screen, and only the start time can be modified.

* Default pack value

Water care modes



Away:

In this mode the spa will always be in economy; the set point will be reduced by 20° F.



Beginner:

The spa will never be in economy mode and will be filtering according to the pack's low level configuration.



Energy Savings:

The spa will be in economy mode during the peak hours of the day and resume normal mode on the weekend.



Super Energy Savings:

The spa will always be in economy mode during peak hours, every day of the week.



Weekender:

The spa will be in economy mode from Monday to Friday, and will run normally on the weekend.

Keypad functions

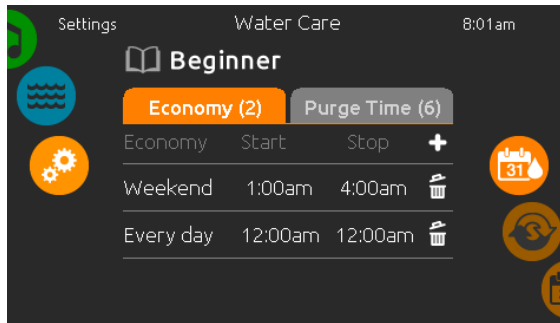

Modifying schedules

To modify a Water Care category, touch the pen icon at the right end of the desired watercare to open the selected Water Care menu.

Touch the Economy tab to change the economy setting and filter cycle tab for the filtration settings (or schedules). You can add economy or filtration schedules by touching the « + » symbol .

To delete a schedule, touch the garbage can icon at the right end of the desired line.

You can modify the programmed schedules by selecting one and adjusting the schedule.

You have several possibilities for the schedule (Mon-Fri, weekend, every day, or single days). The schedules will be repeated every week. The time and duration are set in 30 minute increments. Once you have set the schedule, use the calendar icon to go back. Ensure that you have selected the desired Water Care mode in the main Water Care menu.

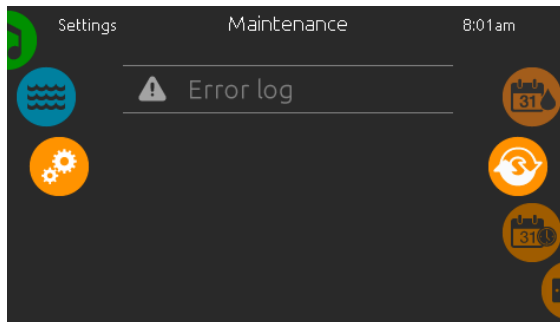
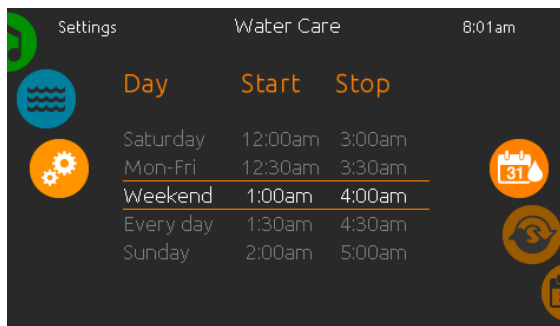

Maintenance

From the Maintenance page you can access the following:

- *Error log*

To access the desired option simply touch the desired menu item.

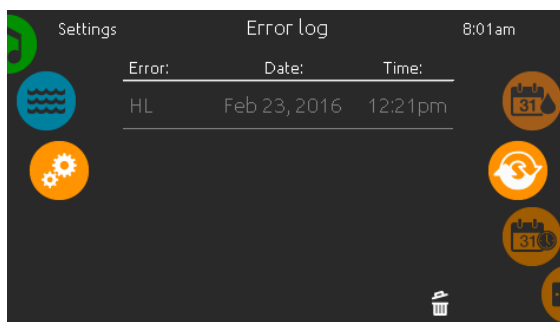

Error Log

In this section you can see errors that have been archived by the system. Drag the list Up and Down to move through the list. Errors are archived chronologically, from the most recent at the top to the oldest at the bottom.

The Error log page shows the error code, the date of the error, and the time. Touching the garbage can icon will delete the Error log (with a confirmation).

For more information, see the Error messages section.



Keypad functions

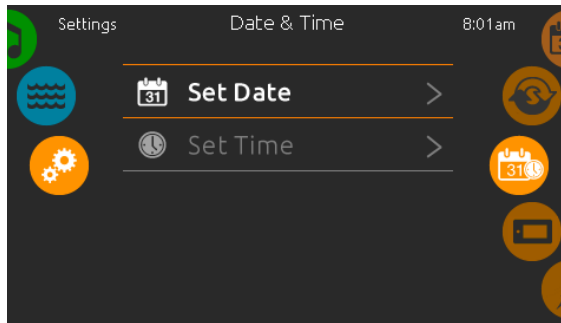

Date and time

Simply touch the item you want to change.

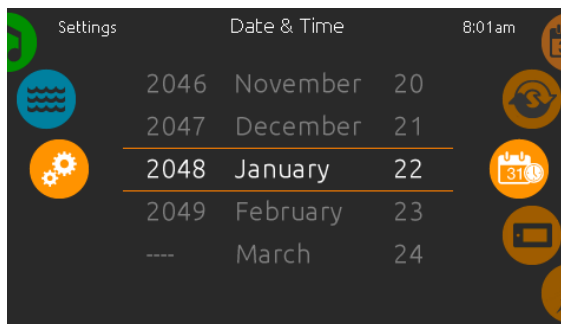

Set date

Here you can adjust the year, month and day.

Simply swipe up and down the column you want to change, and select the desired value. When done, touch the calendar icon at the right of the screen.

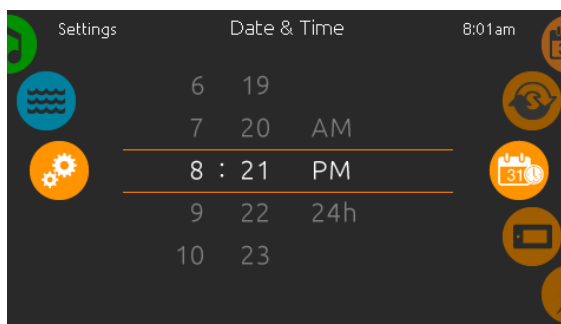

Set time

Here you can change the hour, minute and time format.

Simply swipe up and down the column you want to change, and select the desired value. When done, touch the calendar icon at the right of the screen.

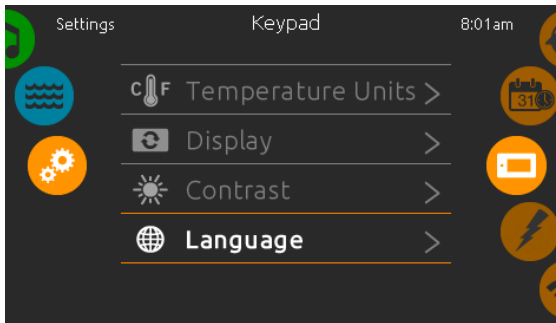

Keypad settings

Here you can adjust the Temperature Units, Day/Night contrast, and Display orientation and language.

Simply touch the item you want to change.

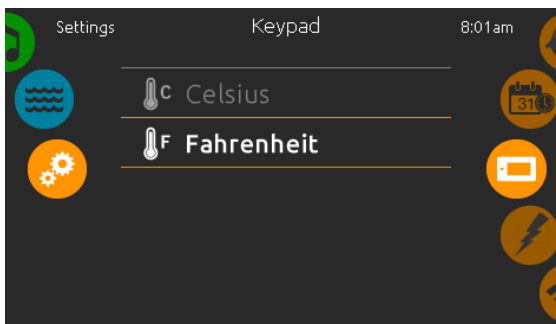

Temperature units

Choose the appropriate units to display temperatures.

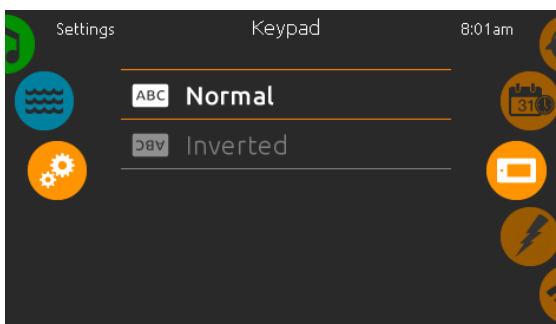

Display page

Use this page to change the display orientation.



Keypad functions

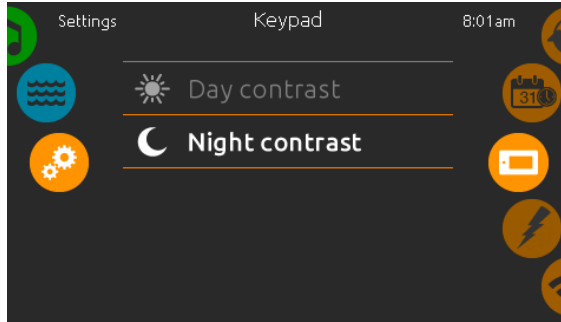

Contrast page

Simply touch the item you want to change.

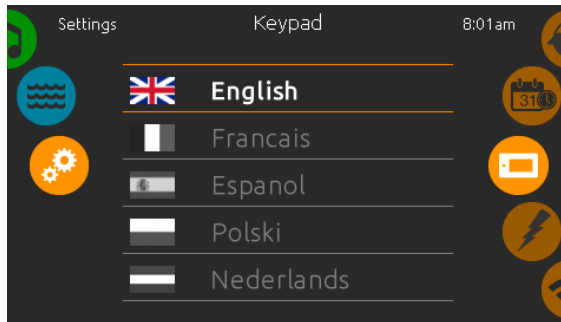

Language Select

Use this page to select the display language of the in.k1000 keypad.

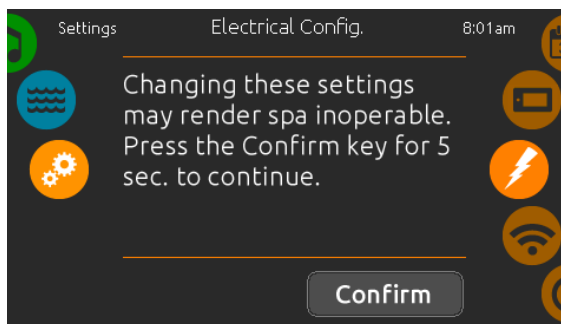

Electrical configuration

Please do not make changes in this section unless you are a qualified electrician.

In this section you can change the low-level configuration, as well as modify the number of phases and the input current.

Please note that if there are two spa packs in the system (i.e. a SwimSpa installation), the master unit's chosen configuration must support a slave unit. If, after re-booting, the chosen configuration does not support SwimSpa installations, the in.k1000 will return (after about 45 seconds) to this configuration menu and prompt the user to select a configuration number again.

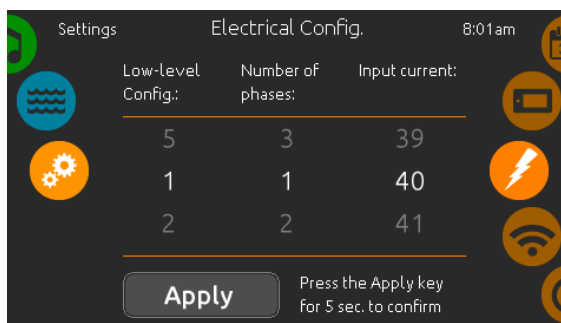

Keypad functions

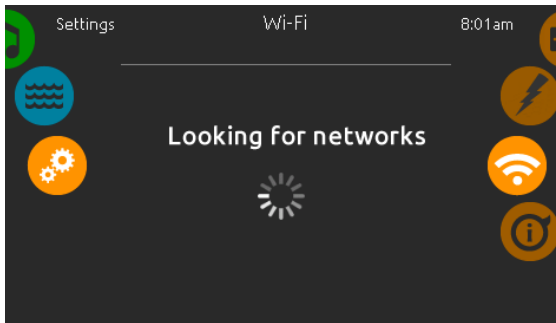

Wi-Fi

This menu is present if the in.touch module is present. This page allows you to connect your in.touch module to a Wi-Fi network or to change its network.

For more details about other in.touch connection methods please see the in.touch techbook.

After a few seconds the available networks will appear on the screen, as well as their signal strength.

Swipe Up or Down the list to select your network.

If the Wi-Fi network is password protected enter it when prompted. Use Enter to validate the password.

If no password is required the in.touch will connect automatically.

Once the in.touch module is connected to a Wi-Fi network a green check mark will appear in the Wi-Fi menu, and the network name will appear in the *Settings* menu.

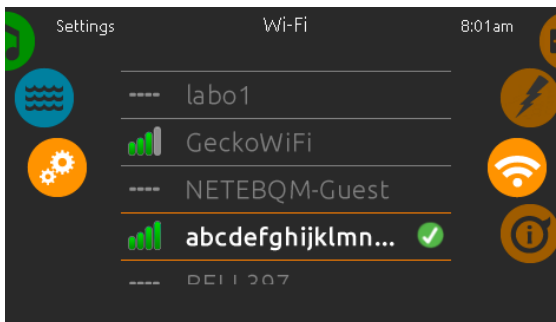

About

This section shows information about the in.k1000 software number, and the revision numbers of the different components of your system.

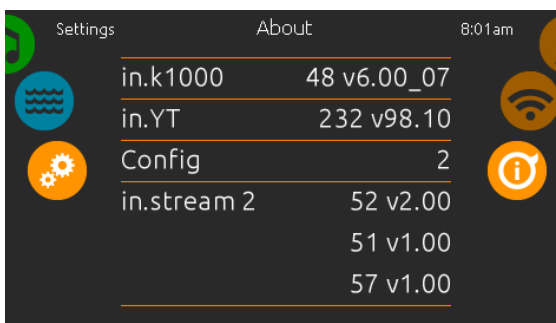



Keypad functions



Wipe screen

This message appears when too much water is detected on the touch screen. Simply wipe away excess water.



in.stream 2 functions

This menu is available only if the in.stream 2 audio station is detected in the spa accessories.

The audio page will allow you to control the active audio source. Note that only the functions that apply to the selected source will be available. From this page, you can also access the following:

- *in.stream 2 on/off*
- *speaker settings*
- *audio source selection*
- *disconnect bluetooth*

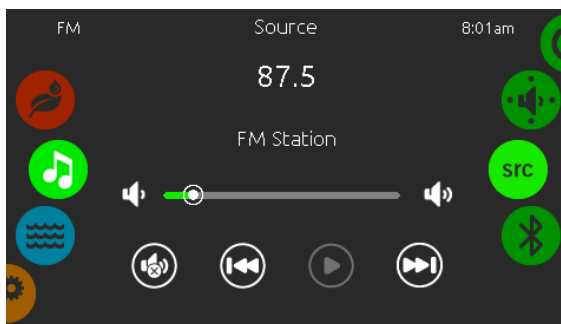

To select an item, slide the right wheel until the desired icon is highlighted in the middle.

For more information about the in.stream 2 audio station, please refer to the in.stream 2 techbook.

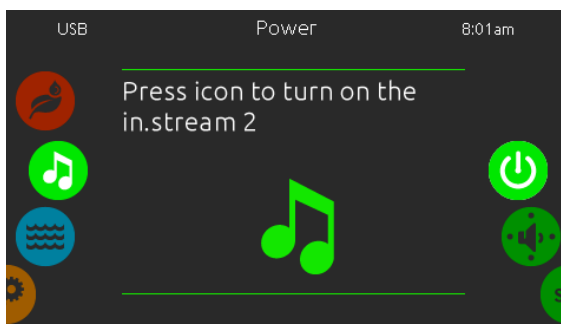

Power

To turn the in.stream 2 on or off, tap the icon located in the center of the screen.

Keypad functions

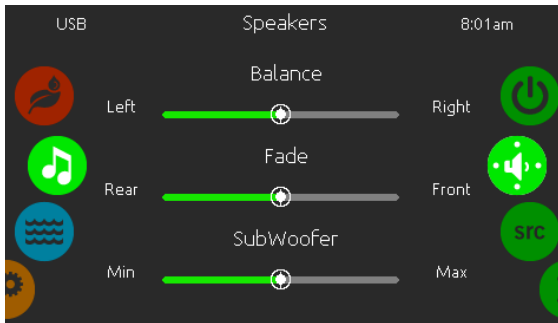

Speakers Settings

Move the sliders to adjust the Balance, Fader and subwoofer settings.

The Fader and Subwoofer sliders will only appear in the Speaker menu if the corresponding speakers are installed on the in.stream 2.

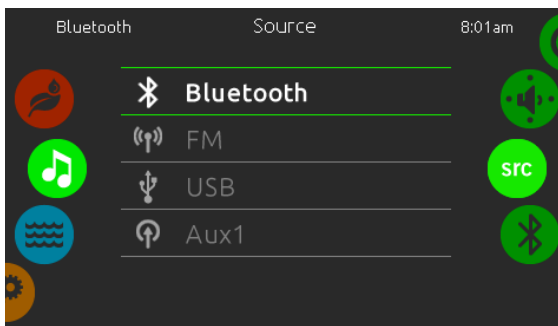

Source Menu

To change the audio source, simply tap on the desired one.

Note that only the sources installed on the in.stream 2 will be displayed in the source menu.

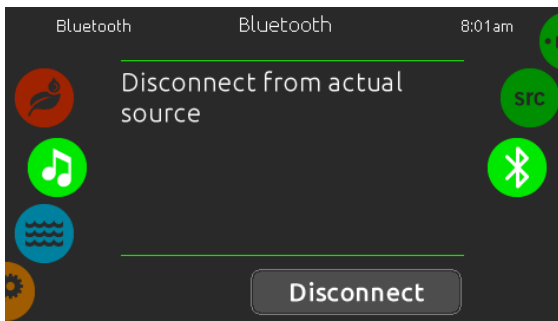

Disconnect Bluetooth

If a device with Bluetooth technology is connected to the in.stream 2, you can disconnect it by pressing the Disconnect button at the bottom of the screen.

Doing so will also prevent the in.stream 2 from automatically reconnecting to this specific device until it has been reconnected using the device itself.

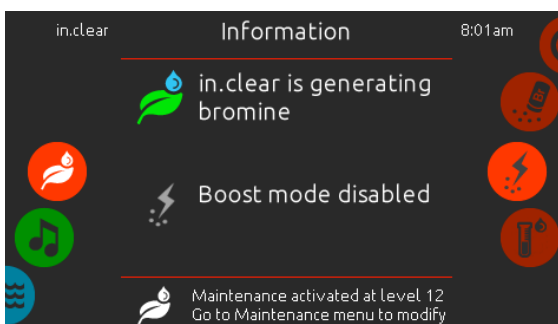

in.clear functions

This menu is available only if the in.clear is detected in the spa accessories.

The k1000 keypad can be used with the in.clear sanitation system.

The *in.clear* menu allows you to configure your maintenance settings and boost levels. The main *in.clear* menu shows the current status of the sanitation system, whether it's on, and if it's generating bromine or not.

For more information about the in.clear, bromine levels, and other settings, please refer to the in.clear user manual.



Keypad functions

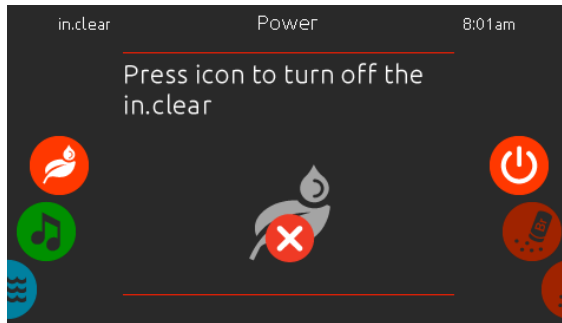

in.clear on/off

Use the On/Off submenu to turn on or off the in.clear sanitation system.

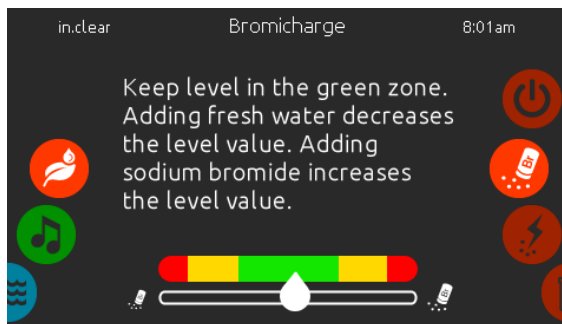

Bromicharge™ level

The Bromicharge page allows you to see the current level of sodium bromide in the water. Ideally, you should aim to be near the center of the green area of the gauge. Follow the instructions given on the screen to increase or reduce the level.

Note that it may take a few moments to obtain a reading from the in.clear, during which time the wait icon is displayed on the gauge.

There are no settings to change on this page, it is informative only.

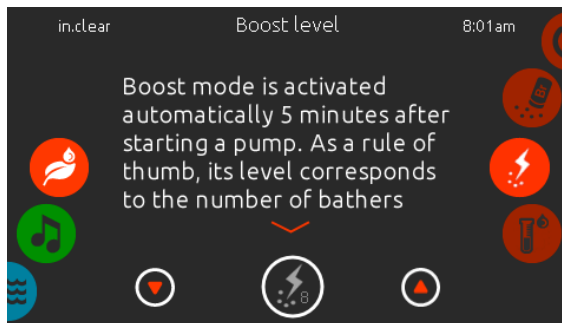

Modify the Boost level

The Boost level is used to set amount of boost required. As a rule, enter the number of bathers in the bath. Boost mode is automatically activated 5 minutes after starting a pump.

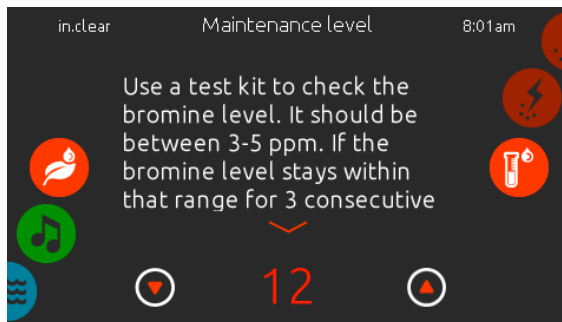

Modify the maintenance level

The maintenance level can be changed, and must be tested with a bromine level tester. The tester should report between 3-5 ppm. If the bromine level is within this range for 3 consecutive days, your maintenance level is correctly adjusted. If you adjust the Maintenance level by more than 2, you will be asked to confirm this.



Error messages

The list below shows the different error messages that can appear on the home screen.

Refer to the troubleshooting and error codes section of the TechBook for your spa pack system.

Please note that if you are in a swim spa configuration, the message may be followed by "Master" or "Slave" to designate from which pack the error is coming from.

Code	Message
HL	High Limit circuit has tripped!
FLO	No Flow condition for more than 2 hours
FLO	No Flow condition
HR	A hardware error was detected (Relay stuck)
OH	Spa temperature is too high
Pr	Temp probes or detection circuit are defective
AOH	Elevated internal temperature
FLC	The pressure switch is closed
SP in	Input voltage issue
RH NC	Comm. error between in.xm2 - in.therm
RH ID	in.xm2 and in.therm incompatible
SC ER	Error detected during the learning mode
F1	in.xm2 Fuse # 1 is blown
F2	in.xm2 Fuse # 2 is blown
F3	in.xm2 Fuse # 3 is blown
ER1	SwimSpa config. : slave unit is missing
Hr	Hardware error was detected (Thermal fuse)
UPL	The spa pack does not have valid software. Please insert valid in.stick to reprogram spa pack.
CFLO	No Flow condition
HIBr	Add fresh water to the spa
HiBr	Add fresh water to the spa
LoBr	Add BromiCharge to spa water
NoBr	Add BromiCharge to spa water
Comm	Verify cable connections
Supp	Connect power cord to 240 V source



Feature matrix

The following table presents the features and/or options available for the in.k1000 keypad, and the earliest software version at which this feature/option is available. All versions greater than the earliest version continue to support the feature.

Keypad functions	Earliest support
Power	5.00
Main screen	5.00
Start or stop accessories	5.00
Notifications	5.00
Water temperature	5.00
Spa menu	5.00
Settings	5.00
Water care	5.00
Water care modes	5.00
Modifying schedules	5.00
Maintenance	
Error log	5.00
Date and time	
Set date	5.00
Set time	5.00
Keypad settings	
Temperature unit	5.00
Display	5.00
Contrast	5.00
Language	
English	5.00
Français	5.00
Español	5.00
Polski	5.00
Nederlands	5.00
Deutsch	5.00
Norsk	5.00
Svenska	5.00
Magyar	5.00
Italiano	5.00
Português	5.00
Electrical configuration	5.00
Wi-Fi	5.00
About	5.00
Wipe screen	6.00
in.stream 2 functions	5.00
in.clear functions	7.00
Support for AC Light output	8.00
Support for in.xe-2 and in.ye-2 packs	8.00



Specifications

Part number

0607-005024

Model

IN.K1000-BK-GE1

Environmental

Operating temperature:	-4°F (-20°C) to 149°F (65°C)
Storage temperature:	-22°F (-30°C) to 185°F (85°C)
Water ingress protection:	IPX5

Mechanical

Weight:	1.05 lbs (0.48 kg)
Dimensions (W x H x D):	7,49" x 5,17" x 1,93" (190 mm x 1031 mm x 49 mm)

Audio specifications

Audio source supported:	in.stream 2
--------------------------------	-------------

Compatibility

in.yt, in.ye, in.yj, in.xe, or in.xm2 spa packs with appropriate software revision

Specifications are subject to change without prior notice.



9919-101309-C
Rev. 02-2016

© Groupe Gecko Alliance inc., 2016
All trademarks or registered trademarks
are the property of their respective owners.

Gecko Alliance
450 des Canetons, Québec (Qc), G2E 5W6 Canada, 1.800.78.GECKO
www.geckoalliance.com

Printed in Canada