

# LUXOR<sup>®</sup>

## WI-FI COMPONENTS

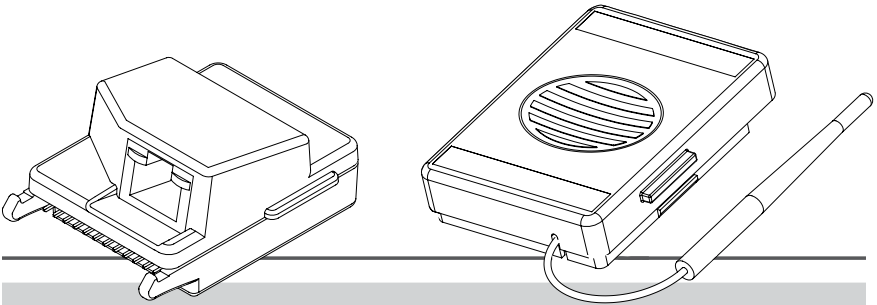

**Quick Start Guide**

**FXLuminaire<sup>®</sup>**

# Wi-Fi Components

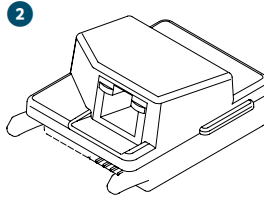
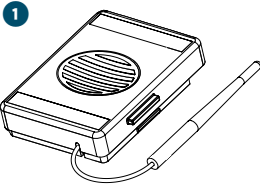

## General Information

- **WI-FI CONNECTION**
  - Signal Strength: 70+ RSSI
  - 2.4 GHz routers only
- **LAN**
  - max 300 ft. Ethernet cat5 cable connection between Luxor and router
- **SUPPORT VIDEOS:** [www.fx1.com/luxorvideos](http://www.fx1.com/luxorvideos)

## Wi-Fi/LAN Module Installation

- Insert **WIFIMOD 1** or **LANMOD 2** into facepack

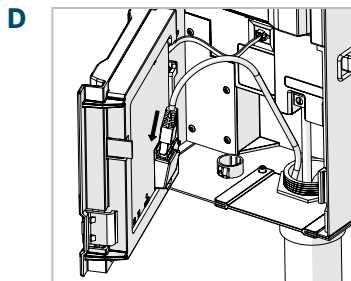
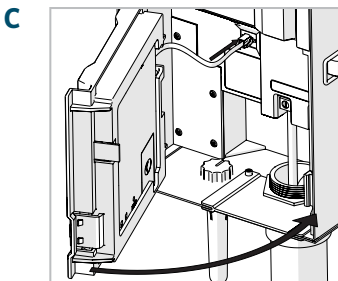
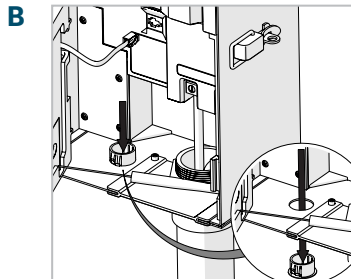
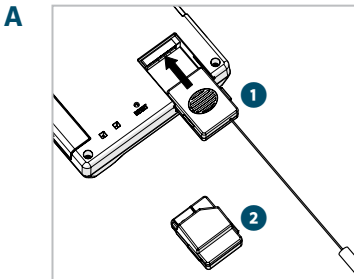

# Wi-Fi Direct Connect Setup

- Install **WIFIMOD 1** into facepack
- Select **SETUP**
- Select **WI-FI**
- In Wi-Fi Setup screen, confirm **WIFI: DIRECT CONNECT READY**



# Wi-Fi Network Connect Setup

- Install **WIFIMOD 1** into facepack
- Select **SETUP**
- Select **WI-FI**
- Select **NETWORK**
- Select desired network from list of **AVAILABLE NETWORKS**
- If network is secured, enter Wi-Fi Password

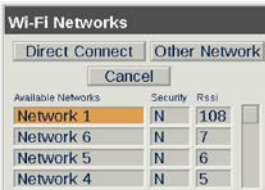

# LAN Network Connect Setup

- Install **LANMOD 2** into facepack
- Select **SETUP**
- Select **LAN**
- Confirm LAN is **CONNECTED**



Find more information about your product, including tips on installation, programming, and more.



 [fxl.com/luxorhelp](http://fxl.com/luxorhelp)

 1-800-733-2823