



# Installation and Operation Manual

Models: Power Defender 165 & 270 for Waterway

Programmable Pool Pump Motor/Control



This product does **NOT** provide a Safety Vacuum Release System (SVRS).

Save this instruction manual for future reference.

# Table of Contents

<b>Important Safety Information</b> .....	<b>1</b>
<b>About the Power Defender 165 &amp; 270 for Waterway</b> .....	<b>3</b>
Features.....	3
Dimensions .....	4
<b>Electrical Requirements</b> .....	<b>5</b>
Input.....	5
Rated Output.....	5
<b>Agency</b> .....	<b>6</b>
Safety Standards.....	6
<b>Installation Instructions</b> .....	<b>7</b>
Protect against Heat.....	7
Protect against Dirt.....	7
Protect against Moisture.....	7
Preparing the Pool Pump Motor for Operation.....	7
Wiring the Pool Pump Motor.....	8
Wiring the Auxiliary Load Relay (optional).....	10
<b>Protections</b> .....	<b>11</b>
Control Unit Temperature .....	11
Low Input Line Voltage.....	11
Low Temperature Monitor .....	11
Motor Stalled.....	11
Open Output Phase.....	11
Output Over Current.....	11
Output Over Power.....	11
Hardware Protection.....	12
Mechanical Requirements .....	12
Environmental Requirements .....	12
<b>Pump Control via the User Interface</b> .....	<b>13</b>
Navigation Overview .....	13
Configure Your Pool Pump Motor.....	19
Overriding a Timer.....	23
<b>Pump Control via the Drive Interface Board</b> .....	<b>24</b>
Discrete Switch Inputs.....	24
RS-485 Port .....	25
<b>Troubleshooting</b> .....	<b>27</b>
Basic Troubleshooting.....	27
General Troubleshooting.....	28
Fault Conditions .....	29
<b>Maintenance</b> .....	<b>33</b>
Lowering Your Utility Costs .....	33
Example Calculations.....	33
<b>Default Settings</b> .....	<b>34</b>
<b>Warranty Information</b> .....	<b>35</b>
<b>Notes</b> .....	<b>36</b>

## Important Safety Information

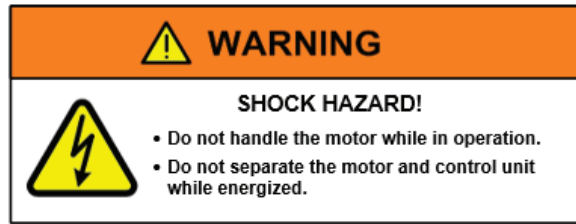

### WARNING

- Read all instructions thoroughly and be familiar with the equipment before installing or working on it.
- **DO NOT** lift the pool pump motor by the control unit.
- Before connecting or disconnecting cables or other electrical connections, verify that the electrical power to the system is removed. Failure to comply may cause serious damage to the pool pump motor or pump system or injury.
- There are no serviceable parts in the pool pump motor or control.
- Because of the risk of electric shock, only individuals thoroughly trained in the use of multimeters should conduct electrical tests.
- Never touch the metal contacts on the multimeter during a test.
- Always check testing equipment for proper operation before use.

### WARNING

Installation, operation, and maintenance must be performed by qualified personnel. Familiarization with and adherence to the National Electrical Code (NEC), National Fire Protection Association (NFPA) standards and to local codes are required. It is important to observe safety precautions to protect personnel from possible injury. Personnel should be instructed for handling each of the following:

- Insulate all connections carefully to prevent grounding or short circuits. Reinstall all conduit and terminal box covers.
- To avoid overheating, voltage to the motor control unit must be within plus or minus 10% of the nameplate voltage.
- Make sure the unit is electrically grounded and that proper electrical installation, wiring, and controls are used consistent with local and national electric codes. Refer to **NEC Handbook and NFPA No. 70**. Employ qualified electricians for the installation and maintenance of the unit.
- Code requirements differ from state to state. Install equipment using qualified electricians in accordance with the applicable codes and ordinances in your area and in accordance with NEC. All electrical connections should be made and maintained by a qualified or licensed electrician.
- Make sure there are no unusual noises or vibrations when the pool pump motor is running.
- Avoid contact with energized circuits and rotating parts.

## Power Defender 165 & 270 for Waterway

### WARNING

- Always disconnect electrical power at the fuse box or circuit breaker panel before handling electrical connections or performing maintenance on this unit. Allow the pool pump motor to come to a complete stop and wait four (4) minutes. This allows the capacitors to discharge any residual voltage for safety.
- All aspects of the installation must conform to the applicable requirements of the NEC, including **Article 430 (Motor Circuits and Controllers)**, as well as all local codes.
- Double-check to make sure that electrical power is removed and that it cannot be turned on while you are working on the equipment.
- A poor electrical connection can overheat and cause terminal and/or terminal board failures. Examine the connections carefully for any signs of physical deterioration or loose fit to the motor terminal block.
- Care must be taken to assure connections are made to the proper terminals and adequate electrical clearances are maintained.
- The control unit on the pool pump motor contains hazardous voltage.

### CAUTION

- Wear safety glasses to inspect the equipment while it is running or while working on equipment.

### NOTICE

The pool pump motor and control unit are assembled and calibrated as a set. There are no serviceable parts in the motor or control.

- To prevent permanent damage to the unit, only apply nameplate voltage.
- **DO NOT** strike the pool pump motor shaft with a hammer or other tool as this may cause damage.
- Voltage symbols vary among different multimeters and may be displayed as Vac, AC, V, or a V beneath a wavy line. Select the correct symbol and set the multimeter to the voltage closest to but higher than the voltage you are measuring.
- Although designed for outdoor application, the pool pump motor is properly packaged for shipment and storage and should be kept in a clean and dry indoor area until installed for use.

## About the Power Defender 165 & 270 for Waterway

The Power Defender 165 & 270 for Waterway variable speed pool pump motor is a premium efficient product that includes a fully integrated motor, control, and User Interface (UI). The product gives you programming flexibility and exceptional speed range capability. It is also designed to communicate and operate with a variety of external system controls, in addition to the on-board User Interface.

### Features

- Total Output Horsepower (THP): 1.65 & 2.7 THP at 3450 RPM, variable speed
- Input Voltage/Hertz: Single phase, 115 and 230 Vac, 50 or 60 Hz
- Automatic Voltage Sensing
- Power Factor Correction: 94-97%
- Speed Range: 600-3450 RPM
- Nominal Efficiency: 1.65 THP 81% at 3450 RPM, 2.7 THP 85% at 3450 PRM
- Enclosure: Finned Aluminum enclosure providing a Water Ingress Protection level of IPX5 for long field life in outdoor environmental conditions
- Frame: Square Flange
- User Interface: Fully functional, easy to operate, capable of 90°, 180°, or 270° rotation
- Rotation: Counter-clockwise (CCW), viewing motor shaft
- Low Temperature Monitor: Threshold temperature configurable in the UI
- Fully Integrated: Designed for simple “Drop-In” installation with no complex wiring
- Auxiliary Load Relay
- Capable of communicating with specific pool control systems via MODBUS RTU
- Capable of setting up to seven daily schedules
- Adjustable priming time & speed
- Menu keypad lockout
- Designed for quiet operation
- UL 1081 approvable



Square Flange

# Power Defender 165 & 270 for Waterway

## Dimensions

All dimensions are for reference only.

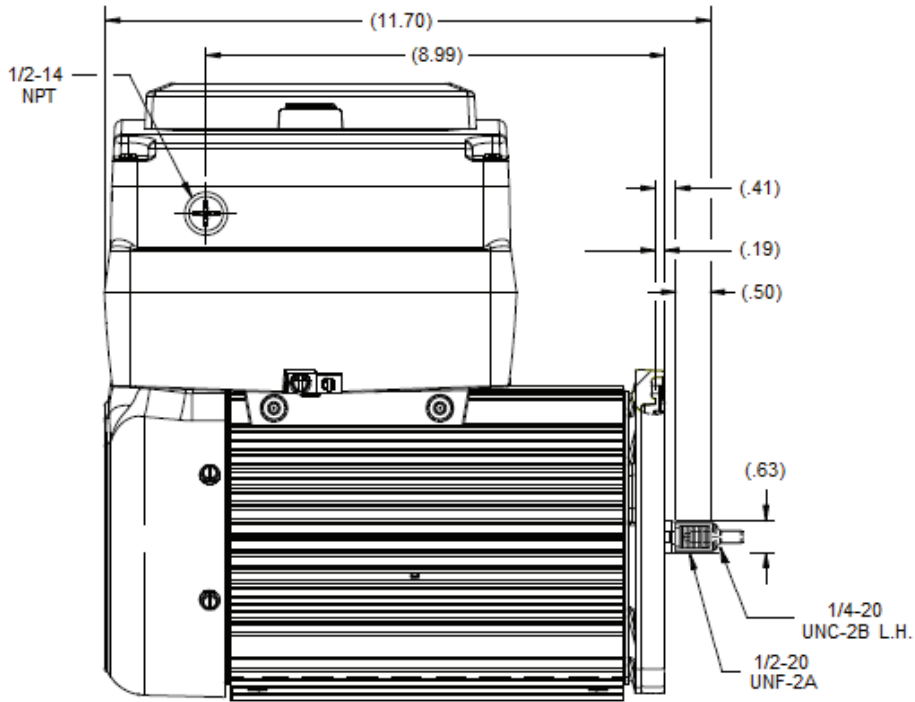

Side View

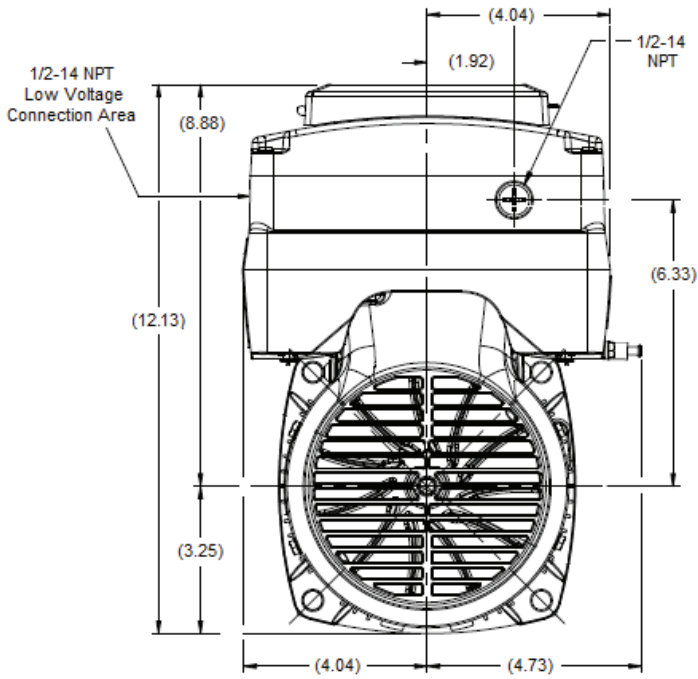

Fan View

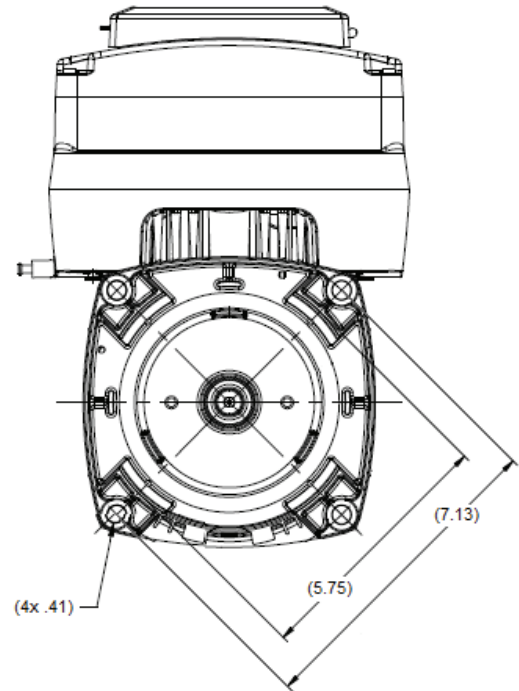

Shaft View

## Electrical Requirements

The 1.65 THP pool pump motor is a Dual Voltage Model (115 or 230 Vac), while the 2.7 THP is a Single Voltage Model (230 Vac only). Voltage selection is automatic. The control senses the input line voltage and then operates the pool pump at the applied input voltage.

### Input

#### Input Line Voltage

The unit is intended to be operated from a 115 (1.65 THP only) or 230 Vac single phase power supply. The input AC supply frequency is 50 or 60 Hz nominal. Full rated output power is supplied between the Minimum Full Performance Voltage and the Maximum Operating Voltage. The unit operates with frequency variations up to +/-10 percent of the nominal value.

Line Input 1Ø	Minimum Full Performance Voltage	Maximum Operating Voltage
115 Vac	104 Vac	127 Vac
230 Vac	208 Vac	254 Vac

#### Input Line Current (Amperage)

Full load AC line currents are listed below. The inverter limits the inrush current to less than 150A peak surge. The duration is less than 5 milliseconds.

AC Input	Total Horsepower	Full Load Current
115 Vac	1.65	13.6 Amps
230 Vac	1.65	6.8 Amps
230 Vac	2.70	11.1 Amps

#### Input Power Factor

There is a power factor correction circuit on the motor control board. Power factor range is normally 94 to 97%.

### Rated Output

The unit is rated for the following maximum outputs:

1.65 THP	2.70 THP
30 in-lb	49.2 in-lb
600-3450 RPM	

## Agency

UL File Number:

- E255002 (motor)
- E97751 (control)

## Safety Standards

Document	Description
UL 60730-1	Automatic Electrical Controls for Household and Similar Use – General Requirements
UL1004-1	Rotating Electrical Machines – General Requirements
UL1004-7	Electronically Protected Motors
UL1081	Swimming Pool Pumps, Filters, and Chlorinators
CSA C22.2, No. 77	Motors with Inherent Overheating Protection
CSA C22.2, No. 100	Motors and Generators
CSA C22.2, No. 108	Liquid Pumps



## Installation Instructions

Follow these instructions to prolong the life of the pump motor and control. Install the product on a secure and level platform or base, such as a concrete pad.



Installation, operation, and maintenance must be performed by qualified personnel. Familiarization with and adherence to the National Electrical Code (NEC), National Fire Protection Association (NFPA) standards and to local codes are required. It is important to observe safety precautions to protect personnel from possible injury.

- Code requirements differ from state to state. Install equipment using qualified electricians in accordance with the applicable codes and ordinances in your area and in accordance with NEC. All electrical connections should be made and maintained by a qualified or licensed electrician.

### Protect against Heat

- Shade the motor / control from the sun.
- Provide ample cross ventilation.
- Protect the motor / control from lint, etc., which can clog the ventilation openings.

### Protect against Dirt

- Keep the motor / control and the surrounding area clean.
- Avoid sweeping or stirring dust near the motor / control while it is running.
- Avoid storing or spilling dry chemicals near the motor / control.

### Protect against Moisture

- Provide protection from rain, snow, etc.
- **Do not** wrap the motor / control with plastic or other air tight materials.
- Locate the motor / control on a slight elevation so that water does not run or puddle nearby.
- Avoid splashing water on or near the motor / control.
- Repair leaky pipe joints or pump seals promptly.

## Preparing the Pool Pump Motor for Operation

The motor has been functionally tested before shipment. Most pool installations already have the electrical power in conduit. However, on-site installation requirements and electrical codes vary widely and are the responsibility of the installer. The unit must be wired before operating.

**Note:** An electrical power cable is **not** provided.

You will need the following tools.

- 1/4 socket or nut driver
- Flathead or Phillips screwdriver

## Wiring the Pool Pump Motor

The 1.65 THP pool pump motor is a Dual Voltage Model (115 or 230 Vac), while the 2.7 THP is a Single Voltage Model (230 Vac only). Voltage selection is automatic. The control senses the input line voltage and then operates the pool pump at the applied input voltage.

### **WARNING**

- Always disconnect electrical power at the fuse box or circuit breaker panel before handling electrical connections or performing maintenance on the motor. Allow the motor to come to a complete stop and wait four (4) minutes. This allows the control bus capacitors to discharge any residual voltage.
- The control unit on the motor contains hazardous voltage.

Follow the steps outlined below to wire the motor.

1. Remove the four (4) slotted head hex washer screws securing the User Interface Cover to the wiring compartments (Figure 1). Set the cover aside.

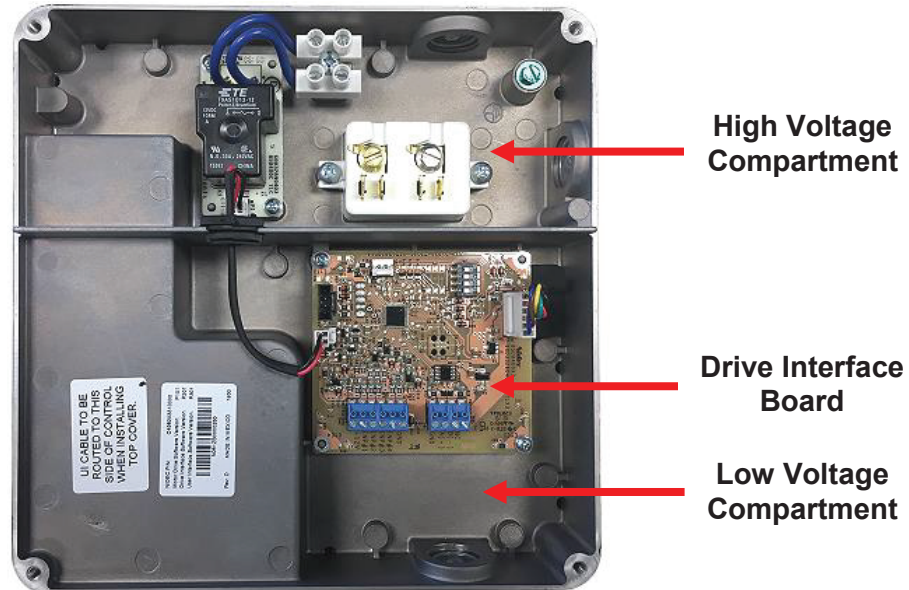
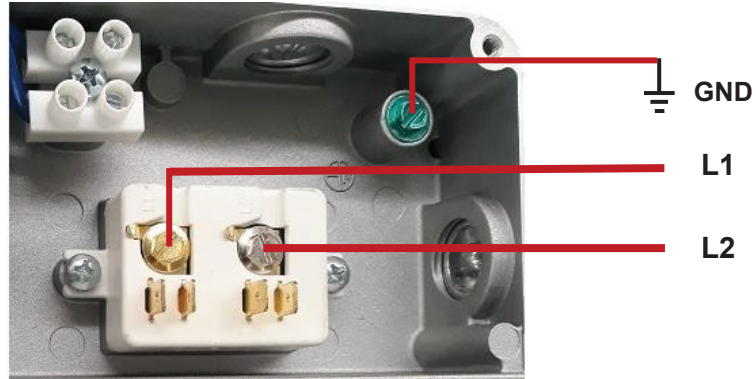

**Figure 1 – High and Low Voltage Compartments**

2. Voltage input selection is automatic. The control senses the line input voltage and then operates the pool pump at the applied input voltage. No action is required.
3. Remove the conduit plug on the side of the High Voltage Compartment.

## Power Defender 165 & 270 for Waterway

4. Insert the power cable and use a water tight connector to seal the conduit hole (1/2-14 NPT thread).
5. Install the **AC** and **Ground** power input wires as specified on the motor nameplate. You must connect **L1**, **L2**, and **GND** (Green Screw) in the wiring compartment correctly and securely (Figure 2).



**Figure 2 – AC Input Terminal Block**

6. Set the User Interface Cover back in place and secure it tightly with the four (4) hex screws.
7. Apply electrical power. You can now begin programming the pump.

## Wiring the Auxiliary Load Relay (optional)

The Auxiliary Load Relay automatically closes when the motor is operating at 2100 RPM so that you can activate an external pool accessory that is dependent on a specific flow rate, e.g., a booster pump, chlorine generator, or cleaner, etc.

### 1.65 THP Dual Voltage Model Only

There are two voltage options when operating the 1.65 THP pool pump motor. In this case, the motor can operate on either 115 or 230 Vac. The voltage input selection is automatic. The control senses the line input voltage and then operates the pool pump at the applied input voltage.

The wiring schematic for the Auxiliary Load Relay on the 1.65 THP Dual Voltage Model is as follows.

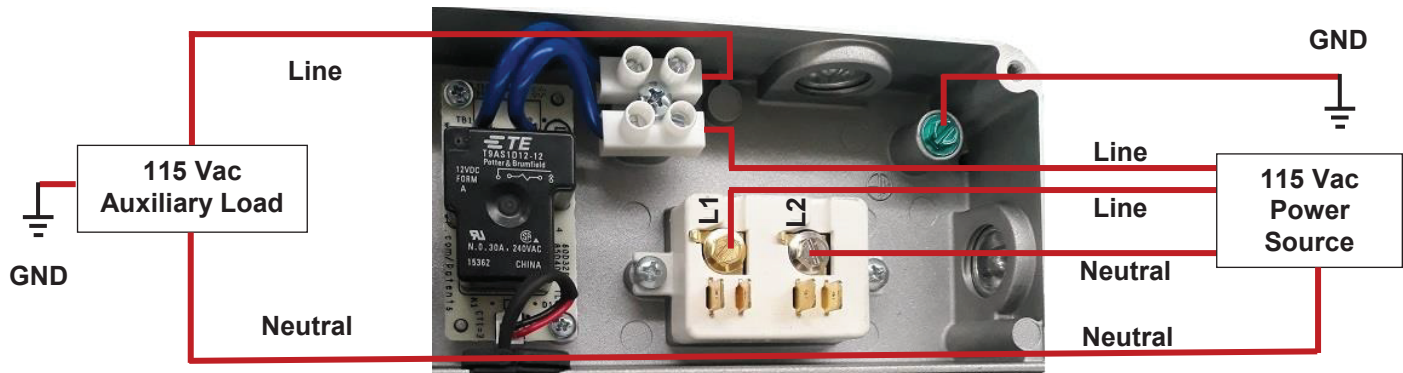

Figure 3 – Auxiliary Load Relay Wiring, 115 Vac Power

### 1.65 THP Dual Voltage Model, 2.7 THP Single Voltage Model

There are two voltage options when operating the 1.65 THP pool pump motor. In this case, the motor can operate on either 115 or 230 Vac. The voltage input selection is automatic. The control senses the line input voltage and then operates the pool pump at the applied input voltage.

Operating the motor at 2.7 THP requires 230 Vac electrical power. The voltage input selection is automatic. The wiring schematic for the Auxiliary Load Relay is as follows.

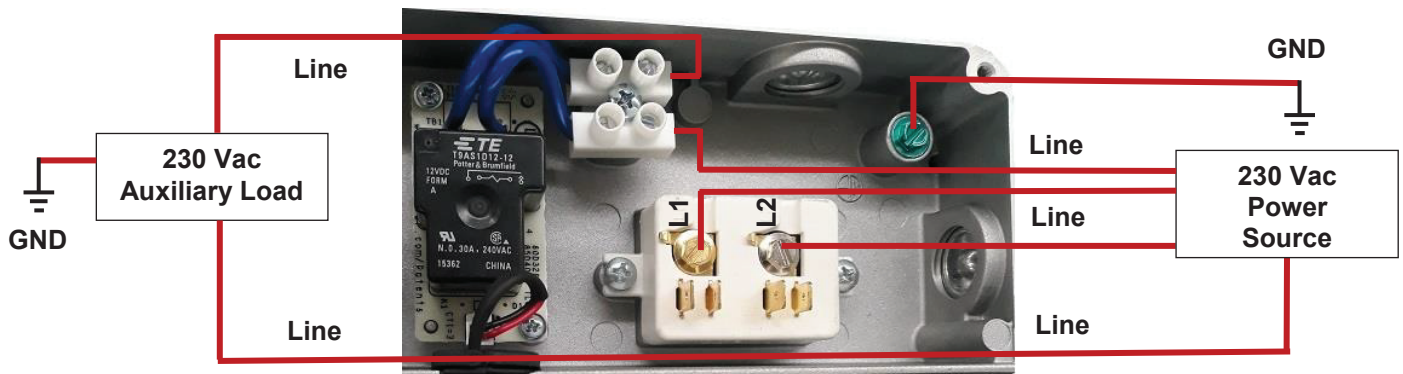

Figure 4 – Auxiliary Load Relay Wiring, 230 Vac Power

## Protections

The unit is designed to protect itself in the event of a fault situation. Fault handling is defined below:

- The control unit disables power to the motor. (The motor will coast to a stop.)
- If the fault condition clears, the control attempts to restart automatically. For example, if an over-temp fault occurs, the control does not attempt to restart the motor until the temperature drops below the fault threshold.
- The control cycles through the number of retries associated with the given fault condition.

### Control Unit Temperature

Motor output power is reduced until the control unit temperature returns to normal operating parameters. If the motor is unable to reach normal operating temperature by reducing output power, the motor turns off. If the condition clears, the motor automatically restarts.

### Low Input Line Voltage

The control turns the motor off for low voltage. When the voltage returns to acceptable operating levels the motor automatically restarts.

### Low Temperature Monitor

When the control senses the ambient temperature dropping below the threshold level (as defined by the installer/end-user), the control sends a command for the motor to run at 1200 RPM to help prevent water from freezing in the pool plumbing. Refer to the **Low Temp Monitor** setting on **page 20** for specific information covering the On/Off cycle and adjusting the temperature setting.

### Motor Stalled

When the control detects that the motor shaft cannot rotate, the pool pump motor shuts down and automatically restarts when operating conditions are within specifications.

### Open Output Phase

When one or more of the three phase lines between the motor and control is not connected well, the output voltage in the control is not able to reach the motor. The motor cycles through the shutdown/restart sequence several times to correct the fault condition. If that is unsuccessful, the motor stops.

### Output Over Current

Motor output power is reduced until the current returns to normal operating parameters. If the motor is unable to reach normal operating current by reducing output power, the motor turns off. If the condition clears, the motor automatically restarts.

### Output Over Power

The control monitors shaft output power continuously using estimated speed and torque produced by the motor shaft. The control limits the torque of the motor to maintain shaft output power below or equal to the maximum power limit. If the overload condition reduces the speed beyond the designed operating range, the motor stops.

## Hardware Protection

### Fuse Protection

The unit includes fuse protection to meet UL® component failure testing. Fuses are not user-serviceable and are intended to last the life of the product.

### Inrush Protection

The inverter limits inrush current to less than 150A peak surge. The duration is less than 5ms.

## Mechanical Requirements

### Connections

Input power and control signals are via conduit connections. There are two compartments: See Figure 1 on page 8.

- High Voltage input power
- Low Voltage control inputs

The High Voltage Compartment is supplied with a threaded hole for 1/2" NPT conduit connection for use with the required, sealed conduit connector and screw terminals appropriate for the voltage and current present. The terminals accommodate #12 – #14 AWG wire-size for electrical power.

## Environmental Requirements

### Environmental Ranges

The motor is designed for indoor or outdoor use with temperatures in the following ranges.

Type	Range
Full Shaft Output Power	39° F to 122° F (4° C to 50° C)
Storage Temperature Range	-67° F to 203° F (-55° C to 95° C)
Humidity	0-99.5% RH (condensing)

### Environmental/Ingress Protection

IPX5 rating







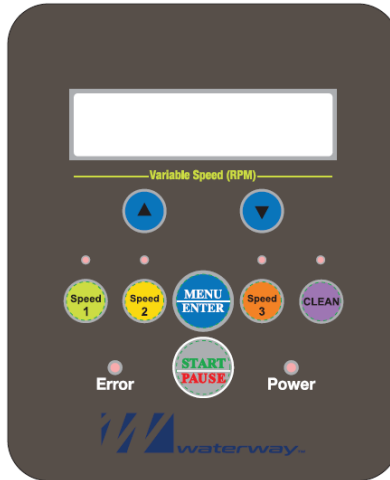





## Pump Control via the User Interface

The User Interface (UI) enables you to program the operation of the pool pump motor. Generally, the buttons have two functions. **Navigation Mode** allows you to move back and forth between the different settings. **Input Mode** allows you to customize the settings and confirm your selections.



### Navigation Overview

	<b>Scroll Up</b> – In <b>Navigation Mode</b> , scroll up to the previous screen. In <b>Input Mode</b> , increase the value of the digit in the LCD display.
	<b>Scroll Down</b> – In <b>Navigation Mode</b> , scroll down to the next screen. In <b>Input Mode</b> , decrease the value of the digit in the LCD display.
	<b>Speed 1</b> – In <b>Navigation Mode</b> , there is no response. Likewise, in <b>Input Mode</b> , there is no response. In <b>Run Mode</b> , force an override using the pre-assigned <b>Speed 1</b> default RPM.
	<b>Speed 2</b> – In <b>Navigation Mode</b> , there is no response. Likewise, in <b>Input Mode</b> , there is no response. In <b>Run Mode</b> , force an override using the pre-assigned <b>Speed 2</b> default RPM.
	<b>MENU/ENTER</b> – When the menus are unlocked, in <b>Navigation Mode</b> , enter a sub level menu or move to <b>Input Mode</b> . In <b>Input Mode</b> , confirm the latest setup and moves back to <b>Navigation Mode</b> .
	<b>Speed 3</b> – In <b>Navigation Mode</b> , there is no response. Likewise, in <b>Input Mode</b> , there is no response. In <b>Run Mode</b> , force an override using the pre-assigned <b>Speed 3</b> default RPM.
	<b>CLEAN</b> – Pressing this button starts a 30-minute manual cleaning cycle at maximum speed, 3450 RPM (100% flow).
	<b>START/PAUSE</b> – In <b>Navigation Mode</b> , exit a menu and enter <b>Standby Mode</b> , or return to <b>Navigation Mode</b> from a sub menu. In <b>Input Mode</b> , exit a menu screen and return to <b>Navigation Mode</b> . In <b>Run Mode</b> , pause the motor.
	<b>Error</b> – A flashing red light indicates the motor encountered an error. Refer to the <b>Fault Conditions</b> section of the manual on <b>page 29</b> for additional information.
	<b>Power</b> – A solid green light indicates the motor is powered on and working (running Timer cycles). A flashing green light indicates the motor has power, but is paused (not allowed to run).









**Note:** For definitions of the different **Operational States**, see **page 16**.

## Quick Start Guide













The Power Defender 165 & 270 for Waterway ships with a Quick Start Guide on the inside cover of the User Interface. If the guide is missing, use the following.

### QUICK START GUIDE

**Set Time of Day:**

1. Press  to view the settings menu and press  again to enter the Standard Settings menu.
2. Press  on the Time of Day screen to edit the hour.
3. Adjust flashing value with  or .
- Press  to confirm new hour then change minutes and AM/PM in the same way.
4. Press  to save settings and return to Time of Day screen.
5. Return to the Standard Settings menu by pressing .
6. If a custom flow schedule is not desired, press  twice to exit the settings menu and return to normal operation mode.

**Set Daily Run Schedule:**

1. Press  to view the settings menu.
2. Press  or  to select Custom Settings menu and  enter.
3. Use  or  to navigate the Timer 1-7 and press  to edit the displayed Timer value.
4. Adjust the flashing value with  or  and press  to confirm and adjust the next value.
5. Repeat Steps 3 and 4 until all desired Timers, Durations, and Speeds are set.  
(Note: Setting the Duration to 0 deactivates the Timer).
6. Return to the Custom Settings menu by pressing .
7. Press  twice to return to normal operation mode.

Installer Information

Scan QR code  
for full manuals.





## Navigation with UI Buttons

When the motor is in **Standby Mode** and the menus are unlocked, pressing the **MENU/ENTER** button once cycles the motor into **Navigation Mode**. You cannot change settings while in **Navigation mode**. You can only view the setting and cycle through the menus.

## Cleaning and Override Operations

The clean operation always runs at 3450 RPM for 30 minutes. Pressing a **Speed** button cancels the clean and the timer associated with it. The motor then shifts to the speed associated with the **Speed** button. In **Run Mode** or **Standby Mode**, the three **Speed** buttons and **Clean** execute as follows:

Button	Description
Speed 1 <sup>a</sup>	Force an override speed of 1350 RPM.
Speed 2 <sup>a</sup>	Force an override speed of 1725 RPM.
Speed 3 <sup>a</sup>	Force an override speed of 2760 RPM.
Clean <sup>b</sup>	Start a 30-minute cleaning cycle at a speed of 3450 RPM (100% flow).

<sup>a</sup>You can adjust the RPM in a pre-configured override. Press the **Scroll Up** or **Scroll Down** button to increase or decrease the RPM in increments of 10. Press and hold either button for 2 seconds to increase or decrease RPM in increments of 100.

<sup>b</sup>If **Speed x** is pressed while cleaning, the **Clean** operation and the **Clean Timer** are canceled. If **Clean** is pressed again while cleaning, the **Clean Timer** will be reset to 30 minutes to extend the cleaning time.

**Example:** After pressing a **Speed** button, the motor continues to run until the next timed flow is set to run, which potentially could be several hours. If you press **Clean**, the motor runs for 30 minutes and shuts off. However, if you press **Clean**, run the cycle for a short time (e.g., 5 minutes), and then press a **Speed** button, the clean cycle is canceled and the motor changes to the speed associated with the **Speed** button. Depending on the start time of the next timed flow, the motor may run for more than or less than 30 minutes.

**Note:** Priming during a cleaning cycle is bypassed when the **Cleaning Speed** is greater than or equal to the default **Priming Speed** of the pool pump motor. Refer to the **Priming Duration** and **Priming Speed** settings on **page 19**.

In **Run Mode** or **Standby Mode**, pressing **START/PAUSE** pauses the motor and cancels the override. Press **START/PAUSE** again to run the motor at the scheduled speed, which could be **Off**.

## Locking Menus

You can lock the menus to prevent unintended changes in settings or schedules. With the motor in **Standby Mode**, press the **MENU/ENTER** button and hold the button down for three (3) seconds. The LCD screen flashes and displays the following message for ten (10) seconds. **Note:** If the control does not detect a button press in the time frame, the request to lock the keypad is cancelled.

Press Enter Key  
To Lock Menus

## Power Defender 165 & 270 for Waterway

Press the **MENU/ENTER** button within the time frame to confirm the operation. The LCD screen then displays the following message for two (2) seconds and returns to normal operation. With the menus locked, the UI displays the following message anytime the **MENU/ENTER** button is pressed.



Menus Locked

### Unlocking Menus

With the motor in **Standby Mode**, press the **MENU/ENTER** button and hold the button down for three (3) seconds. The LCD screen flashes and displays the following message for ten (10) seconds.

**Note:** If the control does not detect a button press within the time frame, the request to unlock the keypad is cancelled.



Press Enter Key  
To Unlock Menus

Press the **MENU/ENTER** button again to confirm the operation. The LCD screen displays the following message for two (2) seconds and then returns to normal operation.



Menus Unlocked

### Operational States

The table below describes the operational states of the motor.

State	Description
Fault	The pool pump motor moves into this state in response to the detection of a fault condition in either the motor or the control.
Navigation	Pressing the <b>MENU/ENTER</b> button while in Standby shifts the motor to the Navigation state in which the motor can be configured.
Pause	The control is waiting for <b>Start/Pause</b> to unpause. Scheduled events will not run in Pause state.
Power Loss	If the control detects a low voltage condition, it prepares the motor for a possible power loss.
Power On	Initialize the motor and all communication ports. The motor is ready to run.
Remote	The pump is operating under commands it receives from a central controller. The UI is bypassed in this operational state.
Run	The pump is running in response to a timer, a manual override, a manual pool cleaning, or a low temperature event.
Standby	The pump is not paused and there is no timed flow scheduled at the moment.

# Power Defender 165 & 270 for Waterway

## Menu Trees

There are two top-level menus in **Navigation Mode: Standard Settings** and **Custom Settings**. Sub menus under these two allow you to change system settings and customize all program timers. The menu trees for each are outlined on the next two pages.



## Standard Settings

Options under **Standard Settings** allow you to set the time on your motor, set temperature readings to Celsius or Fahrenheit, priming duration and speed, low temperature monitoring and threshold, remoting system monitoring, or reset configurations to default values. The following is a map of the menu tree. **Note:** By default, some menu options are not available unless the associated menu option is enabled.

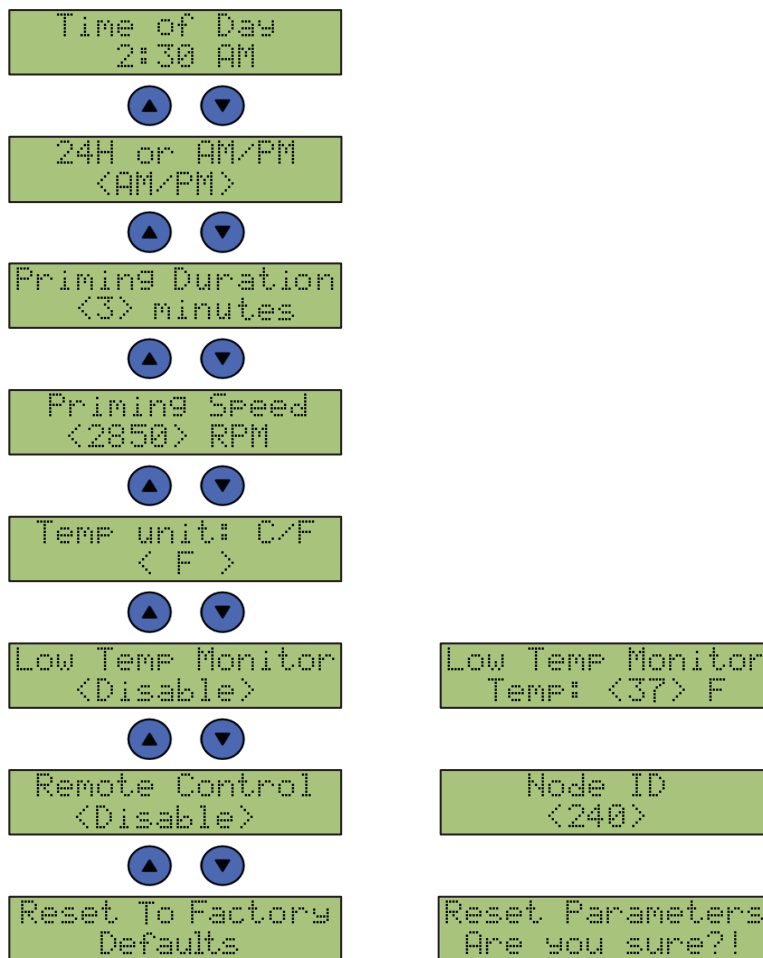

# Power Defender 165 & 270 for Waterway

## Custom Settings

Configuration options under **Custom Settings** allow you to program the **Start Time**, **Duration**, and **Speed** of each Timer. You can program up to seven. The following is a map of the menu tree.

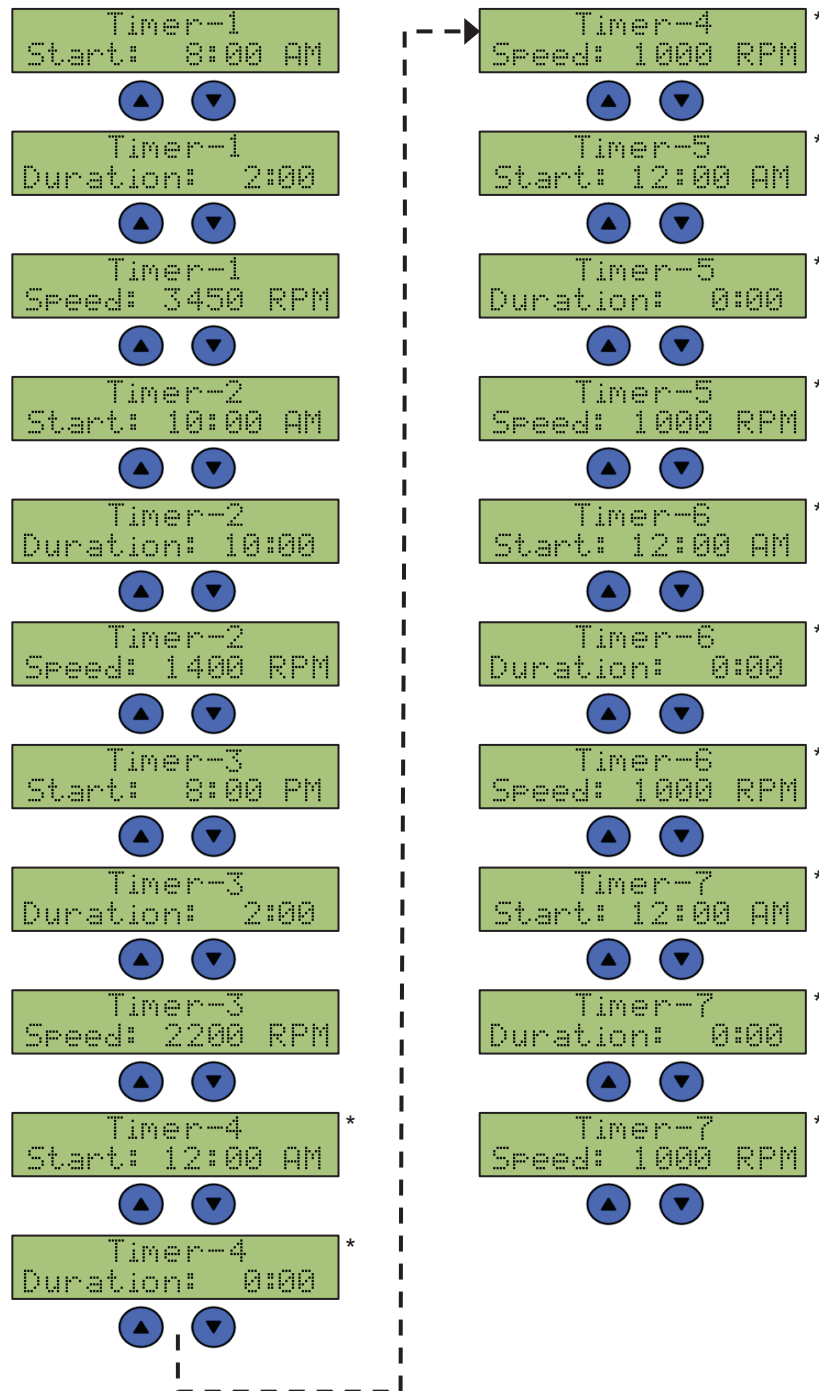

\*By default, Timers 4 – 7 are deactivated. Setting a **Duration** of 0 deactivates the Timer.

## Configure Your Pool Pump Motor

Begin programming the pool pump motor from the **Standard Settings** menu. The control compares the time of day you enter against programmed schedule times to determine the next pump operation.

### Time of Day

**Timers 1-7** (if all are activated) are keyed to this setting.

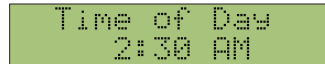

Time of Day  
2:30 AM

Press the **MENU/ENTER** button once to enter **Navigation Mode**. Press **Scroll Up** or **Scroll Down** to select the **Standard Settings** menu tree. Press **MENU/ENTER** to enter the menu tree. Press **MENU/ENTER** again to enter **Input Mode**. Press **Scroll Up** or **Scroll Down** to adjust the field blinking in the LCD display. Press **MENU/ENTER** to cycle the edit field to the right. Press **Scroll Up** or **Scroll Down** to increase or decrease the hours, minutes, and adjust the AM/PM field. Press **MENU/ENTER** to save the changes. Press **START/PAUSE** to exit the menu option and return to the menu tree in **Navigation Mode**. Press **START/PAUSE** again to return to normal operations.

### 24H or AM/PM

You can configure the pump to display time in a 24-hour clock format or 12-hour AM/PM format.

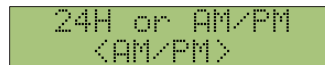

24H or AM/PM  
<AM/PM>

Press the **MENU/ENTER** button once to enter **Navigation Mode**. Press **Scroll Up** or **Scroll Down** to select the **Standard Settings** menu tree. Press **MENU/ENTER** to enter the menu tree. Press **Scroll Down** until you reach the 24H or AM/PM screen. Press **MENU/ENTER** again to enter **Input Mode**. Press **Scroll Up** or **Scroll Down** to toggle the selection. Press **MENU/ENTER** to save the changes. Press **START/PAUSE** to exit the menu option and return to the menu tree in **Navigation Mode**. Press **START/PAUSE** again to return to normal operations.

### Priming Duration

Pump priming functionality sets the duration time for the priming stage. The default time is three (3) minutes. Priming Duration range is from 0 to 9 minutes. A setting of zero (0) disables priming.



Priming Duration  
<3> minutes

Press the **MENU/ENTER** button once to enter **Navigation Mode**. Press **Scroll Up** or **Scroll Down** to select the **Standard Settings** menu tree. Press **MENU/ENTER** to enter the menu tree. Press **Scroll Down** until you reach the Priming Duration screen. Press **MENU/ENTER** again to enter **Input Mode**. Press **Scroll Up** or **Scroll Down** to increase or decrease the duration minutes. Press **MENU/ENTER** to save the changes. Press **START/PAUSE** to exit the menu option and return to the menu tree in **Navigation Mode**. Press **START/PAUSE** again to return to normal operations.

### Priming Speed

Anytime the motor is started after it has been off and is not running, the control primes the pump first by running at a designated speed for the duration indicated in the Priming Duration setting. By default, the priming speed is 2850 RPM.



Priming Speed  
<2850> RPM

Press the **MENU/ENTER** button once to enter **Navigation Mode**. Press **Scroll Up** or **Scroll Down** to select the **Standard Settings** menu tree. Press **MENU/ENTER** to enter the menu tree. Press **Scroll Down** until you reach the Priming Speed screen. Press **MENU/ENTER** again to enter **Input Mode**.

## Power Defender 165 & 270 for Waterway

Each press of the **Scroll Up** or **Scroll Down** button increases or decreases the RPM in increments of ten (10). Press and hold the **Scroll Up** or **Scroll Down** button for two (2) seconds to increase or decrease the RPM in increments of 100. Press **MENU/ENTER** to save the changes. Press **START/PAUSE** to exit the menu option and return to the menu tree in **Navigation Mode**. Press **START/PAUSE** again to return to normal operations.

**Note:** You cannot increase **Priming Speed** beyond the maximum allowable RPM rating for the motor, or decrease the **Priming Speed** below the minimum allowable rating.

### Temp Unit

You can configure the pump to display temperature readings in Fahrenheit or Celsius.



```
Temp unit: C/F
< F >
```

Press the **MENU/ENTER** button once to enter **Navigation Mode**. Press **Scroll Up** or **Scroll Down** to select the **Standard Settings** menu tree. Press **MENU/ENTER** to enter the menu tree. Press **Scroll Down** until you reach the Temp Unit screen. Press **MENU/ENTER** again to enter **Input Mode**. Press **Scroll Up** or **Scroll Down** to toggle the temperature format. Press **MENU/ENTER** to save the changes. Press **START/PAUSE** to exit the menu option and return to the menu tree in **Navigation Mode**. Press **START/PAUSE** again to return to normal operations.

### Low Temp Monitor

The control monitors the ambient temperature of the pump. If the temperature falls below a specified threshold, the pump begins cycling on and off to keep water from freezing in the pump.

If the pump is not currently running, the pump switches on for 30 minutes at approximately 30% of the rated speed of the motor. The pump then idles for 30 minutes. If at the end of 30 minutes the temperature is still below the low temperature threshold, the cycle repeats itself. By default, this feature is disabled.



```
Low Temp Monitor
<Disable>
```

Press the **MENU/ENTER** button once to enter **Navigation Mode**. Press **Scroll Up** or **Scroll Down** to select the **Standard Settings** menu tree. Press **MENU/ENTER** to enter the menu tree. Press **Scroll Down** until you reach the Low Temp Monitor screen. Press **MENU/ENTER** again to enter **Input Mode**. Press **Scroll Up** or **Scroll Down** to toggle the setting. Press **MENU/ENTER** to save the changes. Press **START/PAUSE** to exit the menu option and return to the menu tree in **Navigation Mode**. Press **START/PAUSE** again to return to normal operations.

### Low Temp Monitor

The Low Temp Monitor threshold is configurable between a range of 32° F to 50° F (0° C to 10° C).

**Note:** This option is not available unless you **Enable** the Low Temp Monitor setting above.

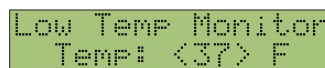

```
Low Temp Monitor
Temp: <37> F
```

Press the **MENU/ENTER** button once to enter **Navigation Mode**. Press **Scroll Up** or **Scroll Down** to select the **Standard Settings** menu tree. Press **MENU/ENTER** to enter the menu tree. Press **Scroll Down** until you reach the Low Temp Monitor threshold screen. Press **MENU/ENTER** again to enter **Input Mode**. Press **Scroll Up** to increase the digit or **Scroll Down** to decrease the digit. Press **MENU/ENTER** to save the changes. Press **START/PAUSE** to exit the menu option and return to the menu tree in **Navigation Mode**. Press **START/PAUSE** again to return to normal operations.

## Remote Control

The RS-485 port allows you to connect an external controller. When connected, the UI no longer controls the motor. Commands from the external controller take priority. Other than enabling or disabling Remote Control and possibly the Node ID, the UI plays no role in communication.

Contact US Motors/Nidec Motor Corporation for the proper communication protocol. If an external controller is used, make sure the line is an isolated, non-grounded connection.



```
Remote Control
<Disable>
```

Press the **MENU/ENTER** button once to enter **Navigation Mode**. Press **Scroll Up** or **Scroll Down** to select the **Standard Settings** menu tree. Press **MENU/ENTER** to enter the menu tree. Press **Scroll Down** until you reach the Remote Control screen. Press **MENU/ENTER** again to enter **Input Mode**. Press **Scroll Up** or **Scroll Down** to toggle the setting. Press **MENU/ENTER** to save the changes. Press **START/PAUSE** to exit the menu option and return to the menu tree in **Navigation Mode**. After exiting the menu tree, the control enters remote mode automatically. In this case, it does not return to normal operation.

If **Remote Mode** is enabled and you want to return control of the pump to the UI, follow these steps.

1. Press the **Speed 2** and **Speed 3** buttons simultaneously and hold them down for five seconds. **Note:** If a button press is not detected in ten (10) seconds, the UI reverts to **Remote Mode**.



```
Quit Remote Mode
Are You Sure?!
```

2. Press **MENU/ENTER** to save the changes and return to **Navigation Mode**.

After confirming the change, the pump stops, if it is running, and initially moves to **Standby Mode**. The pump will no longer respond to commands from the external control system. If a programmed flow is scheduled to run at this time, it will restart the motor at the programmed flow speed. Otherwise, it will remain in **Standby Mode**. Other options, for example timed flow programming, can be accessed.

## Node ID

**Node ID** sets the Modbus address that is used to communicate with the motor in **Remote Mode**. The **Node ID** can be set to any number between 1 and 247. The default number is 240.



```
Node ID
<240>
```

**Note:** This option is not available unless the Remote Control setting above is Enabled.

## Reset To Factory

This setting allows you to reset all parameters in the **Standard Settings** and **Custom Settings** menus back to the factory default settings. Refer to **page 34** for a list of the default parameters.



```
Reset To Factory Defaults
Reset Parameters
Are You Sure?!
```

Press the **MENU/ENTER** button once to enter **Navigation Mode**. Press **Scroll Up** or **Scroll Down** to select the **Standard Settings** menu tree. Press **Scroll Down** until you reach the Reset To Factory screen. Press **MENU/ENTER** again to enter **Input Mode**. The Reset Parameters screen appears. "Are you sure?!" flashes on the second line. Press **MENU/ENTER** to confirm the choice and save the changes. Press **START/PAUSE** to exit the menu option and return to the menu tree in **Navigation Mode**. Press **START/PAUSE** again to return to normal operations.



# Power Defender 165 & 270 for Waterway

## Timers 1 – 7

One of the key advantages of the Power Defender 165 & 270 for Waterway is the flexibility of customizing up to seven timers. The timers control when the pump switches on and off throughout the day. You can customize the **Start Time**, **Duration**, and **Speed** for each. Control logic begins at the speed with the earliest start time of the day and continues running that speed until the next start time of day is reached. If the timer schedule is configured in such a way that run times overlap, the timers run in priority from Timer 1 (highest) through Timer 7 (lowest). The default schedule is:

Timer #	Start Time	Duration	Speed
Timer 1	8:00 AM	2 Hours	3450 RPM
Timer 2	10:00 AM	10 Hours	1400 RPM
Timer 3	8:00 PM	2 Hours	2200 RPM
Timer 4*	12:00 AM	0 Hours	1000 RPM
Timer 5*	12:00 AM	0 Hours	1000 RPM
Timer 6*	12:00 AM	0 Hours	1000 RPM
Timer 7*	12:00 AM	0 Hours	1000 RPM

\*By default, Timers 4 – 7 are deactivated. A **Duration** of **0** deactivates a Timer.

To program a Timer, press the **MENU/ENTER** button once to enter **Navigation Mode**. Press **Scroll Up** or **Scroll Down** to select the **Custom Settings** menu tree. Press **MENU/ENTER** to enter the menu tree. Press **Scroll Down** until you reach the Timer you want to program. Press **MENU/ENTER** again to enter **Input Mode**. The following example uses **Timer 1**. The process is the same for each.

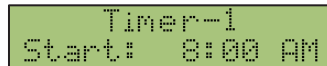

Timer-1  
Start: 8:00 AM

On the Timer Start screen, press the **MENU/ENTER** button to enter **Input Mode**. Press **Scroll Up** to increase the hour or **Scroll Down** to decrease the hour. Press **MENU/ENTER** to cycle the edit field to the right. Press **Scroll Up** to increase the minutes or **Scroll Down** to decrease the minutes. **Note:** For AM/PM time, there is a third step after setting minutes. Press **Scroll Up** or **Scroll Down** to select AM or PM.

Press **MENU/ENTER** to save the changes. Press **START/PAUSE** to exit the menu option and return to the menu tree in **Navigation Mode**. Press **START/PAUSE** again to return to normal operations.



Timer-1  
Duration: 2:00

Press **Scroll Down** until you reach the screen for the Timer Duration. Press the **MENU/ENTER** button to enter **Input Mode**. Press **Scroll Up** to increase the hour or **Scroll Down** to decrease the hour. Press **MENU/ENTER** to cycle the edit field to right. Press **Scroll Up** to increase the minutes or **Scroll Down** to decrease the minutes. Press **MENU/ENTER** to save the changes. Press **START/PAUSE** to exit the menu option and return to the menu tree in **Navigation Mode**. Press **START/PAUSE** again to return to normal operations.

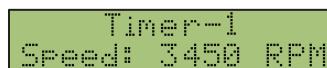

Timer-1  
Speed: 3450 RPM

Press **Scroll Down** until you reach the Timer Speed screen. Press the **MENU/ENTER** button to enter **Input Mode**. Each press of the **Scroll Up** button increases the RPM in increments of 10. Likewise, each press of the **Scroll Down** button decreases the RPM in increments of 10. Press and hold the **Scroll Up** button continuously increases the RPM in increments of 100. Press and hold the **Scroll Down** button continuously decreases the RPM in increments of 100. Press **MENU/ENTER** to save the changes. Press **START/PAUSE** to exit the menu option and return to the menu tree in **Navigation Mode**. Press **START/PAUSE** again to return to normal operations.



## Overriding a Timer

You can override the speed and flow rate programmed into **Timers 1 – 7** (if all timers are activated) without having to re-program the pump. Simply press one of the **Speed** buttons. Here is the pre-programmed speed and flow rate for each.

Button	Description
Speed 1	Force an override speed of 1350 RPM.
Speed 2	Force an override speed of 1725 RPM.
Speed 3	Force an override speed of 2760 RPM.

You can also adjust the RPM within the override. Press the **Scroll Up** or **Scroll Down** button to increase or decrease the RPM in increments of 10. Press and hold either button for 2 seconds to increase or decrease RPM in increments of 100.

The effect of the button press depends on whether the pump is currently running a Timer or standing by to execute the next Timer on the schedule.

### With the Pump in Run Mode

When the pump is running a Timer, pressing the **Speed 1**, **Speed 2**, or **Speed 3** button forces an override of the Timer currently under way. The motor begins running at the pre-programmed RPM assigned to the button for the remaining duration of the flow.

**Note:** Pressing the **START/PAUSE** button will pause the motor.

### With the Pump in Pause Mode

Under normal operating conditions, you must press **Start/Pause** again to un-pause the motor.

### With the Pump in Standby Mode

When the motor is in Standby Mode, pressing **Speed 1**, **Speed 2**, or **Speed 3** enables a Quick Start. In this case, the motor runs at the RPM assigned to the speed button until the **START/PAUSE** button is pressed.

**Note:** Pressing the **START/PAUSE** button pauses the motor.

## Pump Control via the Drive Interface Board

The Drive Interface (DI) Board is powered by an isolated low voltage (+12 Vdc) power supply. The DI Board supports the following customer inputs, in addition to the User Interface:

- MODBUS RS-485 Port
- Four (4) Discrete Switch Inputs

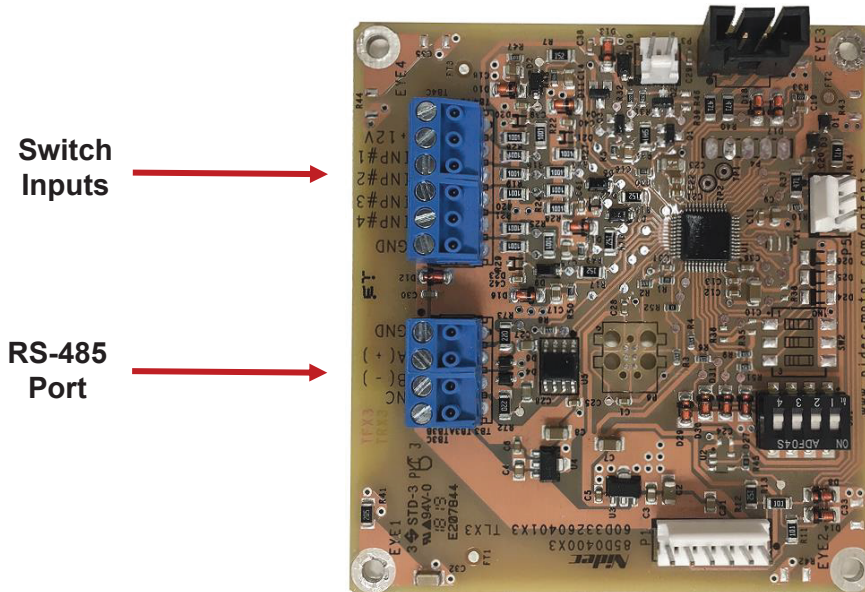

### Discrete Switch Inputs

The DI Board uses a pre-set hierarchy for establishing which input has priority.

- Switch Inputs (with INP # 4 having the highest priority)
- User Interface (lowest priority)

Switch closures on the discrete inputs operate the motor at pre-defined speeds shown in the table below. Switches may be sourced from the +12V terminal, or an external DC supply can be used. When using an external supply, make sure to complete the circuit by connecting the GND terminal to the external supply's ground.

Discrete Input	RPM
INP # 4	3450
INP # 3	2760
INP # 2	1725
INP # 1	1350

# Power Defender 165 & 270 for Waterway

## Terminals and Function



Terminal	Function
TB4-6	GND
TB4-5	INP #4
TB4-4	INP #3
TB4-3	INP #2
TB4-2	INP #1
TB4-1	+12V

## RS-485 Port

The RS-485 port allows you to connect an external controller. When connected, the UI no longer controls the motor. Commands from the external controller take priority. Other than enabling or disabling Remote Control and possibly the Node ID, the UI plays no role in communication. Contact Nidec Motor Corporation for the proper communication protocol. If an external controller is used, make sure the line is an isolated, non-grounded connection.

## Terminals and Function



Terminal	Function
TB3-4	NO CONNECT
TB3-3	B (MODBUS)
TB3-2	A (MODBUS)
TB3-1	GND (MODBUS)

## Wiring a Remote Connection

You can attach any RS485-compatible cable to the RS485 connector.

RS485  
Connector

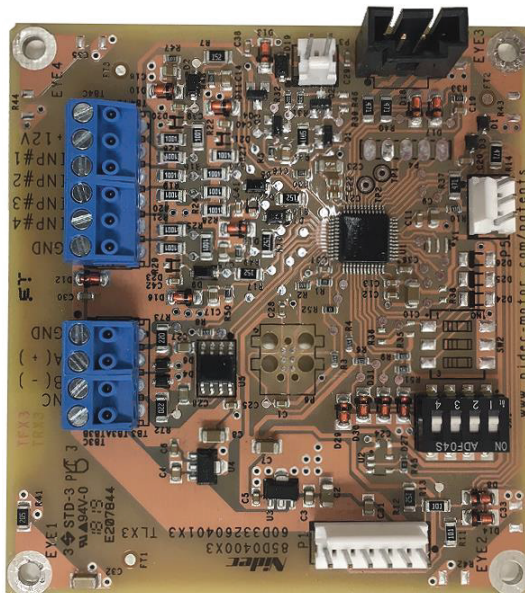

## Power Defender 165 & 270 for Waterway

Follow these steps to wire a remote connection:

1. Remove the four (4) slotted head hex washer screws securing the User Interface Cover. Set the cover aside.
2. Remove the conduit plug and feed the RS485 cable (not supplied) through the compartment. Use a water tight connector to seal the conduit hole (1/2-14 NPT thread).

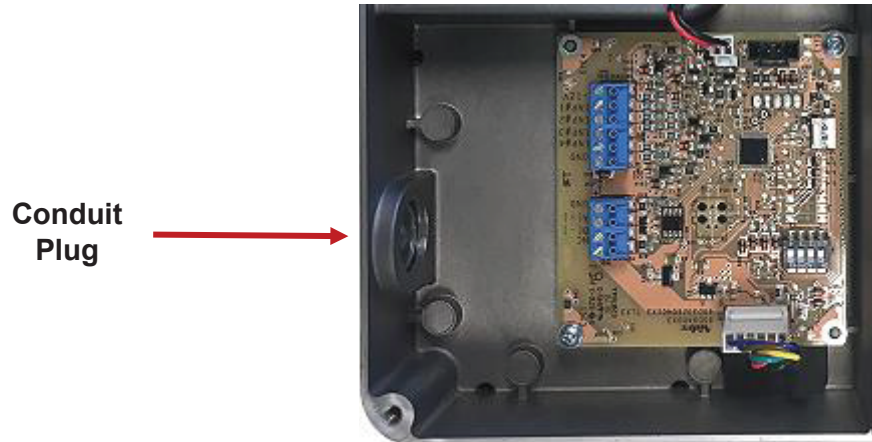

3. Attach the cable on the RS485 Connector to the **B (-)**, **A (+)**, and **GND** terminals on the DI Board.

## Troubleshooting

This troubleshooting guide provides field technicians a step-by-step process for accurately diagnosing and troubleshooting certain problems experienced by the motor.

This section however does not override or replace instructions suggested by the manufacturer of the pump system. To prevent misdiagnosis and unneeded repairs, operators should try the steps listed in the Basic Troubleshooting section first. If a problem still exists or there is an ongoing issue after following the steps in the **Basic Troubleshooting** section, then move to the **General Troubleshooting** section for further guidance.



Installation, operation, and maintenance must be performed by qualified personnel. Familiarization with and adherence to the National Electrical Code (NEC), National Fire Protection Association (NFPA) standards, and to local codes are required. It is important to observe safety precautions to protect personnel from possible injury.

- Code requirements differ from state to state. Install equipment using qualified electricians in accordance with the applicable codes and ordinances in your area and in accordance with the NEC. All electrical connections should be made and maintained by a qualified or licensed electrician.
- Always disconnect electrical power at the fuse box or circuit breaker panel before handling electrical connections or performing maintenance on this unit. Allow the motor to come to a complete stop and wait four (4) minutes. This allows the capacitors to discharge any residual voltage.



- Wear safety glasses to inspect the equipment while it is running or while working on equipment.

## Basic Troubleshooting

### Motor shaft is not rotating or runs abnormally

- Verify that the pump should be running, based on the time of day and how you have the sequence of timers programmed in the pump.
- Check the circuit breaker for trips or accidental shutoff.
- Verify that the signal cable and electrical power leads are securely connected to the control connectors. Inspect for shorts, detached wiring, or loose connections.

### Motor rattles or makes excessive noise

- Inspect the motor for accumulated dirt and debris, or other signs of damage.
- Inspect the motor for secure mounting to the system chassis.
- Inspect the screws on the User Interface Cover. Verify that they are securely tightened.
- Inspect the shaft; verify that the shaft is not bent and that the motor shaft spins freely in both directions.

## General Troubleshooting

Symptom	Possible Cause	Corrective Action
Motor fails to start.	Incorrect voltage to the motor	Verify that the motor voltage to the terminals matches the nameplate voltage requirements.
	Improper terminal connections	Turn <b>OFF</b> power. Verify that connections are per the terminal connection section of this manual.
Motor stalls during operation.	Overloaded motor	With electrical power disconnected, verify that the pump rotates freely.
	Low voltage	Verify that the motor voltage under load to the conduit box connection terminals matches the nameplate voltage requirements.
	Breaker trip	The interruption of power due to a current breaker trip indicates a current overload to the circuit beyond the rating of the breaker(s). Use a qualified electrician to make sure the breaker(s) rating is properly sized to the motor current rating based on the National Electrical Code.
Motor vibrates or is excessively noisy.	Pump	Before taking any corrective actions, ensure that the electrical power is <b>OFF</b> . Check the pump to ensure it is properly connected to the motor shaft. Check the pump impeller for damage. Make sure there are no foreign objects inside pump.
	Motor base (if applicable)	Verify that the motor base (if applicable) is not cracked and that the four mounting bolts are tightened securely.
Motor is not operating properly.	Electrical power	Check line voltage.
Motor does not start	Over / under voltage	Check line voltage.



## Fault Conditions

The motor is designed to protect itself in the event of a fault condition. Should the motor encounter a fault, the Error light on the integrated UI illuminates and the LCD displays basic information on the error.

### E 0 – Motor Control Overcurrent (HW)

Motor phase current is the input current enabling the pump to run at or under a specified speed or torque. Phase current over the peak threshold will trigger an Overcurrent (HW) or an Overcurrent (SW) fault. The pump will shut down and restart automatically. Then, the motor will cycle through the shutdown/restart sequence several times to correct the fault condition. At the end of the sequence, if the fault has not corrected itself, the motor will not restart.

Overcurrent usually happens very quickly. In this case, the motor protects itself by shutting down immediately. The fault condition can be triggered by the motor, the control, or the pump system. The cause for either is likely a severe pump overload. There are a couple possibilities. (1) Unfiltered debris lodged in the pump needs to be removed. (2) The pump is binding and needs field service.

Press the **Start/Pause** button to clear the fault from the LCD display. Then, press any **Speed** button to restart the motor. The retry sequence will start over. If the fault continues to occur, contact your pool professional or a qualified electrician for service.

### E 1 – Motor Control Low Voltage

The voltage to the motor/control terminals must be either 115 or 230 Vac for the 1.65 THP Dual Voltage model, or 230 Vac for the 2.7 THP Single Voltage model, +/- 10 percent, 60 or 50 Hertz. A sustained input voltage significantly below the nominal voltage will cause a Low Voltage trip to occur.

When the fault occurs, the pump will shut down and automatically restart when operating conditions are within specifications.

When the input voltage returns to a normal state, the fault automatically clears and the motor restarts. If the fault continues to occur after verifying input line voltage is correct, contact your pool professional or a qualified electrician for service.

### E 2 – Motor Control High Voltage

The voltage to the motor/control terminals must be either 115 or 230 Vac for the 1.65 THP Dual Voltage model, or 230 Vac for the 2.7 THP Single Voltage model, +/- 10 percent, 60 or 50 Hertz. A sustained input voltage significantly above the nominal voltage will cause a High Voltage trip to occur.

When the fault occurs, the pump will shut down and automatically restart when operating conditions are within specifications. The pump will cycle through the shutdown/restart sequence several times to correct the fault condition.

When the input voltage drops to a normal state, the fault automatically clears and the motor restarts. If the fault continues to occur after verifying input line voltage is correct, contact your pool professional or a qualified electrician for service.

### E 4 – Motor Control Power Module Hot

The power module is an integrated circuit in the motor control. Software in the control continuously monitors the temperature of this component. If the temperature in the power module exceeds a specified threshold, the motor stops in order to prevent the power module from overheating and causing damage to the motor.

The temperature of other parts of the motor control can also be elevated during operation and the control will attempt to reduce the temperature by reducing motor output power. If the control is unable to reduce the temperature enough by decreasing the output power, this or one of several

other faults will be triggered and the motor will stop. After the system temperature returns to an acceptable level the pump will automatically restart and the fault on the LCD display will be cleared.

### E 5 – Motor Control Open Output Phase

An open phase indicates that one or more of the three phase lines between the motor and control is not connected securely, or that there is an open circuit in the motor winding phase. Output voltage in the control is not able to reach the motor. The pump cycles through the shutdown/restart sequence several times to correct the fault condition. If that is unsuccessful, the motor stops.

Press the **Start/Pause** button to clear the fault from the LCD display. The retry sequence will start over. Then, press any **Speed** button to restart the motor. If the fault continues to occur after verifying the wire connections, contact your pool professional or a qualified electrician for service.

### E 7 – Motor Control Max Output Load

Max Output Load usually happens over an extended period of time. The motor becomes torque limited and, to protect itself, the motor tries to modify its operation to correct the problem. If the motor cannot back down far enough to relieve the torque issue, the motor shuts down.

Refer to **E 0** for possible corrective actions.

### E 8 – Motor Control EE Failure

This fault indicates that an error occurred in the memory area of the chip used to store software information needed to run the motor. For some reason, the software was unable to read key values from memory.

### E 9 – Motor Control Overcurrent (SW)

This is another type of overcurrent fault, similar to **E 0**, but uses a different detection method. Refer to **E 0** for a description and possible corrective actions.

### E 11 – Motor Control Communication Lost

The motor and the system control unit (DI) are unable to communicate. When that happens, the pump shuts down.

Remove the User Interface Cover to the voltage compartments. Refer to **Step 1** in Wiring the Motor on **page 8**. Verify that the wiring connectors on the circuit board in the Low Voltage Compartment are securely fastened. Replace the User Interface Cover. Press any **Speed** button to restart the motor. If the fault continues to occur after verifying the wire connections, contact your pool professional or a qualified electrician for service.

### E 12 – UI Key Stuck

The **Start/Pause** button is stuck. If that should happen, the motor shuts down. Press the **Start/Pause** button to see if you can release it. If the fault continues to occur after verifying the wire connections, contact your pool professional or a qualified electrician for service.

### E 16 – Motor Stalled

This fault indicates that the motor shaft is unable to turn. When the software detects this condition, the motor automatically shuts down and restarts. The pump cycles through the shutdown/restart sequence several times to correct the fault condition.

If the shaft is unable to turn, it may be caused by an accumulation of dirt or debris in or around the motor causing the impeller to jam. Refer to the **Maintenance** section on **page 33** for steps you can take.

Press the **Start/Pause** button to clear the fault from the LCD display. The retry sequence will start over. Then, press any **Speed** button to restart the motor. If the fault continues to occur after a maintenance inspection, contact your pool professional or a qualified electrician for service.



### **E 17 – Control Over Temperature**

This is another type of circuitry over temperature fault, similar to **E 4**, but sourced from different part of the control. Refer to **E 4** for a description and possible corrective actions.

### **E 18 – Motor Control Hardware Fault (Opens/Shorts)**

An internal hardware failure has occurred. This fault indicates a serious problem within the control system that cannot be fixed by the end user. Contact your pool professional or a qualified electrician for service.

### **E 25 – Reset to Factory Settings**

Pool settings stored in memory became corrupted. All values were automatically reset to the factory settings. Any customized settings will have to be re-entered. This is an informational fault that is displayed only for a short time. After the message disappears from the UI, the motor/pump is ready to run using the default factory settings.

### **E 26 – Modbus Comm Lost**

While operating in remote mode, the connection to the central controller was lost.

Remove the User Interface Cover to the voltage compartments. Refer to **Step 1** in Wiring the Motor on **page 8**. Verify that the wiring connectors on the circuit board in the Low Voltage Compartment are securely fastened. Also, refer to the **RS-485 Port** on **page 25** and verify that all connections to the remote/central controller are made correctly. Replace the User Interface Cover and connect power to the motor again. Attempt to reestablish communication with the central controller. If the fault continues to occur after verifying the wire connections, contact your pool professional or a qualified electrician for service.

### **E 27 – MC Comm Lost**

This is another type of communication error between the motor and the system control unit (DI). Refer to **E 11** for a description and possible corrective actions.

### **E 29 – Limits profile in DI EE is corrupt**

These faults indicate that an error occurred in one of the memory areas of one or more of the system chips used to store motor control or user configurable parameters. For some reason, the software was unable to read the values from memory.

Power down the motor. Wait four (4) minutes. Then, power the motor up again. If the fault continues to occur after powering up the motor, contact your pool professional or a qualified electrician for service.

### **E 30 – Options profile in DI EE is corrupt**

This is another type of memory failure. Refer to **E 29** for a description and possible corrective actions.

### **E 31 – Power loss profile in DI EE is corrupt**

This is another type of memory failure. Refer to **E 29** for a description and possible corrective actions.

### **E 32 – DI Template Mismatch**

This is another type of memory failure. Refer to **E 29** for a description and possible corrective actions.

### **E 33 – UI/DI Comm Lost**

The User Interface and the system control unit (DI) are unable to communicate. **E 33** occurs if communication is properly established at power up but then lost sometime later.

Remove the User Interface Cover to the voltage compartments. Refer to **Step 1** in Wiring the Motor on **page 8**. Verify that the wiring connectors on the circuit board in the Low Voltage Compartment are securely fastened, in particular check connector **P2** on the DI Board. Replace the User Interface Cover. Press any **Speed** button to restart the motor. If the fault continues to occur after verifying the wire connections, contact your pool professional or a qualified electrician for service.

### **E 34 – No DI at Power Up**

This is another type of communication error. **E 34** can only occur when the unit is first powered up. Refer to **E 33** for a description and possible corrective actions.

## Maintenance



Before performing any maintenance on the pump, disconnect electrical power. Allow the motor to come to a complete stop and wait four (4) minutes. This allows the bus capacitors in the control to discharge any residual voltage.

- Periodically inspect the installation. Check for dirt accumulation, unusual noises or vibration, overheating, worn or loose couplings, high motor amps, poor wiring or overheated connections, loose mounting bolts or guards, and worn motor starter contacts. Check all wiring harnesses and control connectors. Inspect for shorts, detached wiring, or loose connections.
- Remove any debris accumulation, particularly in and around vent openings by vacuuming. Dirt or debris accumulation can jam the impeller, cause motor overheating, and is also a fire hazard.
- **Do not** use solvents! Some solvents may attack motor insulation, finish, or bearing lubricants. Solvents are highly flammable.
- Ball bearing motors are permanently lubricated. No maintenance is required.

## Lowering Your Utility Costs

Your electric bill is based on the number of Kilowatts used in a typical billing cycle. Each Kilowatt is 1,000 watts. To calculate how much energy your current pool motor is using and to calculate the savings potential your pool pump motor, visit our web site and use the [Pool Energy Calculator](#).

([www.usmotors.com/poolcalculator](http://www.usmotors.com/poolcalculator))

The calculator uses US Dollars (USD) for savings calculation only. The calculator will show you how many hours to run your pump each day, along with the appropriate speed for maximum energy savings. Contact your utility company to determine peak demand times of day or the times of day during which higher utility costs are charged to the customer. Then, program your motor either not to run at all, or to run at very low RPMs during these periods.

## Example Calculations

**Note:** By reducing your speed to 50% RPM, the horsepower requirement is reduced to 1/8th of the 100%. The calculation is as follows:

$$(50/100 * 50/100 * 50/100) = .125 \text{ or } 12.5\%.$$

To run the pump at 30% RPM, the calculation is as follows:

$$(30/100 * 30/100 * 30/100) = 0.027 \text{ or } 2.7\%$$

This would be 2.7% of the previously used Max THP. Lower utility cost is a primary advantage of the Power Defender 165 & 270 for Waterway. Try out the **Pool Energy Calculator** to determine your energy savings by reducing the speed while enabling the proper amount of daily flow needed to filter your pool.

## Default Settings

These are the factory default settings for each of the configurable parameters. The default values listed below are based on AM/PM equivalents, not the 24H clock setting. You can reset the pool pump motor to the default settings by enabling **Reset To Factory** located in the **Standard Settings** menu tree.

Standard Settings	Value	Units
Time of Day	-	
24H or AM/PM	AM/PM	
Priming Duration	3	Minutes
Priming Speed	2850	RPM
Temp Unit	F	
Low Temp Monitor	Disable	
Low Temp Monitor	37°	F
Remote Control	Disable	
Node ID	240	Numeric
Reset To Factory	-	

Custom Settings	Value	Units
Timer 1 Start	8:00 AM	
Timer 1 Duration	2	Hours
Timer 1 Speed	3450	RPM
Timer 2 Start	10:00 AM	
Timer 2 Duration	10	Hours
Timer 2 Speed	1400	RPM
Timer 3 Start	8:00 PM	
Timer 3 Duration	2	Hours
Timer 3 Speed	2200	RPM
Timer 4 Start*	12:00	
Timer 4 Duration*	0	Hours
Timer 4 Speed*	1000	RPM
Timer 5 Start*	12:00	
Timer 5 Duration*	0	Hours
Timer 5 Speed*	1000	RPM
Timer 6 Start*	12:00	
Timer 6 Duration*	0	Hours
Timer 6 Speed*	1000	RPM
Timer 7 Start*	12:00	
Timer 7 Duration*	0	Hours
Timer 7 Speed*	1000	RPM

\*By default, Timers 4 – 7 are deactivated. A **Duration** of **0** deactivates the Timer.

## Warranty Information

### LIMITED WARRANTY

Nidec Motor Corporation (NMC) extends the following LIMITED WARRANTY to the purchaser and to its customers (collectively referred to as the "Purchaser") of the enclosed motor and components: the motor and components are free from defects in materials and workmanship under normal use, service and maintenance FOR A PERIOD OF 18 MONTHS FROM THE DATE OF ORIGINAL PURCHASE FROM NMC OR THE NMC DEALER/RETAILER, NOT TO EXCEED 30 MONTHS FROM THE DATE OF MANUFACTURE BY NMC. THE FOREGOING WARRANTY IS THE ONLY WARRANTY GIVEN AND NO OTHER WARRANTY IS PROVIDED, EXPRESS OR IMPLIED, INCLUDING WITHOUT LIMITATION, MERCHANTABILITY OR FITNESS FOR A PARTICULAR PURPOSE. Certain aspects of disclaimers are not applicable to consumer products, i.e., motor and components acquired by individuals and used for personal, family or household purposes (as distinguished from industrial or other purposes). Some states do not allow limitations on how long an implied warranty lasts, so the above limitation may not apply to you. This warranty gives you specific legal rights, and you may have other rights which vary from state to state.

Certain repairs or services are the responsibility of the Purchaser and the Purchaser is expected to pay for them. This warranty does not extend to any losses or damages due to misuse, accident, abuse, neglect, negligence, unauthorized modification or alteration, use beyond rated capacity, or improper installation, maintenance, application or use, including, without limitation, use in a manner contrary to the accompanying instructions or applicable codes.

If within thirty (30) days after Purchaser's discovery of any warranty defects within the above stated warranty period, Purchaser notifies NMC or the dealer from whom the motor was purchased in writing, NMC shall, at its option and as Purchaser's exclusive remedy, repair or replace or refund the purchase price for that portion of the motor and components found by NMC to be defective. Failure by Purchaser to give such written notice within the applicable time period shall be deemed an absolute and unconditional waiver of Purchaser's claim for such defects. Purchaser must write or call the dealer from whom the motor was purchased for directions regarding the shipment of the motor, with freight prepaid by the Purchaser, to an authorized service location for warranty service. If Purchaser is unable to contact the dealer to obtain sufficient instructions regarding the handling of the motor, Purchaser should write NMC at the address below, giving the motor model number, the dealer's name, address and number of dealer's invoice; and describing the nature of the alleged defect. Arrangements for warranty service will then be made by NMC.

If the motor is damaged in transit, Purchaser should file a claim directly with the carrier.

IN NO EVENT, REGARDLESS OF THE FORM OF THE CLAIM OR CAUSE OF ACTION (WHETHER BASED IN CONTRACT, INFRINGEMENT, NEGLIGENCE, STRICT LIABILITY, OTHER TORT OR OTHERWISE), SHALL NIDEC'S LIABILITY TO PURCHASER OR ITS CUSTOMER EXCEED THE PRICE PAID BY PURCHASER FOR THE SPECIFIC MOTOR OR OTHER GOODS PROVIDED BY GIVING RISE TO THE CAUSE OF ACTION. IN NO EVENT SHALL NIDEC'S LIABILITY TO PURCHASER OR ITS CUSTOMER EXTEND TO INCLUDE INCIDENTAL CONSEQUENTIAL OR PUNITIVE DAMAGES. WITH RESPECT TO CONSUMER PRODUCTS, SOME STATES DO NOT ALLOW THE EXCLUSION OR LIMITATION OF INCIDENTAL OR CONSEQUENTIAL DAMAGES, SO THE ABOVE LIMITATION OR EXCLUSION MAY NOT APPLY TO YOU.

## Notes

## Notes

© 2020 Waterway Plastics, Inc. All rights reserved.  
Waterway™ is a trademark of Waterway Plastics.

**For more information**

2200 East Sturgis Road | Oxnard, California 93030

Phone: 805-981-0262

FAX: 805-981-9403

<https://waterwayplastics.com>

