



THE LEADERS IN RECREATION, FITNESS, AND ABILITY!

9889 Garrymore Ln

Missoula, MT 59808

888-687-3552 | +1-406-549-0769

www.aquacreek.com

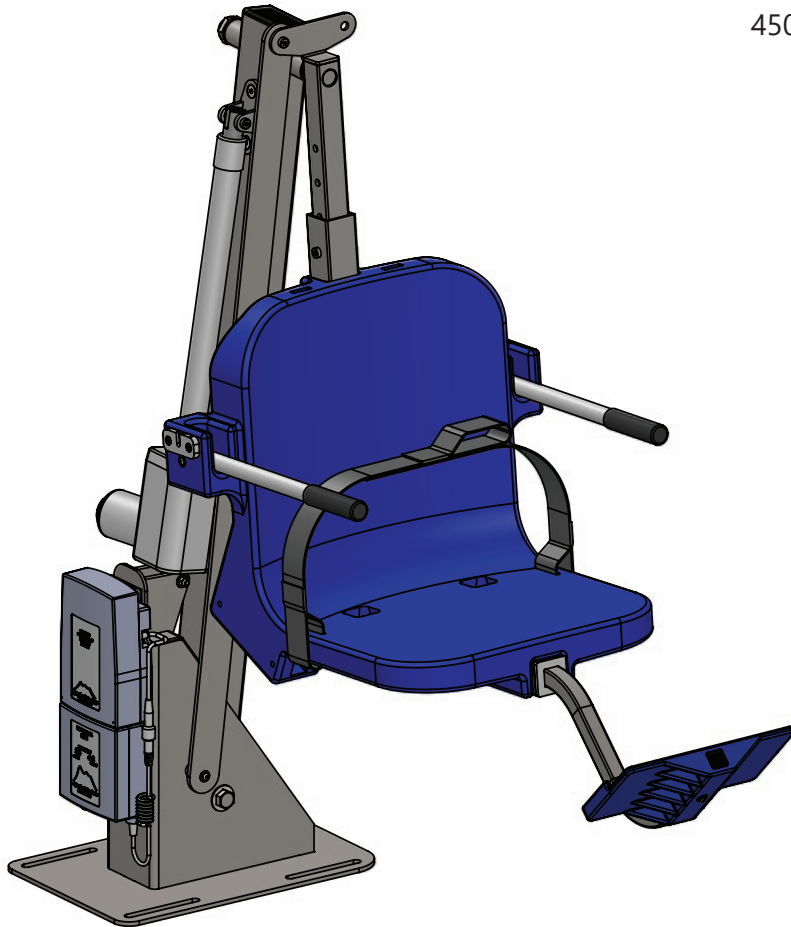

Admiral Pool Lift

PART #: F-ADMRL-05

US PATENT NUMBER: [D507,769 S]
450 LB. [204 kg] MAXIMUM WEIGHT CAPACITY

FOR INDOOR OR OUTDOOR USE

MANDATORY

LEAVE THIS MANUAL WITH LIFT OWNER



READ CAREFULLY

Check entire box and all packing materials for parts. Before beginning assembly, read the instructions and identify parts using the figures and parts listed in this document.

It is critical that all parts be carefully inspected prior to installation. If any damage occurred in transit, Aqua Creek Products, LLC must be notified within three days of receipt of unit.

Proper installation cannot be overstressed, as an improper installation voids Aqua Creek's warranty and may affect the safety of the user.

Admiral Lift

IMPORTANT SAFETY INSTRUCTIONS



When installing and using this electrical appliance, basic precautions should always be followed, including the following:

READ ALL INSTRUCTIONS BEFORE USING

WARNING - To reduce the risk of injury, do not permit children to use this product unless they are closely supervised at all times.

This appliance is not intended for use by persons (including children) with reduced physical, sensory or mental capabilities, or lack of experience and knowledge, unless they have been given supervision or instruction concerning use of the appliance by a person responsible for their safety.

A wire connector is provided on the unit to connect a minimum 8 AWG (8.4mm²) solid copper conductor between this unit and the means for local equipotential bonding.

Check the unit periodically for signs of deterioration: Keep all nuts, bolts and screws tight to be sure the lift is in safe working condition.

SAVE THESE INSTRUCTIONS

Affix supplied ADA POOL/SPA LIFT sign in a location visible from the lift at all times.

Rechargeable batteries are to be removed from the appliance before being charged. Batteries are to be inserted with the correct polarity. If the appliance is to be stored unused for a long period of time, the batteries should be removed. The supply terminals are not to be short-circuited.

REDUCE THE RISK OF DROWNING!

Supervise children at all times.

No jumping or diving from the lift.

Seat may be hot, use caution when entering.

Keep covered when not in use. Inspect and clean before use.

INDOOR BATTERY CHARGER:

AMPERAGE = 0.65 FREQUENCY = 60

24 VOLT BATTERY

AMPERAGE = 8 IP RATING = IPX5

Admiral Lift

Table of Contents

PAGE	DESCRIPTION	PAGE	DESCRIPTION
3	Admiral Components	12	Field Reverse
4	ADA Installation Guidelines	13	Basic Troubleshooting
5-6	Anchor Installation: Core-Drill Retro-Fit	14	Battery Test Cable Instructions
7-8	Anchor Installation: Saw-Cut Retro-Fit/ New Construction	15	Proper Care of Pool & Spa Lifts
9	Admiral Lift Assembly Instructions	16	Admiral Parts List
10	Footrest Installation Instructions	17	Warranty
11	Pinch Point Locations		

Admiral Components

1. ADMIRAL LIFT MAIN ASSEMBLY
2. 24V VITO BATTERY
3. VITO CHARGER
4. VITO HANDSET
5. SAFETY BELT
6. ANCHOR JIG PLATE
(IF ORDERED WITH ANCHOR)
7. ANCHOR INSERT BAG - SET OF 4
(IF ORDERED WITH ANCHOR)
8. HARDWARE BAG
(IF ORDERED WITH ANCHOR)
9. VITO BATTERY TEST CABLE

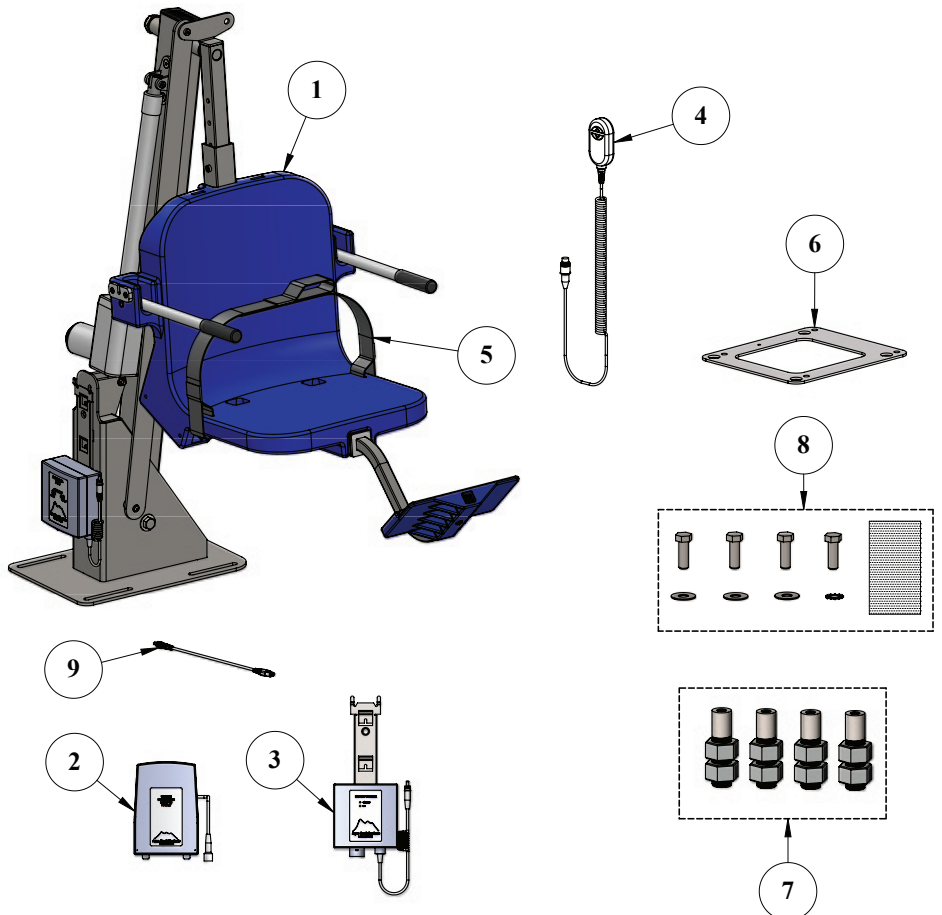

Installation: ADA Guidelines

ADA REQUIREMENTS:

The Admiral Pool Lift is ADA Compliant.

The installation must meet the following requirements:

- Clear deck space dimensions (see FIGURE 1)
- Lift installed between 14.5-19 inches from the pool edge
- Deck slope no greater than 1:48
- The seat must submerge at least 18 inches into the water. The lift should be installed at a location with 42-48 inches of depth (deck to pool floor)
- Anchor setbacks are based on straight pool/spa walls. Curved pool/spa walls will effect the anchor setback.

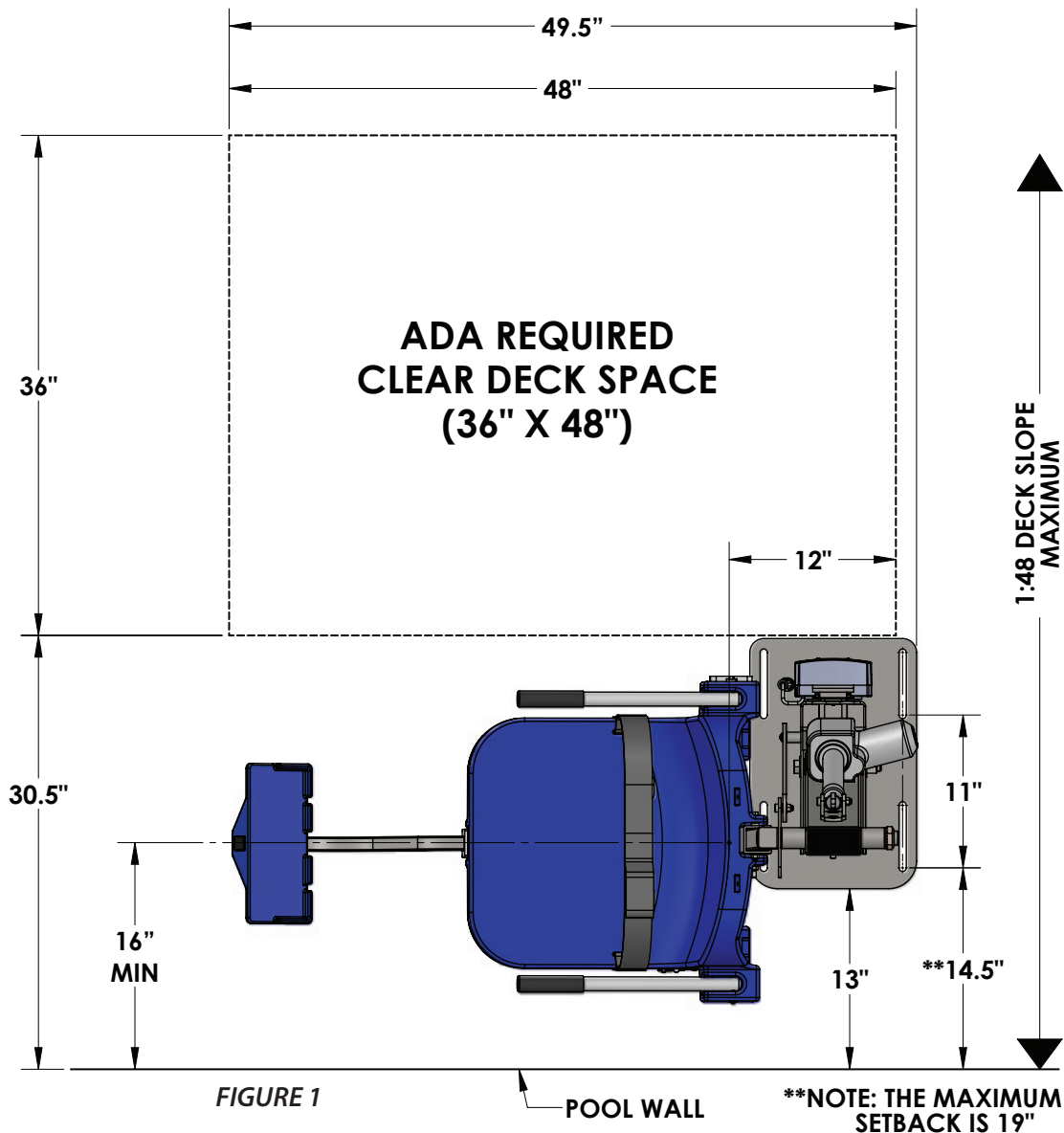

Anchor Installation: Core-Drill Retro-Fit

NOTE: FOR DECKS 6" THICK OR MORE, 2500PSI MINIMUM STRENGTH CONCRETE REQUIRED

You will need:

- Core drill and 1½" core drill bit
- Tape measure
- Marking pen
- Hammer
- Cold chisel
- Torpedo level
- High strength 2-part construction epoxy*
- Masking tape
- Black electrical tape (optional)
- Anti-seize packet

*Aqua Creek recommends either Hilti™ Brand HIT RE-500-SD or Simpson™ brand SET-XP or equivalent (not included)



Anchor jig plate with hardware

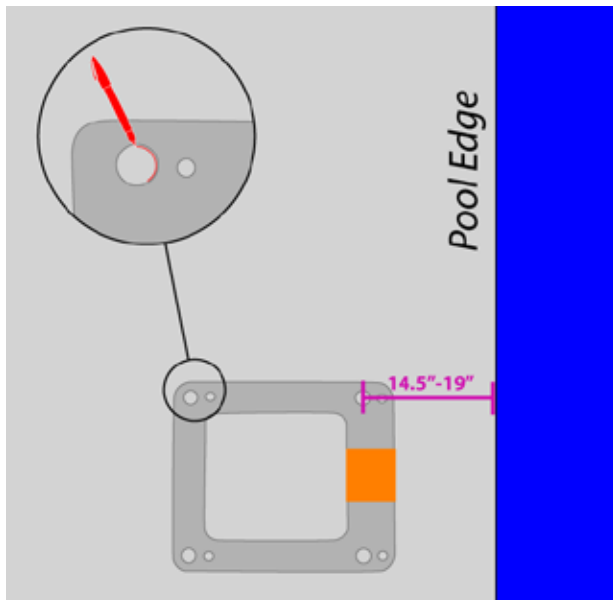

FIGURE 2

1. Mark the 4 hole locations on your deck using the larger holes of the anchor jig plate as a template. For ADA compliance, confirm the center of the jig plate front holes are 14.5 to 19 inches from the pool's edge. *SEE FIGURE 2*

2. Drill the 4 hole locations to 4 1/2 inches deep using the 1 1/2 inch drill bit. Clear all debris and ensure holes are completely dry.

NOTE: Create a depth marker on the drill bit with black electrical tape to make sure you drill to the right depth.

NOTE: Local bonding regulations may require you to drill one hole larger than the others in order to bond at least one of the anchor inserts. You may need to saw cut a portion of your deck.

See "Saw Cutting Retro-Fit Instructions" on page 6.

3. Remove the nuts and the black protective coverings from the threaded anchor inserts.

Anchor Installation: Core-Drill Retro-Fit (CONTINUED)

4. Thread the mounting hardware through the smaller anchor jig plate holes and into the anchor inserts. Be sure to use anti-seize on the threads! Confirm the tops of the inserts are flush with the bottom of the plate.

NOTE: We recommend using masking tape around the holes on the bottom of the anchor jig plate to help prevent the anchor plate from being accidentally epoxied to the pool deck.

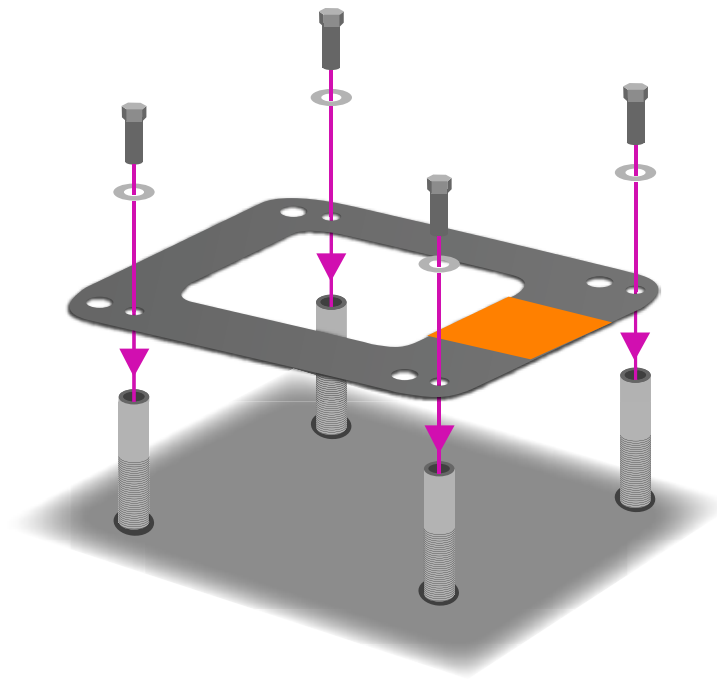

5. Bond at least one of the anchor inserts according to your local code requirements. For more information see NEC Article 680.26.

6. Test fit the anchor inserts to make sure they line up properly. Place the anchor assembly into the pre-drilled holes and use a torpedo level to ensure your anchoring system is level.

7. Remove the anchor assembly and fill each hole halfway with 2-part construction epoxy.

8. Place the anchor assembly back into the holes. Wiggle the assembly as you reinsert it. Make sure the epoxy fully coats the threads.

9. Check that the anchor assembly is level.

10. Once the epoxy has set up, remove the hardware and the anchor jig plate. Your lift is now ready to be mounted to the anchoring system. The anchor jig plate may be recycled or used to install other anchors.

Anchor Installation: Saw-Cut Retro-Fit

You Will Need:

- Concrete saw with diamond blade
- Tape measure
- 4' long straight edge or chalk line
- Sledge hammer
- Cold chisel
- Torpedo level
- String Line
- Concrete & concrete finishing tools
- #5 rebar

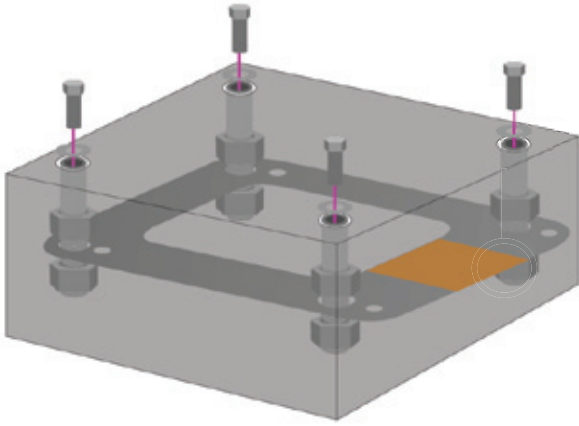

FIGURE A

1. Remove 1 nut from each anchor insert. Place the anchor inserts through the larger hole of the anchor jig plate. Thread the removed nuts back onto the anchor inserts. The anchor plate should be sandwiched between the two nuts on each anchor insert. *SEE FIGURE A*

2. Mark out a section of the pool deck that you are removing. Plan on removing at least 4 feet 0 inches by 4 feet 0 inches.

3. Cut along your marks with a diamond blade concrete saw.

4. Using the sledge hammer break up the concrete within the cut area and remove the pieces.

5. Install rebar in the open area of the deck. Tie the rebar into the existing deck if possible. *SEE FIGURE B*

6. Set the anchor system in place. For ADA compliance and clearance, make sure the center of the large anchor jig plate hole is between 14.5 and 19 inches from the pool's edge. *SEE FIGURE C, PAGE 7*

7. Using the string line or a straight edge, confirm the top of each anchor body is level with the **FINISHED** deck surface. Each anchor body can be individually adjusted by turning the nuts with a large wrench.

8. Bond the anchoring system according to your local code requirements by using the bonding lug on the anchor plate. *SEE FIGURE C, PAGE 7 (See NEC Article 680.26)*

9. Pour concrete and finish the pool deck surface. *SEE FIGURE A*

10. Once the concrete has cured, the lift is ready to be mounted to the anchoring system.



FIGURE B

Anchor Installation: New Construction

NOTE: For installations where a new deck is being poured, or where a dedicated pad is being poured just for the pool lift, the concrete must satisfy the ADA requirements outlined on page 3 of this manual.

Your pool deck must be at least 4 feet - 0 inches long by 4 feet - 0 inches wide by 6 inches thick. It must be reinforced with 5 sticks of #5 rebar each way, 2 inches clear (min) from the top and bottom of the footing.

1. Remove 1 nut from each anchor insert. Place the anchor inserts through the larger hole of the anchor jig plate. Thread the removed nuts back onto the anchor inserts. The anchor plate should be sandwiched between the two nuts on each anchor insert.

SEE FIGURE A, PAGE 6

2. Install rebar in the open area of the deck.

SEE FIGURE B, PAGE 6

3. Set the anchor system in place. For ADA compliance and clearance, make sure the center of the large anchor jig plate holes are between 14.5 and 19 inches from the pool's edge. SEE FIGURE C

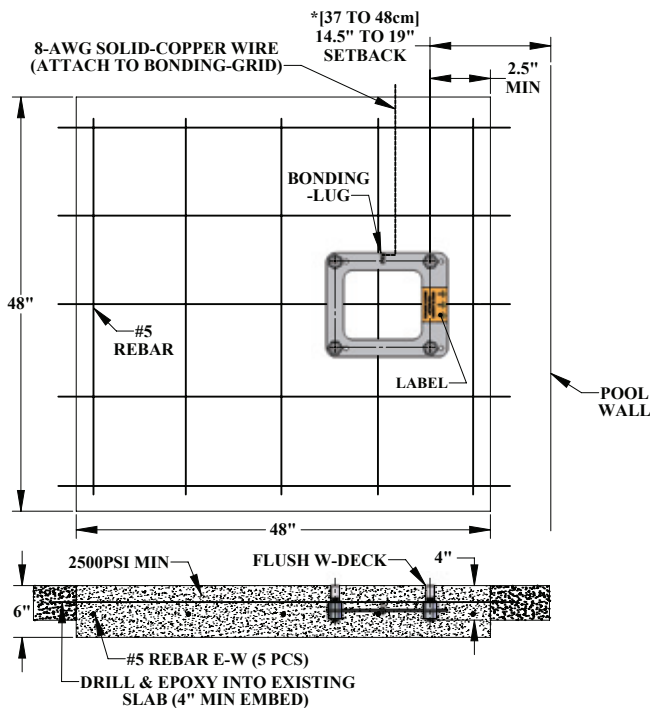

*SETBACK DIMENSIONS ARE FOR **FLAT DECK** APPLICATIONS. FOR SLOPED DECKS OR OTHER FEATURES, CONTACT AQUA CREEK BEFORE INSTALLATION.

FIGURE C

4. Make sure the top of each anchor body is flush with the **FINISHED** deck surface. Each anchor body can be adjusted individually by turning the nuts with a large wrench.

5. Bond the anchoring system by using the bonding lug on the anchor jig plate. Bond the system according to your local code requirements. (See NEC Article 680.26)

SEE FIGURE C

6. Pour your concrete and finish the pool deck surface.

SEE FIGURE A, PAGE 6

7. Once the concrete has cured the lift is ready to be mounted to the anchoring system.

Admiral Assembly Instructions

1. Attach seat belt to the seat. *SEE FIGURE D*

2. Install the Admiral pool lift onto the four (4) anchors using the supplied 1/2 inch x 1 1/2 inches stainless steel hex head bolts and 1/2 inch stainless steel washers. Make sure all bolts are tight before using the lift.

3. Apply dielectric grease to the plug terminals, including the o-ring seal. Plug the handset cable into the large handset socket on the bottom of the control box. Press the cord end firmly into the socket until you are sure it is completely in the socket. Failure to fully push the remote cord into the socket may result in faulty or interrupted operation.

4. Before installing the battery, place it on the charging unit and let it charge for 24 hours. Make sure the orange "charge" light illuminates when the battery is being charged. When the orange charge light shuts off, the battery is fully charged.

5. Remove the fully charged battery from the charger and install it on top of the control box. The battery will line up with the control box, and will 'click' when it properly locks in place. Apply dielectric grease to the plug terminals, including the o-ring seal, and then connect the battery cable to the control box cable.

6. With the lift completely assembled, run the lift fully out and back in 3-5 times, without weight, for the lifts "break in" cycle period.

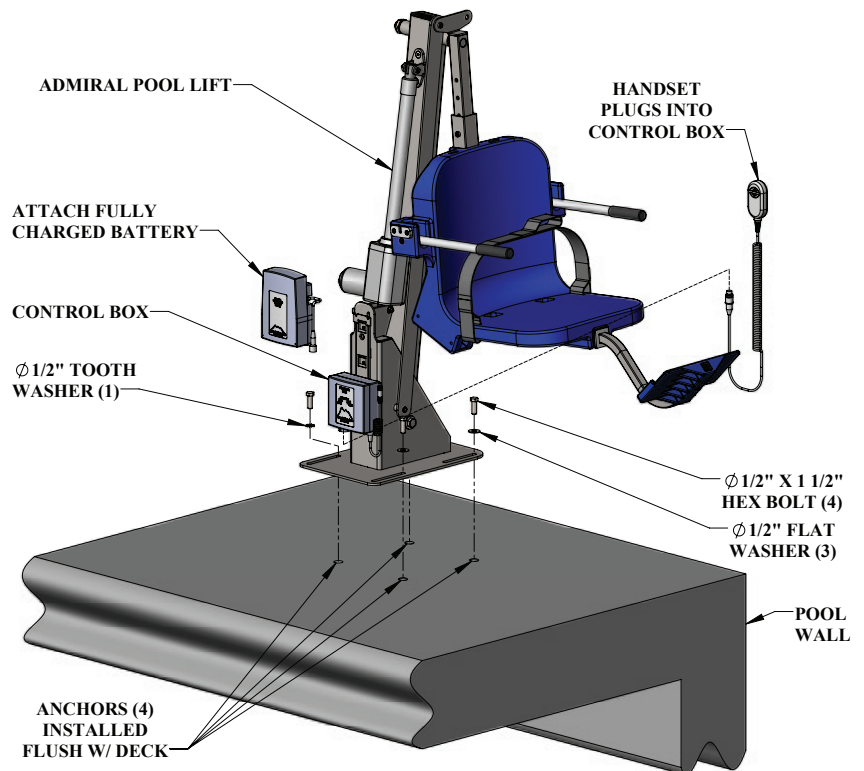

WHEN NOT IN USE, STORE THE BATTERY ON THE CHARGER!

Footrest Installation Instructions

The Aqua Creek footrest assembly is designed to fit under the chair and is installed inside the 2" square tubing that supports the chair from underneath. To install the footrest;

1. Insert the footrest assembly into the 2 x 2 square tubing that supports the chair until the plastic insert of the footrest assembly sits flush against the end of the 2 x 2 tube.
2. Using the supplied 1/4" hardware, fasten the footrest assembly to the 2 x 2 tubing.

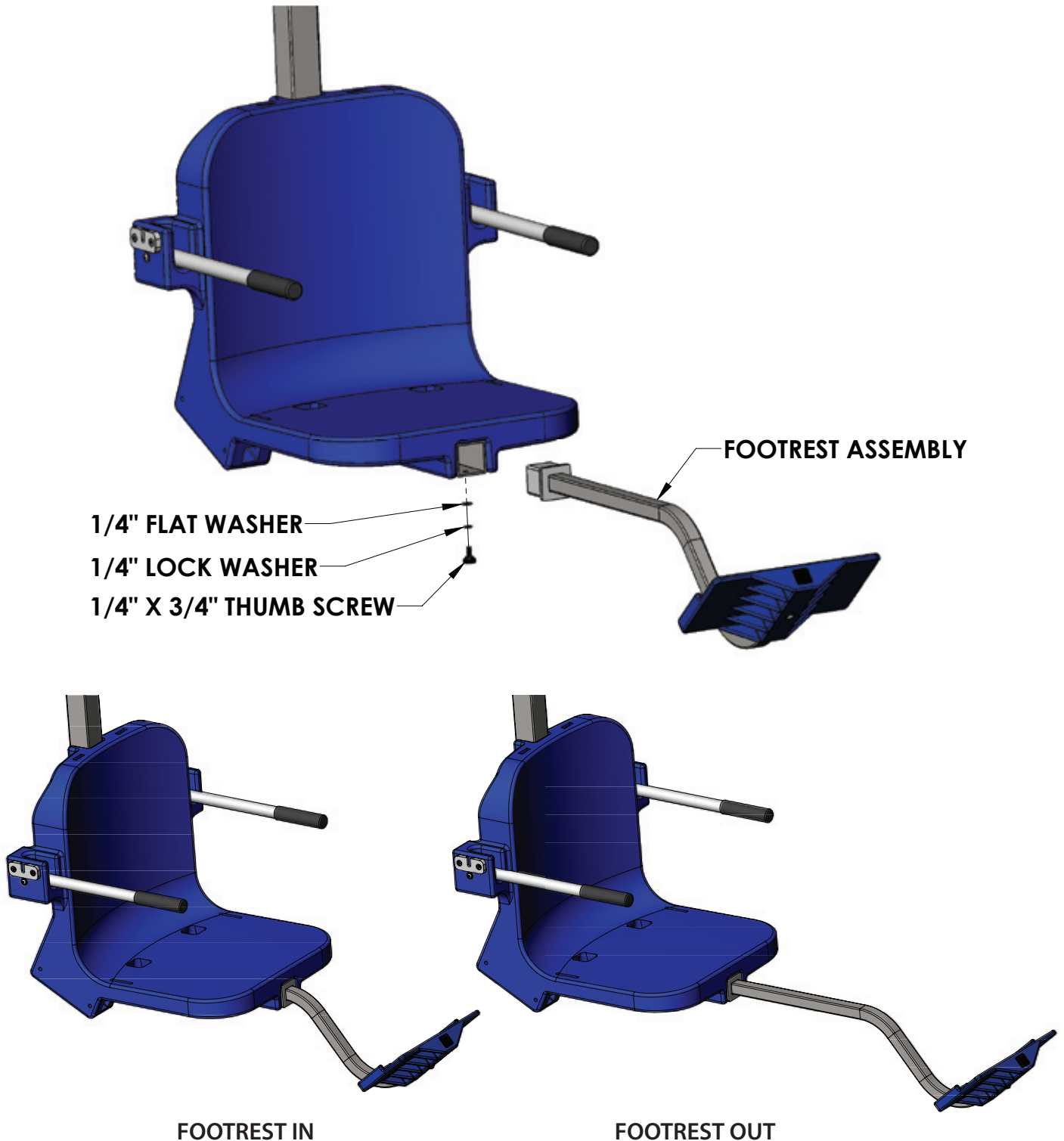

Pinch Point Locations

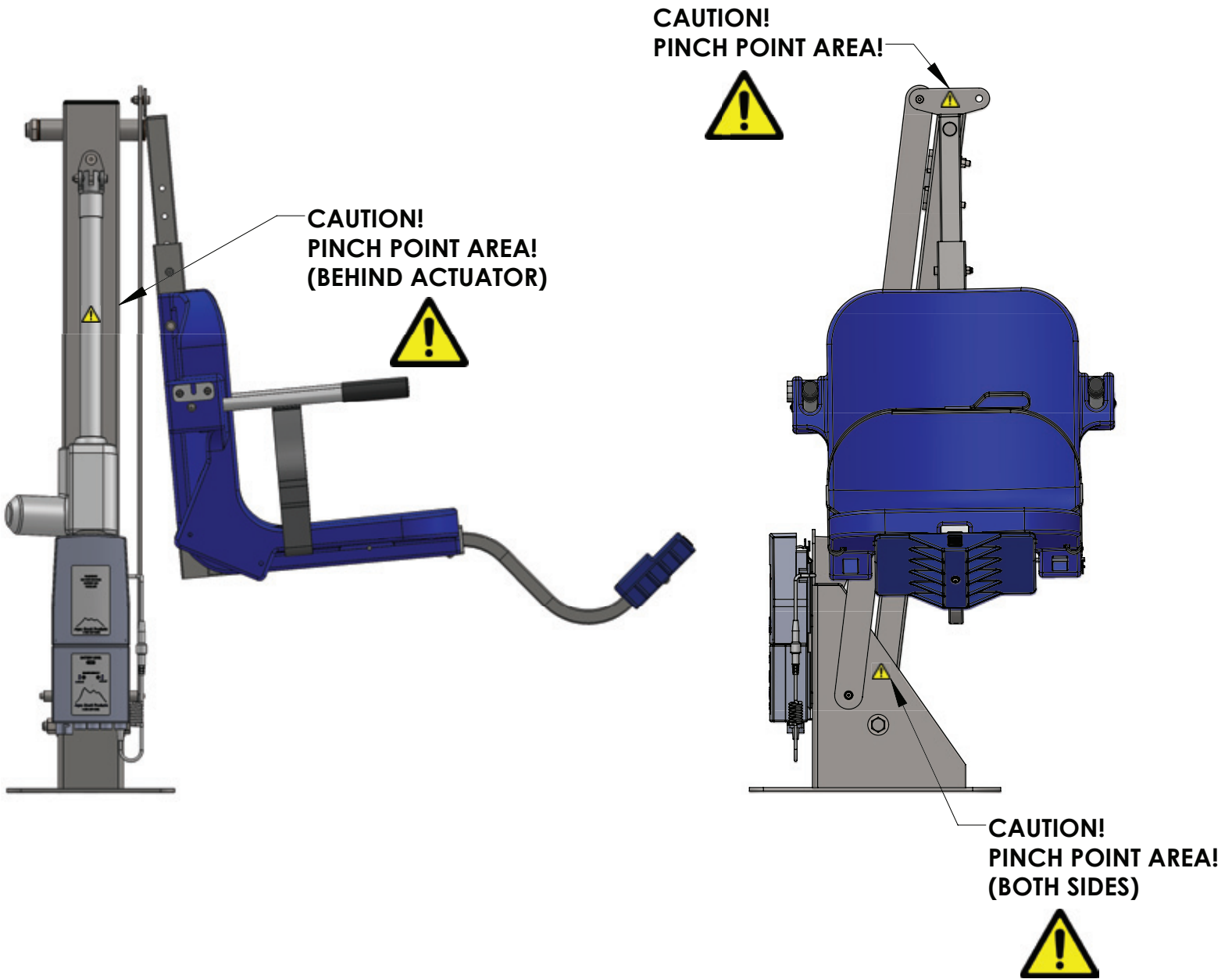

Field Reverse

To reverse the direction of the seat on the lift begin by removing the 1" jam nylock nut from the chair cradle. Then remove the 3/8" shoulder bolt, flange bushing, sleeve bushing, flat washer and nylock nut the connects the chair cradle assembly to the control arm. Next, remove the 1/4" button-head bolt and flat washer connecting the control arm to the base of the lift. The chair cradle assembly and control arm can now both be slid freely away from the lift and "flipped" to the opposite side. Also, remove the 3/8" shoulder bolt, 5/16" flat washer and nylock nut connecting the actuator head to the base of the lift. With the hardware removed, rotate the head of the actuator 180 degrees and then reinstall the hardware. Replace all components and hardware in the reverse order of how it was uninstalled.

You Will Need:

- 5/32" ALLEN WRENCH
- 3/16" ALLEN WRENCH
- 1/2" WRENCH
- 1-1/2" WRENCH

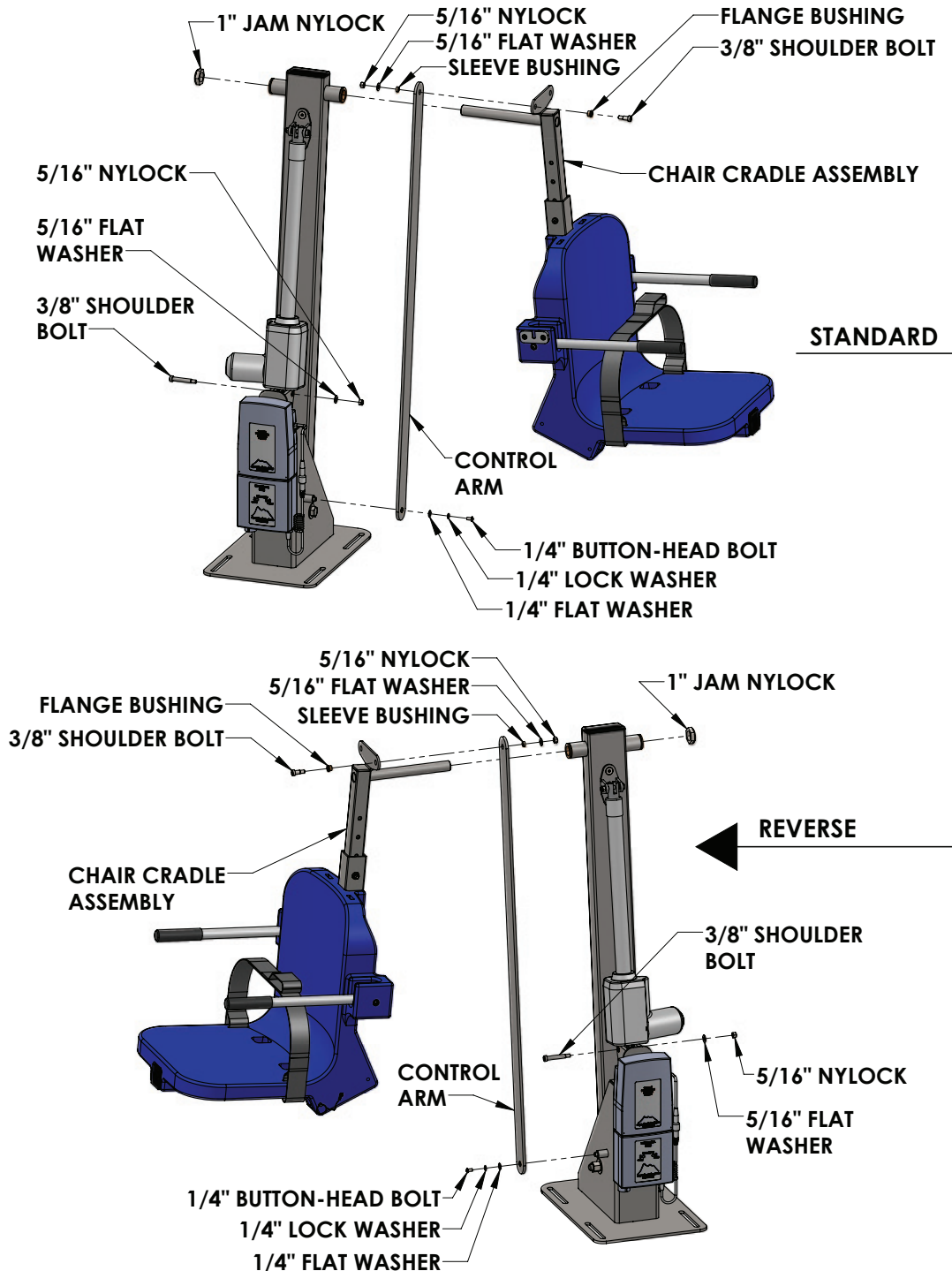

Basic Troubleshooting

Problem: The lift won't move.

Solution:

1. Make sure the cords are properly plugged in:



NOT Properly Inserted:
The cord plug is flush with or sticking out of the outlet



Properly Inserted:
The cord plug is recessed into the outlet

Check the ends of the cords for corrosion or damage. The cord plugs should be recessed into the outlet. You should feel them pop into place when they are correctly inserted.

2. Check the contact points:



Make sure the contact point of the control box and the battery are not damaged or corroded. If there is corrosion clean with Scotch-Brite™ pad. Put some dielectric grease on the contact points before reattaching the battery.

3. Make sure the battery is fully charged:



The Charger is ON when the green light is glowing

The Battery is CHARGING when the orange light is glowing

When the Battery is fully charged the orange light will stop glowing

Problem: The lift stopped moving and is stuck.

Solution:

1. Press the Emergency button

Press the emergency retract button on the front of the control box to retract the lift.

Note: the lift will not retract if the battery is not fully charged or if the control box is not working. The emergency button only overrides the remote handset.



For troubleshooting videos Visit: www.aquacreek.com or scan the QR Code below using your smartphone.

FOR TROUBLESHOOTING ASSISTANCE



Note: If you feel your lift is malfunctioning due to a faulty battery or connections, contact Aqua Creek Products for a testing kit.

Battery Test Cable Instructions

WARNING! DO NOT ATTEMPT TO DIRECTLY PROBE THE BATTERY CONNECTOR TO TEST VOLTAGE. THIS MAY CAUSE PERMANENT DAMAGE TO THE BATTERY! USE THE SUPPLIED BATTERY TEST CABLE ONLY FOR CHECKING THE BATTERY VOLTAGE!

The Aqua Creek 24V battery has a cable and connector for connecting to the control box or to the battery charger. The battery connector is not suitable to check the battery voltage, as it is very hard to probe the connector without shorting-out the battery, which will cause damage. For this reason, a separate battery test cable is provided. To safely check the battery voltage, use a voltmeter or multimeter with standard test probes, and insert the probes into the test cable as shown below.

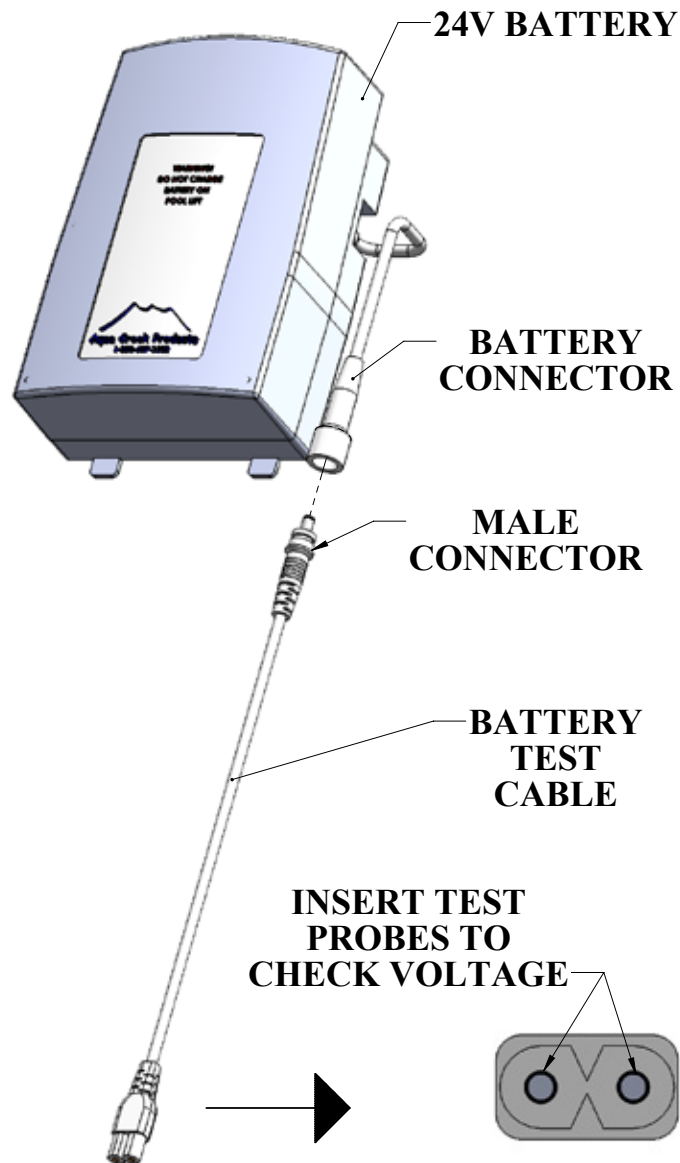

Proper Care of Pool & Spa Lifts

PROCEDURE	BEFORE EACH USE	DAILY	WEEKLY	MONTHLY
Check battery level indicator on control box	✓			
Run the lift through a complete test cycle (fully extend actuator) to verify it is functioning properly	✓			
Wash lift with fresh water and dry with clean, soft, non-abrasive cloth		✓		
Recharge battery		✓		
Visually inspect lift for damage, corrosion, and loose or missing hardware		✓		
Check all contact points for damage and/or corrosion			✓	
Repair, clean and apply dielectric grease to all contact points			✓	
Thoroughly clean lift frame and apply a liberal coat of car wax to maintain the lift's finish				✓
Check all Warning and Cautionary labels to make sure they are not faded or worn. Replace as needed.				✓

PROPER CARE NOTES

- **Use only fresh water to wash your lift. Do not wash with pool water.**
- Use only clean, soft, non-abrasive cloths on your lift.
- Do not store lift in pump room or near chemicals.
- Do not allow children to play on or around this lift.
- When cleaning the lift, do not spray water directly on control box or battery.
- The lift may need to be bonded according to local code requirements.

STAIN REMOVAL TIPS:

To remove stubborn stains from finish, spray affected area with mild dish soap, rub briskly with a 3M Scotch Brite™ pad. Use white epoxy paint to touch up the finish. Apply wax to protect when dry.

For service and/or replacement parts, contact Aqua Creek Products
Toll free: (888) 687-3552

Admiral Parts List

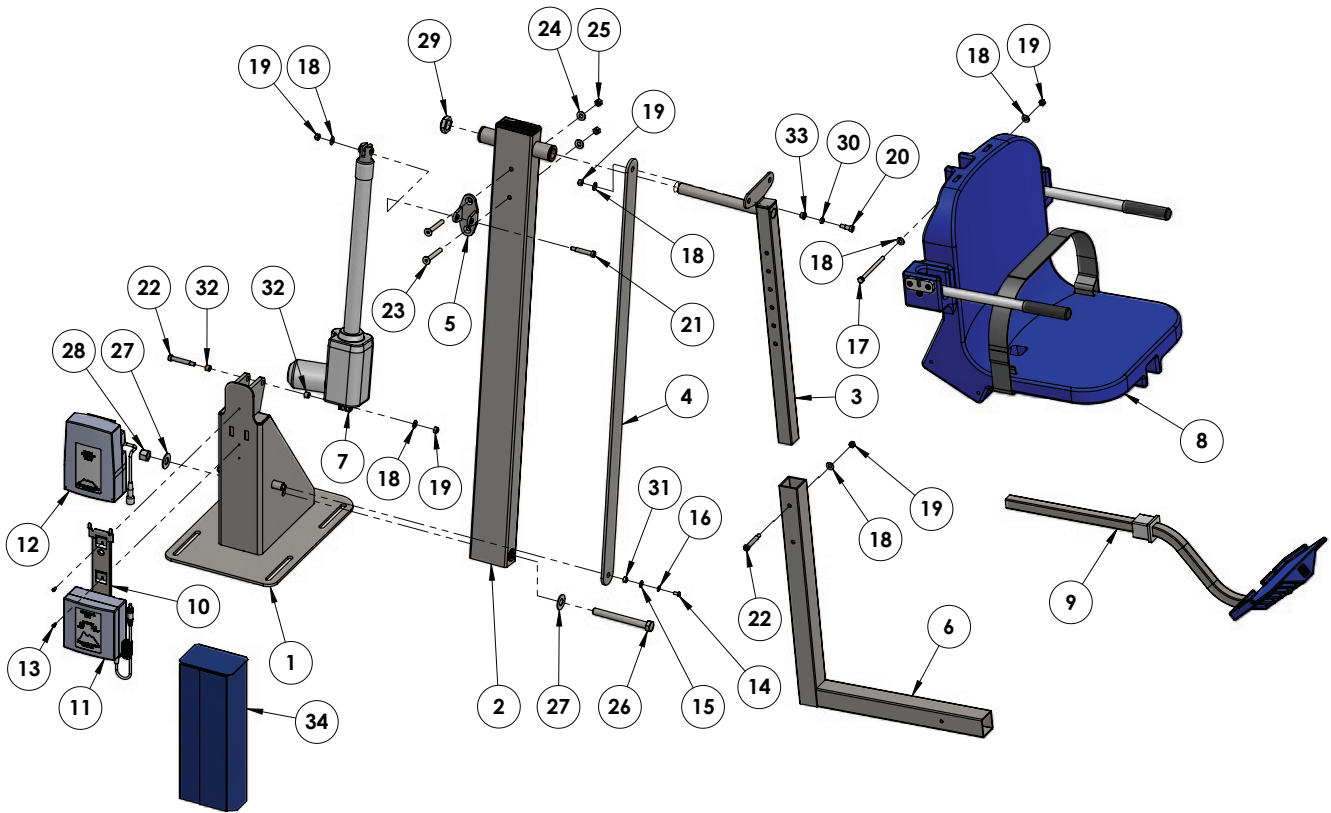

ITEM #	QTY	PART #	DESCRIPTION
1	1	ADM-100-00	BASE WELDMENT
2	1	ADM-200-00	MAIN FRAME ASSEMBLY
3	1	ADM-300AWM-00	ADJUSTABLE SEAT POLE
4	1	ADM-401-02	CONTROL ARM
5	1	PF2-500-00	BRACKET ASSEMBLY
6	1	REVWM-800-00	CHAIR CRADLE
7	1	340665-00	LINAK 400MM PULL ACTUATOR
8	1	F-0904CA-A	CHAIR ASSEMBLY
9	1	F-FRB-03	FOOTREST ASSEMBLY
10	1	GT10 (CONTROL BRACKET)	VITO CONTROL BRACKET
11	1	VCB10	VITO CONTROL BOX
12	1	VCP100-29800	24V VITO BATTERY
13	2	BSH 10 X 3/8	10-24 X 3/8 SHCS
14	1	BB 1/4 X 1/2	1/4-20 X 1/2 BHSCS
15	1	WF 1/4	1/4 FLAT WASHER
16	1	WL 1/4	1/4 LOCK WASHER
17	1	BH 5/16 X 4 1/2	5/16-18 X 4 1/2 HCS
18	6	WF 5/16	5/16 FLAT WASHER
19	5	NN 5/16	5/16-18 NYLOCK NUT

ITEM #	QTY	PART #	DESCRIPTION
20	1	BS 3/8 X 9/16	3/8 X 9/16 SHOULDER BOLT
21	1	BS 3/8 X 1 3/4 18-8	3/8 X 1 3/4 SHOULDER BOLT
22	2	BS 3/8 X 2 18-8	3/8 X 2 SHOULDER BOLT
23	2	BC 3/8 X 3	3/8-16 X 3 FHSCS
24	2	WF 3/8	3/8 FLAT WASHER
25	2	NN 3/8	3/8 NYLOCK NUT
26	1	BH 5/8 X 5 7/8 18-8	5/8 X 5 7/8 HCS
27	2	WF 5/8	5/8 FLAT WASHER
28	1	NN 5/8	5/8 NYLOCK NUT
29	1	NNJ 1	1" NYLOCK JAM
30	1	BRB EP060803	3/8 X 1/2 X 3/16 SLEEVE BUSHING
31	1	BRB SS-1216-4	3/8 X 1/2 X 1/4 BRONZE SLEEVE
32	2	BRB SS-1216-6	1/2 X 3/8 X 3/8 BRONZE SLEEVE
33	1	BRB FB-68-3	3/8 X 1/2 X 3/8 X 3/32 BRONZE FLANGE
34	1	F-UBC	BATTERY COVER

AQUA CREEK PRODUCTS, LLC LIMITED FIVE (5) YEAR WARRANTY:
ADMIRAL POOL LIFT
(ITEM #: F-ADMRL, F-ADMRLDD)

Aqua Creek Products, LLC (a.k.a. Aqua Creek) warrants to the original end user purchaser that products manufactured by Aqua Creek, when properly installed in accordance with assembly and installation instructions, and properly used and maintained, shall be free from defects in material and workmanship for a period of **five (5) years from the date of original purchase**, provided that Aqua Creek receives prompt notice in writing of any defect or failure and satisfactory proof thereof, with the following exception(s):

Exceptions:

- All electrical components, including the linear actuator shall have the following warranty period:
 - Year 1-2: 100% Coverage
 - Year 3: 60% Coverage (Customer is responsible for 40% of replacement cost)
 - Year 4: 50% Coverage (Customer is responsible for 50% of replacement cost)
 - Year 5: 40% Coverage (Customer is responsible for 60% of replacement cost)
- Hydraulic actuators and mesh slings shall have a warranty period of **one (1) year from the date of original purchase**.
- Powder coat finish scratches, scrapes, corrosion, or dents from customers normal use, negligence, or abuse

This warranty specifically excludes reimbursement for labor to remove, repair, or install the product and any shipping charges. These warranties do not cover any damages due to accident, misuse, abuse, negligence or failure to properly maintain any products, or normal wear and tear from day to day operations. In the event that any products are altered, repaired, or improperly installed or improperly used by anyone without the prior written approval by Aqua Creek, all warranties are void. **IMPORTANT: AMOUNT OF WEIGHT PLACED ON LIFT SHALL NOT EXCEED THE RATED LIFTING CAPACITY FOR THE LIFT. NEVER OPERATE THE LIFT UNDER LOAD IN A DRY POOL (WITH NO WATER IN THE POOL).** It is the responsibility of the lift owner to verify the weight of the patron for warranty claim purposes and to ensure that the lift is not overloaded. Non-payment for product to Aqua Creek may void warranty.

To initiate a warranty claim, the owner of an Aqua Creek product must provide the place of purchase, in writing, with a full description of the product, its serial number, the dates of purchase and installation, and the exact nature of the defect. Within thirty (30) days after receipt of a written warranty claim by Aqua Creek, and barring any unforeseen delays, the place of purchase will be notified of Aqua Creek's decision regarding the claim.

If requested by Aqua Creek, any defective product must be returned, freight prepaid by customer, to Aqua Creek's designated factory location or duly appointed distributor for inspection and/or repair. Aqua Creek will, at its option, repair or replace the failed or defective item, and deliver the repaired product or replacement to the customer. All freight charges are the responsibility of the customer. Products returned to Aqua Creek for which Aqua Creek provides replacement under this limited warranty shall become the property of Aqua Creek. A new warranty period shall **NOT** be established for the repaired or replaced products. Such products shall remain under warranty only for the remainder of the original warranty period on the original products purchased.

This written limited warranty constitutes the final, complete and exclusive statement of warranty terms. No person or organization is authorized to make any other specific or implied warranties or representations on behalf of Aqua Creek.

THE WARRANTIES SET FORTH HEREIN ARE IN LIEU OF ALL OTHER WARRANTIES, EXPRESSED OR IMPLIED, WHICH ARE HEREBY DISCLAIMED AND EXCLUDED, INCLUDING WITHOUT LIMITATION ANY WARRANTY OF MERCHANTABILITY OR FITNESS FOR A PARTICULAR PURPOSE OR USE.

THE SOLE AND EXCLUSIVE REMEDIES FOR BREACH OF ANY AND ALL WARRANTIES WITH RESPECT TO THE PRODUCTS SHALL BE LIMITED TO REPAIR OR REPLACEMENT AT AQUA CREEK'S DESIGNATED FACTORY LOCATION, OR DULY APPOINTED DISTRIBUTOR, OR IN PLACE AT AQUA CREEK'S OPTION. IN NO EVENT SHALL AQUA CREEK'S LIABILITY EXCEED THE ENTIRE AMOUNT PAID TO AQUA CREEK BY THE ORIGINAL PURCHASER FOR THE FAILED OR DEFECTIVE PRODUCT.

IN NO EVENT SHALL AQUA CREEK PRODUCTS, LLC BE LIABLE FOR ANY INCIDENTAL, CONSEQUENTIAL, SPECIAL, INDIRECT, PUNITIVE OR EXEMPLARY DAMAGES OR LOST PROFITS FROM ANY BREACH OF THIS LIMITED WARRANTY OR OTHERWISE.

THIS WARRANTY GIVES YOU SPECIFIC LEGAL RIGHTS AND YOU MAY ALSO HAVE OTHER RIGHTS, WHICH MAY VARY FROM STATE TO STATE. SOME STATES DO NOT ALLOW THE EXCLUSION OR LIMITATION OF INCIDENTAL, SPECIAL OR CONSEQUENTIAL DAMAGES, SO SOME OF THE ABOVE LIMITATIONS OR EXCLUSIONS MAY NOT APPLY TO YOU.

Aqua Creek Products, LLC
9889 Garrymore Lane
Missoula, MT 59808
Toll Free: (888) 687-3552
Local/Intnl: (406) 549-0769
www.aquacreek.com