

FILL-LID STANDARD 10" SKIMMER & AUTOFILL COVER

INSTRUCTIONS FOR FL10xxx
(xxx = COLOR SUFFIX)

READ AND FOLLOW ALL INSTRUCTIONS

PRODUCT IMAGE

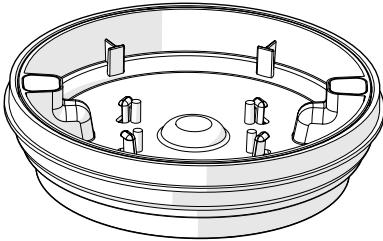

Model # FL10xxx

Fits all AquaStar skimmers and autofills and most standard skimmer.

PRODUCT DIMENSIONS AND BREAKAWAY

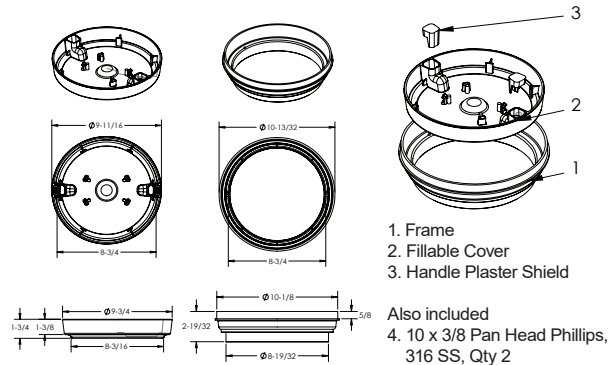

1. Frame
2. Fillable Cover
3. Handle Plaster Shield

Also included
4. 10 x 3/8 Pan Head Phillips,
316 SS, Qty 2

READ, THEN KEEP THESE INSTRUCTIONS FOR FUTURE REFERENCE

For more installation instructions, please consult your local building codes.

1. Pour the desired deck material to be used into the fillable cover.

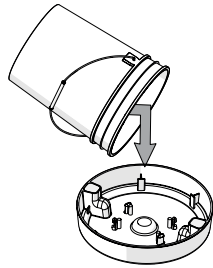

2. Agitate to settle the desired material.

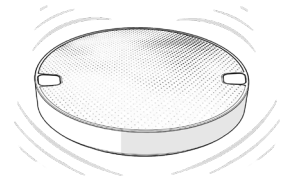

3. Remove orange plaster shields.

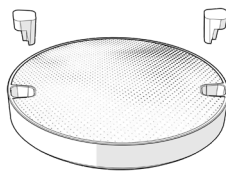

4. Gently wash and clean excess material from fillable cover and let dry.

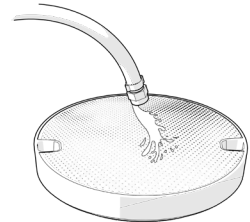

5. Place the frame on the skimmer/autofill and set to desired elevation and level.

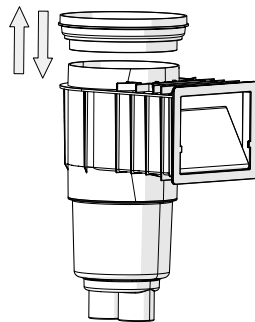

6. Install and secure the cover with the screws provided. Each cover is now ready to be easily removed and walked upon.

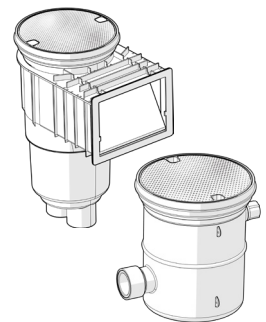

THE AQUASTAR COVER THAT VIRTUALLY DISAPPEARS WITH EVERY DECK FINISH