

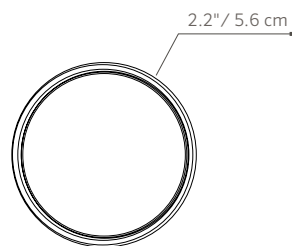

*The MU is one of the most versatile spotlights on the market and is the perfect choice for the discriminating landscape designer. Using several different filter and accessory options, the designer can control shape, color shifts, and light output. A wide variety of effects can be produced by adding our RecessorRing®, Hex Baffle® or one of our many filters, spread lens or glare control options.*

## MU: Up Light

<b>MATERIALS:</b>	Die-cast aluminum A380 housing and shroud with stainless steel hardware. Die-cast zinc/aluminum alloy knuckle
<b>SOCKET:</b>	MR16 GU5.3 socket with retaining clips
<b>WIRING:</b>	18 AWG SPT-1W 105° C 300V
<b>POWER:</b>	Input 10-15VAC/VDC 50/60Hz. Remote transformer required (sold separately)
<b>LAMP OPTIONS:</b>	No Lamp, LED lamp, ZD LED lamp, Halogen

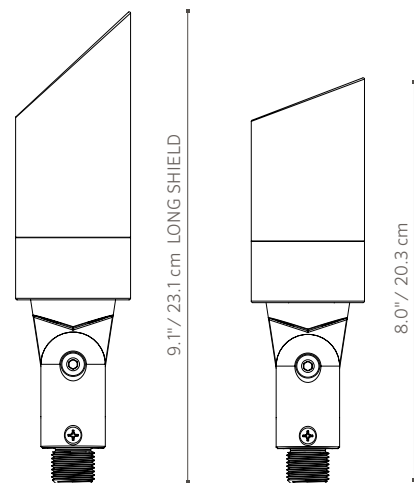



# MU: Up Light

< LONG SHIELD













**FACTORY INSTALLED OPTIONS:** Order 1 + 2 + 3 (optional) + 4

Step	Description	Code
1	FIXTURE	MU
2	LAMP	NL (No lamp), 20 (Halogen BAB), 35 (Halogen FMW), LED20WFL <sup>†</sup> (LED 4W BAB), LED35WFL <sup>†</sup> (LED 5W FMW), ZD35WFL <sup>†</sup> (ZD LED 5W FMW)
3	OPTIONAL SHIELD	LS (Long Shield)
4	FINISH	WG, FW, AL, BZ, DG, WI, SB, FB

**EXAMPLE:** MU-NL-SB = MU - No Lamp - Sedona Brown Finish

<sup>†</sup> LED lamps available only with BZ/FB finishes and clear lenses

**FIELD INSTALLED OPTIONS:** Order Individually

Glare Control	Mounts							
<b>Hex Baffle</b> (250015260000)	<b>Super Slot Spike</b> (753900) 2" x 10" Included ▾				<b>Coupling: Straight</b> (COUP-XX**) 1.3" x 2.0"			
<b>RecessorRing</b> (RRMR16)	<b>Long Slot Spike</b> (250015840000) 2.5" x 10"				<b>Coupling: 90° Elbow</b> (ELBW-050-XX**) 1.3" x 2.0"			
	<b>Super J-Box</b> (SJ-XX**) 2.5" x 12"				<b>Coupling: T-Mount</b> (TMNT-050-XX**) 3.0" x 2.2"			
	<b>Post Mount</b> (PM-XX**) 2.5" x 13"				<b>Gutter Mount</b> (GM-SS) 4.0" x 4.0"			
<b>Lenses/Filters</b>								
<b>Frosted</b> (250015170000)	<b>Super Slot Spike</b>	<b>Long Slot Spike</b>	<b>Super J-Box XX**</b>	<b>Post Mount XX**</b>	<b>Coupling: Straight</b>	<b>Coupling: 90° Elbow</b>	<b>Coupling: T-Mount</b>	<b>Gutter Mount</b>
<b>Spread</b> (250013550000)	<b>Tree Box</b> (TB-XX**) 5.4" x 1.9"				<b>Sign Light Riser</b> (YY-R-SL-XX**) 0.8" diameter w/45° inward curve			
<b>Solite Spread</b> (250015240000)	<b>Wall Plate: 1-Gang</b> (WP-1G-050-XX**) 3.4" x 5.1"				<b>Straight Riser</b> (YY-R-XX**) 0.8" diameter			
<b>Dichroic Peach</b> (250015230000)	<b>Wall Plate: Round</b> (WP-RD-050-XX**) 5.0" diameter							
<b>Dichroic Blue</b> (250015200000)								
<b>Dichroic Green</b> (250015210000)	<b>Tree Box</b>	<b>Wall Plates: 1-Gang</b>	<b>Wall Plates: Round</b>	<b>Sign Light Riser</b>	<b>Straight Riser</b>			
<b>Dichroic Red</b> (250015220000)								
<b>Light Blue</b> (250015190000)								

The MU includes your choice of halogen MR-16 lamp, clear lens, choice of powder coat finish, and a Super Slot Spike.

\*\* Denotes finish code



**EXAMPLE:** RRMR16 = RecessorRing  
PM-SB = Post Mount - Sedona Brown Finish