



Round (RD)



Square (SQ)



Spot (ST)



Wall Wash (WW)

PROJECT
CATALOG #
TYPE
NOTES

MO Recessed Wall Light DESIGNER PREMIUM

This glare-free wall light in 1 or 3 LED. Available in four brass faceplate options. An RGBW version is also available for use with Luxor®Systems.

Quick Facts

- Die-cast brass construction
 - Natural, powder-coated, or antiqued brass finish
 - Lumileds® integrated LEDs
 - Color temperature filters
- Compatible with Luxor Technology
 - Phase and Luxor dimmable
 - Input voltage: 10 to 15 VAC/VDC

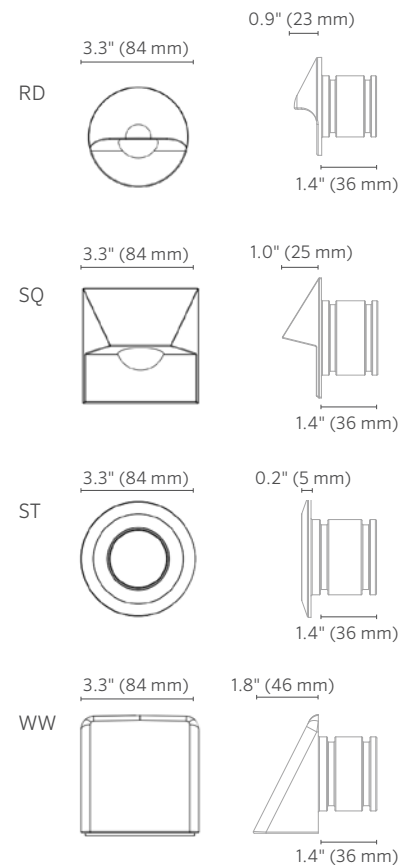

MO Recessed Wall Light SPECIFICATIONS

Output	1 LED	3 LED	ZD3LEDT	ZDC
Total Lumens^{†‡}	13 to 68	33 to 169	21 to 102	61
Input Voltage	10 to 15 V	110 to 15 V	110 to 15 V	11 to 15 V
Input Power	2.0 W	4.2 W	4.2 W	6.0 W
Power Consumption (VA)	2.4 W	4.5 W	4.5 W	7.2 W
Efficacy (lm/W)	18	21	29	19
Color Rendering Index (CRI)	80+	80+	--	80+
Max Candelas[‡]	31	79	195	51
Dimming				
Primary Dimming (Transformer)				
Secondary Dimming (Fixture)	Phase**, Luxor	Phase**, Luxor	Phase**, Luxor	Luxor
RGBW Available	No	No	No	Yes
Luxor Compatibility				
Default	Zoning	Zoning	--	--
ZD Option	Zoning/Dimming	Zoning/Dimming	Zoning/Dimming	--
ZDC Option	--	--	--	Zoning/Dimming/Color
Minimum Rated Life (L70) Hrs	72,000	72,000	72,000	72,000
BUG Rating (RD & SQ)	B0-U1-G0	B0-U1-G1	B0-U1-G1	B0-U1-G0

[†] Measured using the 3,900K CCT. Multipliers for other CCTs include 0.80 (2,700K), 0.65 (4,500K), and 0.65 (5,200K).

[‡] Measured using the Round (RD) faceplate. Multipliers for other faceplates include: 1.0 (Square), 2.0 (Spot), and 0.4 (Wall Wash).

** For optimal performance, use a trailing-edge (reverse phase-cut) dimmer.

MO Recessed Wall Light SPECIFICATIONS

FX Luminaire

FX Luminaire is an industry-leading manufacturer of landscape and architectural lighting products with a focus on the advancement of LED technology and digital lighting control with zoning, dimming, and color adjustment capabilities. We offer a full spectrum of specification-driven lighting fixtures that can be utilized to create elegant, cutting-edge landscape lighting systems for commercial or residential applications. Our products are available exclusively via our extensive professional distributor network.

Materials

Die-cast C360 brass faceplate, A380 aluminum housing, and ABS construction conduit sleeve.

Socket

Socket contains MoistureBlock™ Technology, preventing moisture from wicking up into sealed areas of the fixture.

Warranty

10-year limited warranty

Lamp

Integrated module with Lumileds LEDs. Gold-plated connectors and conformal coated for maximum reliability and corrosion resistance. Proprietary onboard intelligent driver uses firmware-controlled temperature regulation, maximizing LED life. Field upgradable and replaceable, the LEDs are rated to 72,000 hrs. Maximum drive current: 1 A.

Optics

Default color temperature is 2,700K (Warm). Field-serviceable beam angle lenses included with fixture: 35° Flood (pre-installed) and 60° Wide Flood. Beam angle is calculated using the LM-79 method for SSL luminaires.

Wiring

18 AWG (1 mm); SPT-1W; 220°F (105°C); 300V; 10' (3 m) length

Faceplate

Die-cast brass faceplate.

Power

Input 10 to 15 Vac/Vdc, 50/60 Hz. Remote transformer required (specify separately).

Housing

Die-cast aluminum housing with capacity for 1 LED, 3 LED, or ZDC integrated LEDs.

IES Classification

Type IV (RD & SQ), Type V (ST), Type II (WW).

Lens

Tempered glass lens with shock resistance and high tolerance for thermal expansion and stress.

Finish

Options of natural brass finish, antiqued finish with brushed (Antique Bronze) or tumbled (Antique Tumbled) effect, or TGIC powder-coat finish. Antique finishes sealed with a clear TGIC powder-coat layer.

Ambient Operating Temperature

0°F to 140°F (-18°C to 60°C)

Weight

3.6 lbs (1.6 kg)

Hardware

Includes 2" (51 mm) x 12" (305 mm) ABS conduit sleeve with ½"-14 NPT female hole for strain relief. Strain relief specified separately.

Control

ZD and ZDC options utilize Luxor Technology to zone light fixtures in up to 250 groups, dim each group in 1% increments between 0% and 100%, or change to one of 30,000 colors with RGBW LEDs. Select the ZD option for zoning/dimming or ZDC for zoning/dimming/color. Standard fixture is zoneable with a Luxor Controller.

Sustainability

Innovation meets conservation in the design and manufacturing of our products. Where we can, we use recycled materials while maintaining superior functionality. Our LED products provide high-quality light at optimal energy efficiency, lifespan, and durability.

Manufacturing

ISO 9001:2015 certified facility

Wildlife-Friendly Lighting

When used with the ZD3LEDT Output option, this fixture is Wildlife Lighting Certified by the Florida Fish and Wildlife Conservation Commission.

Installation Requirements

RD & SQ: Designed for recessed installation in a vertical wall in the down lighting position only.

WW: Designed for recessed installation in a vertical wall in any orientation.

ST: Designed for recessed installation in a vertical or horizontal wall; ensure substantial drainage flow for up lighting (e.g., decking).

International Compliance

Compliant per IEC 60598-1 and IEC 60598-2-4 when used with International Wall Light Connection Kit ("EKITWALL").

Listings



MO Recessed Wall Light ORDERING INFORMATION

Fixture	Luxor Option + Output	Faceplate	Finish
MO*	■ 1LED Zone, 60 lm	■ RD Round	■ BS Natural Brass
	■ 3LED Zone, 165 lm	■ SQ Square	■ BZ Bronze Metallic
	■ ZD3LED Zone/Dim, 3 LED, 165 lm	■ ST Spot	■ DG Desert Granite
	■ ZD3LEDT** Wildlife-Friendly Amber (585 to 595 nm)	■ WW Wall Wash	■ WI Weathered Iron
	■ ZDC Zone/Dim/Color, 90 lm		■ SB Sedona Brown
			■ FB Black
			■ FW Flat White
			■ SV Silver
			■ NP Nickel Plate
			■ AB Antique Bronze
			■ AT Antique Tumbled

EXAMPLE FIXTURE CONFIGURATION:

MO-ZDC-RD-SV

*Includes 2.0" (51 mm) Conduit Sleeve (250020600000).

** Available with ZD Luxor option and CU, AB, or AT finishes only.



ACCESSORIES: Specify Separately

Item	Code	
■ MOUNTING BRACKET FOR MO RECESSED WALL LIGHT 1.3" H x 3.2" W (33 mm x 81 mm)	MOBRKT	
■ STANDARD OPTICS KIT	ΔLEDOPTICKIT	
■ WALL LIGHT CONNECTION KIT	EKITWALL	

Δ = LED option

MO Recessed Wall Light PHOTOMETRICS

MO 1 LED Illuminance at a Distance		RD/SQ	
Feet (Meters)	Center Beam	Beam Width	
	Foot-Candles (Lux)	Vertical 45°	Horizontal 75°
0.5' (0.2 m)	16 fc (174 lx)	0.4' (0.1 m)	0.7' (0.2 m)
1.0' (0.3 m)	4 fc (43 lx)	0.8' (0.2 m)	1.5' (0.5 m)
1.5' (0.5 m)	1.8 fc (19 lx)	1.2' (0.4 m)	2.2' (0.7 m)
2.0' (0.6 m)	1.0 fc (11 lx)	1.6' (0.5 m)	3.0' (0.9 m)
2.5' (0.8 m)	0.6 fc (7 lx)	2.0' (0.6 m)	4.0' (1.0 m)

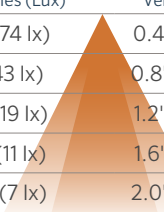

MO 1 LED Illuminance at a Distance		ST	
Feet (Meters)	Center Beam	Beam Width	
	Foot-Candles (Lux)	Vertical 90°	
0.5' (0.2 m)	136 fc (1,467 lx)	1.0' (0.3 m)	
1.0' (0.3 m)	34 fc (366 lx)	2.0' (0.6 m)	
1.5' (0.5 m)	15 fc (162 lx)	3.0' (0.9 m)	
2.0' (0.6 m)	9 fc (97 lx)	4.0' (1.2 m)	
2.5' (0.8 m)	4 fc (43 lx)	5.0' (1.5 m)	

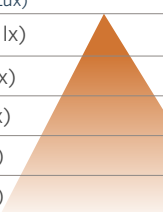

MO 1 LED Illuminance at a Distance		WW	
Feet (Meters)	Center Beam	Beam Width	
	Foot-Candles (Lux)	Vertical 50°	Horizontal 60°
0.5' (0.2 m)	33 fc (355 lx)	0.5' (0.2 m)	0.7' (0.2 m)
1.0' (0.3 m)	8 fc (86 lx)	1.0' (0.3 m)	1.3' (0.4 m)
1.5' (0.5 m)	4 fc (43 lx)	1.5' (0.5 m)	2.0' (0.6 m)
2.0' (0.6 m)	2 fc (22 lx)	2.0' (0.6 m)	2.6' (0.8 m)
2.5' (0.8 m)	1.3 fc (14 lx)	2.4' (0.7 m)	3.3' (1.0 m)

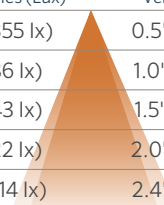

MO 3 LED Illuminance at a Distance		RD/SQ	
Feet (Meters)	Center Beam	Beam Width	
	Foot-Candles (Lux)	Vertical 40°	Horizontal 60°
0.5' (0.2 m)	33 fc (355 lx)	0.4' (0.1 m)	0.6' (0.2 m)
1.0' (0.3 m)	8 fc (86 lx)	0.8' (0.2 m)	1.0' (0.4 m)
1.5' (0.5 m)	4 fc (43 lx)	1.0' (0.4 m)	2.0' (0.6 m)
2.0' (0.6 m)	2 fc (22 lx)	2.0' (0.5 m)	3.0' (0.8 m)
2.5' (0.8 m)	1.3 fc (14 lx)	2.0' (0.6 m)	3.0' (0.8 m)

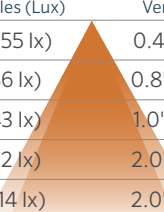

MO 3 LED Illuminance at a Distance		ST	
Feet (Meters)	Center Beam	Beam Width	
	Foot-Candles (Lux)	Vertical 85°	
0.5' (0.2 m)	355 fc (3,821 lx)	1.0' (0.4 m)	
1.0' (0.3 m)	89 fc (958 lx)	2.0' (0.5 m)	
1.5' (0.5 m)	39 fc (424 lx)	3.0' (0.9 m)	
2.0' (0.6 m)	22 fc (239 lx)	4.0' (1.2 m)	
2.5' (0.8 m)	14 fc (153 lx)	5.0' (1.5 m)	

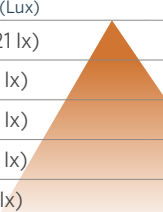

MO 3 LED Illuminance at a Distance		WW	
Feet (Meters)	Center Beam	Beam Width	
	Foot-Candles (Lux)	Vertical 50°	Horizontal 70°
0.5' (0.2 m)	88 fc (946 lx)	0.5' (0.2 m)	0.7' (0.2 m)
1.0' (0.3 m)	22 fc (237 lx)	1.0' (0.3 m)	1.3' (0.4 m)
1.5' (0.5 m)	10 fc (106 lx)	1.5' (0.5 m)	2.0' (0.6 m)
2.0' (0.6 m)	6 fc (59 lx)	2.0' (0.6 m)	2.5' (0.8 m)
2.5' (0.8 m)	4 fc (38 lx)	3.0' (0.9 m)	3.0' (0.8 m)

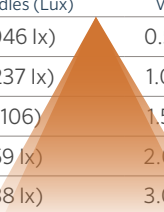

MO Recessed Wall Light PHOTOMETRICS

MO zDC Illuminance at a Distance		RD/SQ	
Feet (Meters)	Center Beam	Beam Width	
	Foot-Candles (Lux)	Vertical 45°	Horizontal 70°
0.5' (0.2 m)	24 fc (262 lx)	0.4' (0.1 m)	0.7' (0.2 m)
1.0' (0.3 m)	61 fc (655 lx)	0.8' (0.2 m)	1.0' (0.4 m)
1.5' (0.5 m)	2.7 fc (29 lx)	1.2' (0.4 m)	2.0' (0.6 m)
2.0' (0.6 m)	1.5 fc (16 lx)	1.6' (0.5 m)	3.0' (0.9 m)
2.5' (0.8 m)	0.97 fc (10 lx)	2.0' (0.6 m)	3.0' (0.9 m)

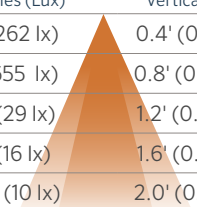

MO zDC Illuminance at a Distance		ST
Feet (Meters)	Center Beam	Beam Width
	Foot-Candles (Lux)	Vertical 90°
0.5' (0.2 m)	268 fc (2,885 lx)	1.0' (0.4 m)
1.0' (0.3 m)	67 fc (721 lx)	2.0' (0.6 m)
1.5' (0.5 m)	30 fc (321 lx)	3.0' (0.9 m)
2.0' (0.6 m)	17 fc (181 lx)	4.0' (1.2 m)
2.5' (0.8 m)	11 fc (115 lx)	5.0' (1.5 m)

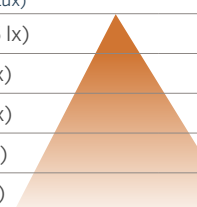

MO zDC Illuminance at a Distance		WW	
Feet (Meters)	Center Beam	Beam Width	
	Foot-Candles (Lux)	Vertical 40°	Horizontal 70°
0.5' (0.2 m)	83 fc (895 lx)	0.4' (0.1 m)	0.7' (0.2 m)
1.0' (0.3 m)	21 fc (224 lx)	0.8' (0.2 m)	1.0' (0.4 m)
1.5' (0.5 m)	9 fc (99 lx)	1.0' (0.4 m)	2.0' (0.6 m)
2.0' (0.6 m)	5 fc (56 lx)	2.0' (0.6 m)	3.0' (0.9 m)
2.5' (0.8 m)	3 fc (36 lx)	2.0' (0.6 m)	4.0' (1.0 m)

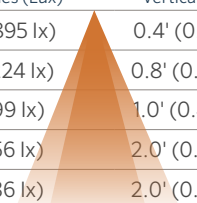

Lumileds is a trademark of Lumileds Holding B.V. MoistureBlock is a trademark of DSM&T Co. Inc.

© 2021 Hunter Industries™. Hunter, FX Luminaire, all related logos, and all other trademarks are property of Hunter Industries, registered in the U.S. and other countries.