

TECHNICAL SPECIFICATIONS GUIDE

For Installation of Custom Water Features



March 2020

PLEASE READ THIS!

This Custom Cascade Technical Manual is provided to ensure that you have the tools needed to correctly determine the right feature for your client, understand the options available to you, and know what the requirements are so that the finished product looks and sounds as beautiful as what you had originally conceptualized.

While Custom Cascade offers the best products and effects possible, the finished result relies largely on planning and installation — this is why we ask that you, the professional, take a moment to thoroughly review this guide for all pertinent details and requirements before installing our products.

If you're unsure about any of the information provided, need additional details, or want to confirm accuracy, please don't hesitate to contact a member of our educated staff — we're happy to assist in ensuring that both you and your clients are happy with the products and finished effects. We would prefer to communicate with you as often as needed versus having a product out there that you or your client are unhappy with.

If what you're looking for is outside of the guidelines you see in this manual, please contact us directly. We welcome the challenge of your custom creation. With our years of experience and fabrication capabilities — the possibilities are practically as limitless as your imagination.

This Guide Contains:

- Important Facts
- How-To's
- Common Questions
- Technical Reference Material
- Spec's, Flow Charts, Radius Guides

The Smart Choice

- Custom Cascade is the original manufacturer of the sheeting waterfall.
- We have the largest variety of standard water features in the industry.
- We are the only manufacturer to offer products in ABS plastic or pure metal.
- We offer four colors of ABS plastic: white, gray, tan, and clear.
- Our metal waterfalls are available in Stainless Steel, Copper, or Brass.
- Metal units use our exclusive Free-Flow baffle system to eliminate potential internal blockages.
- ABS units feature a T-Baffle design that adds additional structural support.
- Our special order capabilities are almost limitless.
- Our staff is educated and ready to assist you.

Frequently Asked Questions:

What size pump do I need?

There are many variables that are involved in determining the correct pump size, such as distance from the pump to the water feature, pipe size, number of 90 degree angles in the plumbing, etc. We can tell you the gallons per minute (gpm) that our water features require which varies from 5 gpm to 30 gpm. Please refer to the flow charts provided on pages 13 to 15 to determine the G.P.M. required for your application.

How do I figure the radius?

The radius is calculated by taking the diameter of a circle and dividing it in half. We can also calculate the radius by using the straight edge measurements from point to point of the front of the water feature and the measurements of the greatest difference from the center of the feature. If this information is not available or the radius is compound, a template can be made of paper or cardboard and submitted to us for calculation. Refer to "How to Cut a Template" on the "On-Site Construction Know How" (Page 6).

What is the largest water feature you can make?

Our metal and ABS water features can be made to any length including straight, radius, curved vessels, or compound radius units. Challenge us!

How many inlets are on the water feature?

There are many variables to this question, such as what type of water feature you are purchasing, length, desired effect, etc.. Please refer to the inlet charts provided on pages 16 and 17 for the answers.

Can a water feature be lit?

Yes. We recommend using RainFalls or RainCurtains for the best effect, since disrupted water reflects light much better. Water features are best accented by using up lighting 12" to 18" below the water, or down lighting from the underside of the fall. Both options are made possible by using either fiber optics, LED or incandescent products.

Can an ABS plastic water feature be painted?

While an ABS water feature can be painted, we feel choosing either a tan or gray color is the most simple, permanent and affordable solution to blending the water feature into the pools environment. If you choose to paint, epoxy works best. Be aware that like any other painted surface, it will require maintenance.

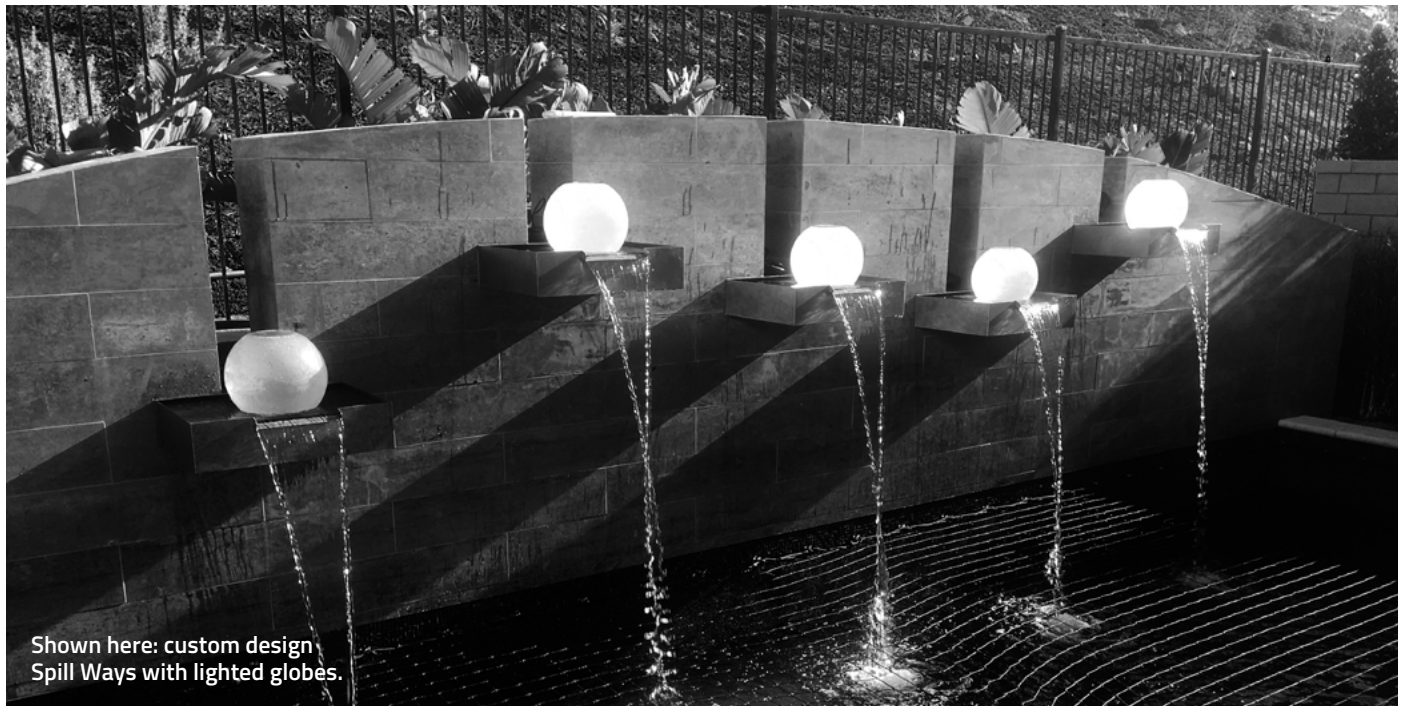

Remember the information contained in this guide is designed to be used as a guideline only. Your specific projects may need additional analysis.

Avoiding Problems...

- It's important to know the correct gpm required for your application. More water, valved, is always better than not enough water. See flow charts provided in this reference guide for details (Page 13 to Page 15).
- Always blow the lines clear of debris before attaching the water features.
- When cutting a waterfall on site, follow "How to Cut a Perfect Radius" instructions completely on Page 6.
- DO NOT leave plastic water features in direct sunlight or hot temperatures. If needed, see "On-Site Construction Know How" for details on repairing a warped waterfall (Page 6).
- Know the maximum elevations at which water features can maintain a sheeting fall before the water breaks up. See "Flow Charts" provided for details (Page 13 to Page 15).
- Know your radius and the lip requirements. See "Radius Lip Sizing Chart" for details (Page 9).

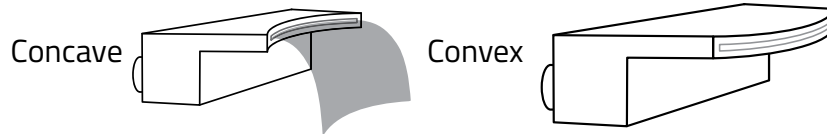

- Do not install stainless steel units in pools or water features with salt chlorine generators. We recommend copper, brass or ABS plastic. See page 23 of this guide for warranty requirements.
- Keep debris off all waterfalls, especially stainless steel. Surface debris can settle and cause rust if left unattended. See "Owners Guide to Caring For Your Water Feature" instructions. (Page 5)
- Provide the consumer with information in regards to the variety of sounds different water features make; sheeting vs. rain, etc.. Choose a location that makes best use of natural sunlight to capture that shimmering look.
- Provide the home owner with the instruction sheet included with each water feature.

Common Requests

Creating a Wet-Wall Effect:

There are many variables to creating a wet-wall effect. The most important factor is knowing the desired effect of water flow, range from a smooth, almost splashless sheet to a rushing flow of white water. In all applications, a leak-proof, even disbursement of water at the top of the fall is a basic requirement. To keep the water on the surface of the wall, the water manifold should be installed 1/2" to 1" behind the surface wall. This also keeps the water supply hidden. Water flow requirements range from 3 gpm to 7 gpm in most applications. Textured surfaces will need to be reclined at 3 ° to 7 ° to keep the water in contact with the surface. No matter how rough the surface, the water will not run "white" until it gets up to speed, approximately 8" from the top of the fall.

Calculating Basin Size:

7.5 gallons of water fits in one foot of space. One cubic foot of space is calculated by 12" x 12" x 12" = 1728". The general rule for required water in the reservoir tank is 3 times the amount of the water needed to make the waterfall function properly. For example, if the waterfall needs 30 gpm, then the reservoir tank must hold 90 gallons of water.

Example: Take 90 gallons, then divide by 7.5 = 12 cubic feet of space needed in the basin to operate correctly.

Reservoir length must be 2' longer than the waterfall (12" on each side).

Width of reservoir must be 1/2 the height of the waterfall. For example if a 4' waterfall is placed 4' up, the reservoir must be minimum of 8' long and 2' wide. (front to back).

Calculating Water Capacity in a Basin:

Lets say we have a reservoir tank that measures 12" H x 7" W x 48" L (you must convert all measures to inches).

1. Multiply 12 x 7 x 48 = 4032 cubic inches.

2. Divide that by 1728 (one cubic foot)

3. Equals 2.33 cubic feet in this case.

4. 7.5 gallons fits in one cubic foot so 7.5 x 2.33 = 17.475 gallons fits in that size of reservoir tank.

Converting a Waterfall to a RainFall:

It is possible to convert some plastic waterfalls to rainfalls after installation?

For complete details and assistance contact our customer service department at cs@oreqcorp.com or call 800-420-3255. Dial Opt. 2.

Remember this is basic information designed to be used as a guideline only. Your specific job needs may vary.

Owners Guide To Caring For Your Water Feature

Custom Cascade Waterfall Maintenance

To ensure that the water flowing to your water feature is clean and clear of debris, be sure that your pool filter is kept clean.

For ABS Plastic Units:

For perfect sheet like flow, keep debris out of lip area. If the water flow becomes broken, chances are some type of debris is lodged in the front of the lip area. Simply use the enclosed rock pick or a credit card and slide it across the front of the fall. Be careful to avoid hitting the support ribs that are set 3/4" back from the lip opening. Ribs must be kept straight and in place for appropriate flow

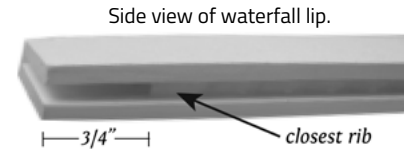

For Metal Units:

Our **stainless steel** units are made with the highest grade of metal available. To keep debris from settling on the lip area, the waterfalls should be wiped down with a clean cloth periodically. When minerals or chemicals settle on the unit over a period of time, surface rust may develop. If this occurs, a Scotch-Bright® pad can be used to rub it off. It is important to use long, single strokes, parallel to the lip. This process may dull a stainless steel brushed finish, leaving a pewter type look. It will not compromise the quality of the metal.

Our **copper and brass** waterfalls are made with pure high quality metal. It is natural for these metals to patina or change surface colors over time. You may see browns, greens, blue or even purple colors in a large variety of patterns. This distinctive and exquisite look will continue to change over time. If you choose to keep the brushed metal look (no patina) you can do so by using a Scotch-Bright® pad. Again, even strokes, staying parallel with the lip. As with any metal, the results of a polish/patina will create a variety of effects based on the grade of the cloth or scrubbing pad and the amount of pressure applied.

Your water feature is designed with little to no maintenance in mind. It is our hope that you and your family enjoy the soothing sounds and find its shimmering water playful and inviting.

We sincerely hope your water feature brings you and your family refreshing fun and beauty for your pool. Our family has been in the swimming pool industry for over 40 years. It's our experience and attention to detail that creates the finest quality products for your swimming pool.

Visit www.oreqcorp.com for information on all our products including Stinger™, Animal™ Pro, Custom Cascade™, Fire Designs™, Scent-trific™ with Chlorine Plus™, PoolPals™, Clear Spa 104™ and ClearView™. You will find unique items, all made with quality and high standards you can count on.

Please remember to always enjoy your swimming pool safely. Never leave any child unattended even for a moment.

42306 Remington Avenue, Temecula, CA 92590
Phone 800-420-3255 Fax 800-434-7660

On-Site Construction Know-How

How To Cut a Perfect Radius:

(ABS plastic waterfalls 2000 series and higher only)

1. Use #10 coarse-tooth jigsaw blade for initial cut. Make the cut quickly to avoid melting the ABS plastic.
2. Smooth out with hand plane.



(sold at hardware stores, looks like a cheese grater)

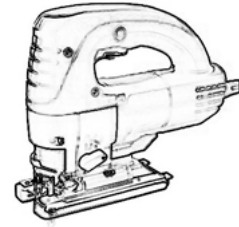

3. Support ribs should be set 3/4" back from the lip edge. Each rib is designed to break off in 1/2" sections. Using the rib tool (slot side), remove the rib section closest to the lip by grasping the end of the rib and gently move it left to right, until a 1/2" section breaks off.



Rib Tool

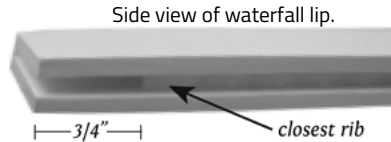

Side view of waterfall lip.

3/4"

closest rib

4. Finish with 80 grit sand paper, clean any debris from the lip area.
5. Quickly swab front of lip with appropriate glue solvent to seal.
6. If you should need to replace any broken ribs, they can be re-set inside the lip using the rib tool and glue. Ribs MUST be set straight and square for appropriate flow.



Note: Modifications or damage to a water feature void all conditions of warrant. See warranty section for full conditions.

How to Make a Template for Radius Cuts:

1. Use paper or cardboard for best results.
2. Lay material down FLAT on top of area for waterfall placement.
3. Using a permanent marker, carefully draw a line where the edge of waterfall is to lay.
4. Mark template with an arrow showing direction of water flow. Write "top" on the template that represents the top of the waterfall unit.
5. Mail to: Oreq Corporation, Attn: Custom Cascade Sales, 42306 Remington Ave., Temecula, CA 92590.

If Your Waterfall Gets Warped From Heat/Sun Exposure:

1. Expose the water feature to heat/sun again to soften plastic.
2. When unit is warm, remove from sun or heat source.
3. Immediately distribute weight across the top of the waterfall. A good method is to cover the top of the waterfall with cement blocks. Allow to cool overnight.
4. Once the waterfall is back in shape, cover and store in a cool place until ready to install.

Note: Modifications or damage to a water feature void all conditions of warrant. See warranty section for full conditions.

Remember this is basic information designed to be used as a guideline only. Your specific job needs may vary.

Custom Cascade Water Feature Style Chart

Products below are be available in ABS Plastic or Metal, unless otherwise indicated.

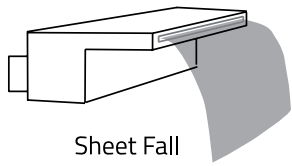

Sheet Fall

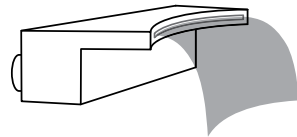

Sheet Fall Radius

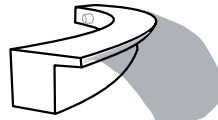

Sheet Fall Curved Vessel



Sheet Fall Compound Radius

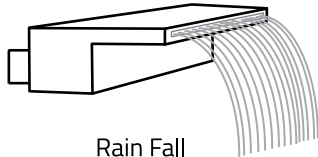

Rain Fall

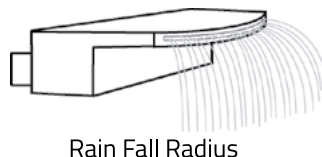

Rain Fall Radius

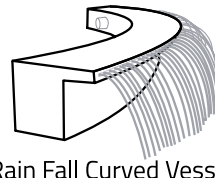

Rain Fall Curved Vessel



Rain Fall Compound Radius

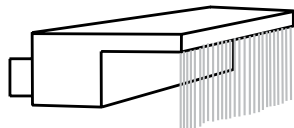

Rain Curtain

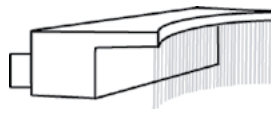

Rain Curtain Radius

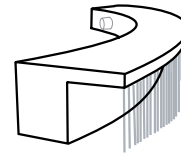

Rain Curtain Curved Vessel

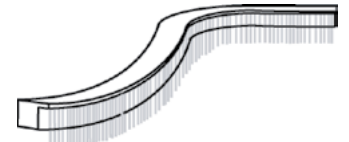

Rain Curtain Compound Radius

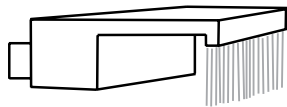

Rain Curtain 90 Degree

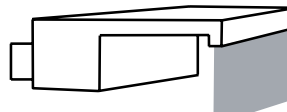

Curtain Fall 90 Degree

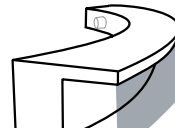

Curtain Fall Curved Vessel



Curtain Fall Compound Radius

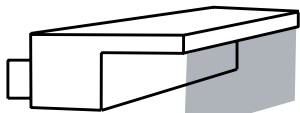

Curtain Fall

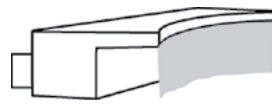

Curtain Fall Radius

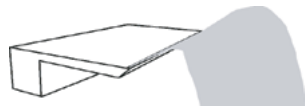

Arc Fall

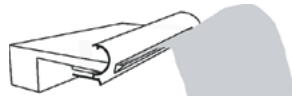

Plastic Arc Fall Vinyl

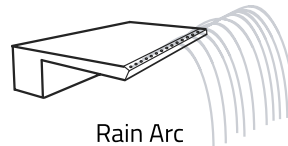

Rain Arc



Plastic Rain Arc - Vinyl

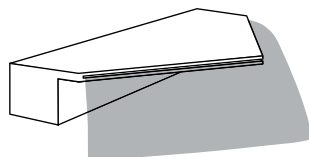

Corner Fall

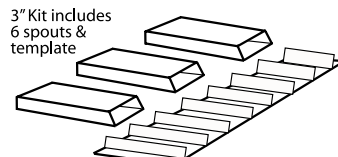

3" Kit includes
6 spouts &
template

Channel Spouts 3"

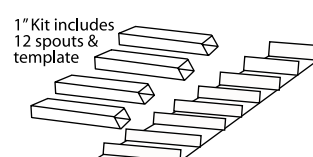

1" Kit includes
12 spouts &
template

Channel Spouts 1"



Channel Spout

Continued on the next page.

Custom Cascade Water Feature Style Chart Cont..

All products below are available in Stainless Steel, Copper or Brass..



Spill Way



Radius Spill Way



Channel Spout

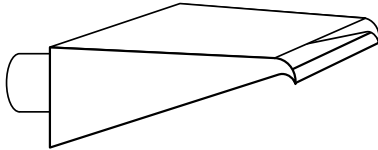

Scupper

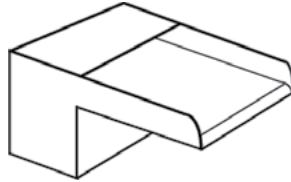

OpenTop Sheet Fall



Radius Spill Edge

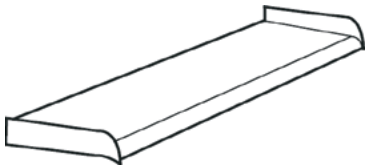

Spill Edge

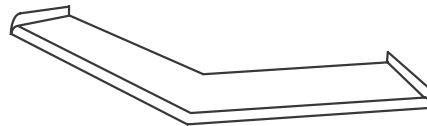

Corner Spill Edge

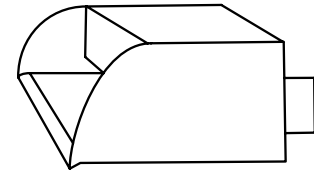

Step Scupper

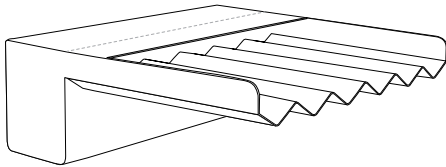

River Fall

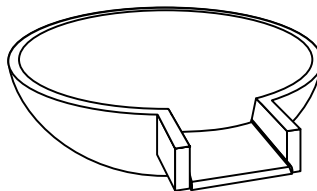

Round Urn
(Recommended SpillEdge)

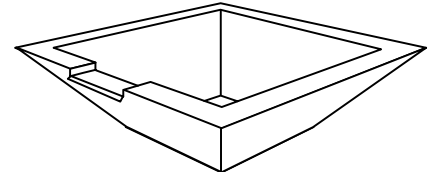

Square Pot
(SpillEdge recommended)

Radius Waterfall - Lip Sizing Chart

Waterfall Length

	1'	1.5'	2'	3'	4'	5'	6'	7'	8'
1'	6" Lip	12" Lip	n/a	n/a	n/a	n/a	n/a	n/a	n/a
1.5'	6" Lip	6" Lip	12" Lip	n/a	n/a	n/a	n/a	n/a	n/a
2'	6" Lip	6" Lip	6" Lip	12" Lip	n/a	n/a	n/a	n/a	n/a
2.5'	6" Lip	6" Lip	6" Lip	12" Lip	n/a	n/a	n/a	n/a	n/a
3'	6" Lip	6" Lip	6" Lip	12" Lip	12" Lip	n/a	n/a	n/a	n/a
3.5'	6" Lip	6" Lip	6" Lip	12" Lip	12" Lip	n/a	n/a	n/a	n/a
4'	6" Lip	6" Lip	6" Lip	6" Lip	12" Lip	n/a	n/a	n/a	n/a
4.5'	6" Lip	6" Lip	6" Lip	6" Lip	12" Lip	12" Lip	n/a	n/a	n/a
5'	6" Lip	6" Lip	6" Lip	6" Lip	12" Lip	12" Lip	n/a	n/a	n/a
5.5'	6" Lip	6" Lip	6" Lip	6" Lip	12" Lip	12" Lip	n/a	n/a	n/a
6'	6" Lip	6" Lip	6" Lip	6" Lip	12" Lip	12" Lip	12" Lip	n/a	n/a
6.5'	6" Lip	6" Lip	6" Lip	6" Lip	6" Lip	12" Lip	12" Lip	n/a	n/a
7'	6" Lip	6" Lip	6" Lip	6" Lip	6" Lip	12" Lip	12" Lip	n/a	n/a
7.5'	6" Lip	6" Lip	6" Lip	6" Lip	6" Lip	12" Lip	12" Lip	n/a	n/a
8'	6" Lip	6" Lip	6" Lip	6" Lip	6" Lip	12" Lip	12" Lip	12" Lip	n/a
8.5'	6" Lip	6" Lip	6" Lip	6" Lip	6" Lip	12" Lip	12" Lip	12" Lip	n/a
9'	6" Lip	6" Lip	6" Lip	6" Lip	6" Lip	12" Lip	12" Lip	12" Lip	n/a
9.5'	6" Lip	6" Lip	6" Lip	6" Lip	6" Lip	12" Lip	12" Lip	12" Lip	n/a
10'	6" Lip	6" Lip	6" Lip	6" Lip	6" Lip	6" Lip	12" Lip	12" Lip	n/a
10.5'	6" Lip	6" Lip	6" Lip	6" Lip	6" Lip	6" Lip	12" Lip	12" Lip	12" Lip
11'	6" Lip	6" Lip	6" Lip	6" Lip	6" Lip	6" Lip	12" Lip	12" Lip	12" Lip
11.5'	6" Lip	6" Lip	6" Lip	6" Lip	6" Lip	6" Lip	12" Lip	12" Lip	12" Lip
12'	6" Lip	6" Lip	6" Lip	6" Lip	6" Lip	6" Lip	12" Lip	12" Lip	12" Lip
12.5'	6" Lip	6" Lip	6" Lip	6" Lip	6" Lip	6" Lip	12" Lip	12" Lip	12" Lip
13'	6" Lip	6" Lip	6" Lip	6" Lip	6" Lip	6" Lip	12" Lip	12" Lip	12" Lip
13.5'	6" Lip	6" Lip	6" Lip	6" Lip	6" Lip	6" Lip	12" Lip	12" Lip	12" Lip
14'	6" Lip	6" Lip	6" Lip	6" Lip	6" Lip	6" Lip	6" Lip	12" Lip	12" Lip

Radius Size

Examples of Radius Lips On Water Features

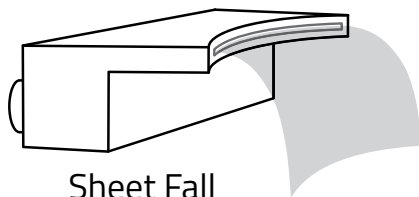

Sheet Fall
Concave Radius

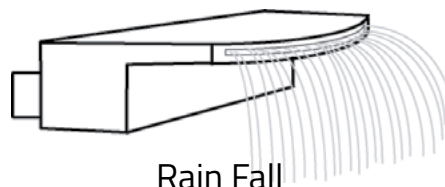

Rain Fall
Convex Radius

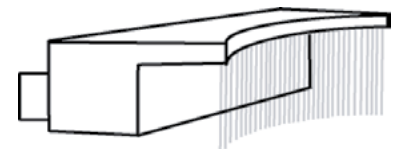

Rain Curtain
Concave Radius

Custom Cascade Specification Guide - Plastic

Specs provided are for "standard" units and may vary slightly. Custom orders are always welcome.

Sheet Fall & Rain Fall

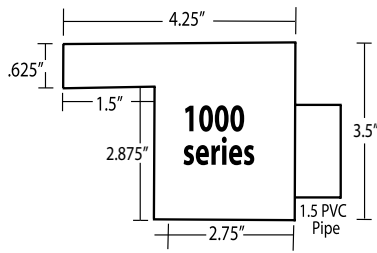

Rain Curtain, Curtain Fall

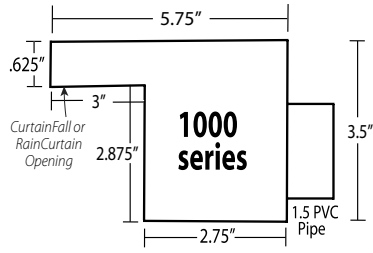

Curtain Fall 90, Rain Curtain 90

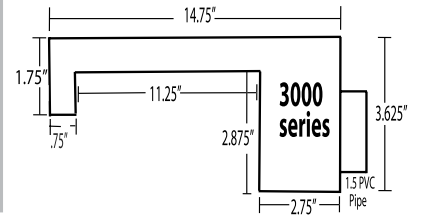
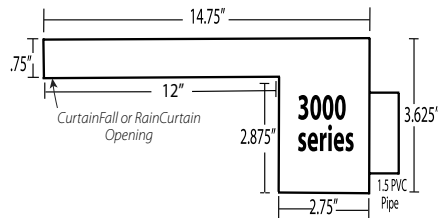
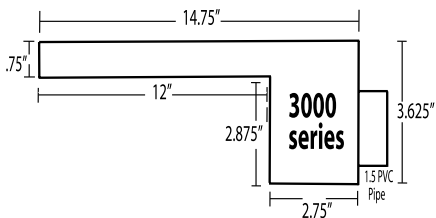
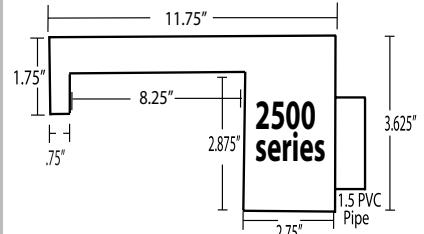
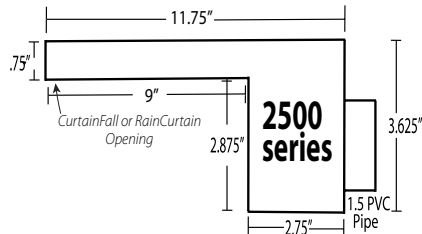
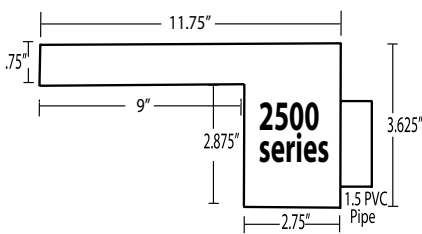
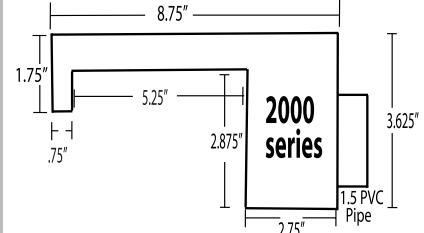
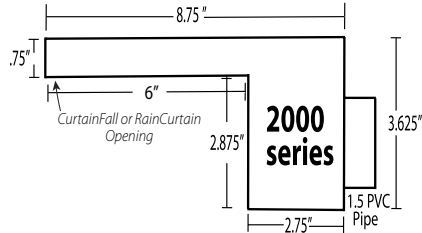
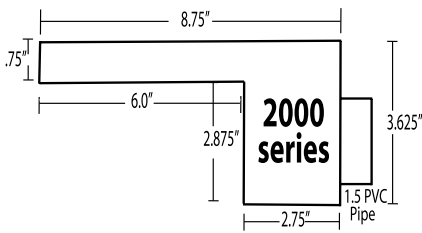
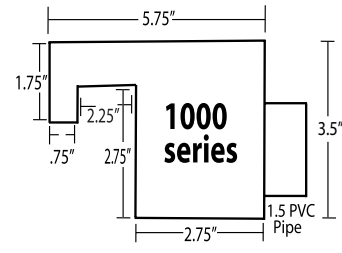

Arc Fall

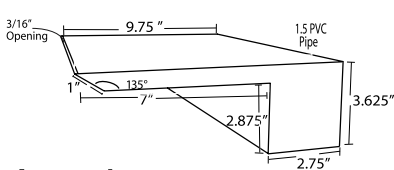

Rain Arc

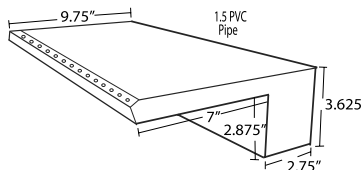

Arc Fall/Rain Arc Vinyl Application

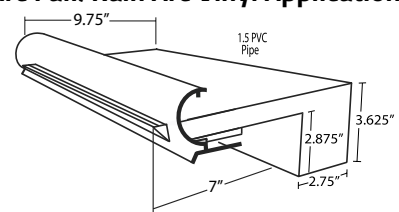

Channel Spouts

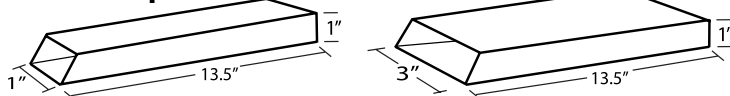

Standard Colors

Tan, Gray or Clear Custom color: White

Opening Specs:

1000 Series Waterfall - 1/8"
2000, 2500 & 3000 Series Waterfalls - 1/4"

Hole pattern options for Rain Falls, Rain Curtains, Rain Curtain 90, and Rain Arcs*

1" Spacing	• • • •
1/2" Spacing	• • • • • • • •
* 1/2" Spacing Offset	• • • • • • • •

Holes are 5/32" D.
Set back 3/8" from front of lip.

*Not available for RainArc

Remember this is basic information designed to be used as a guideline only. Your specific job needs may vary.

Custom Cascade Specification Guide - Metal

Specs provided are for standard units and may vary slightly. Custom orders are always welcome.

Sheet Fall

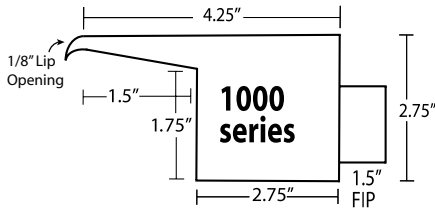

Rain Fall

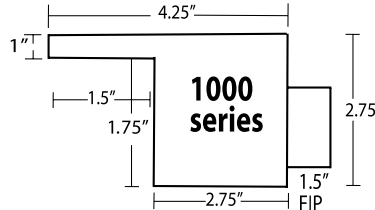

Hole pattern options for Rainfalls, RainCurtains, RainCurtain 90's, and CurtainFall 90's

1" Spacing	•	•	•	•	•
1/2" Spacing	•	•	•	•	•
1/2" Spacing Offset	•	•	•	•	•

Holes are 3/16"

Sheet Fall

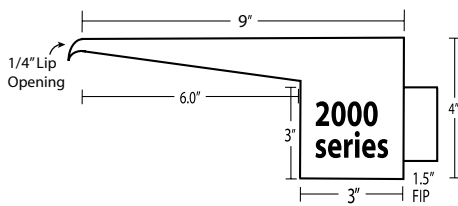

Rain Fall, Rain Curtain, Curtain Fall

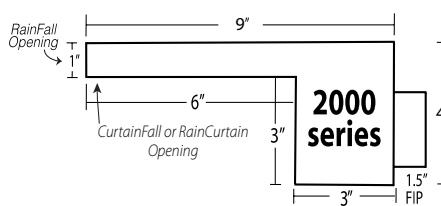

Curtain Fall 90, Rain Curtain 90

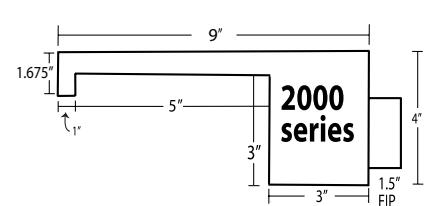

Sheet Fall

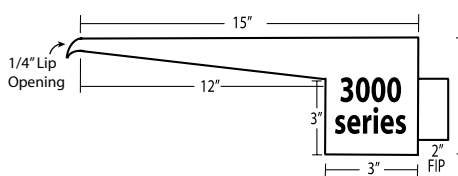

Rain Fall, Rain Curtain, Curtain Fall

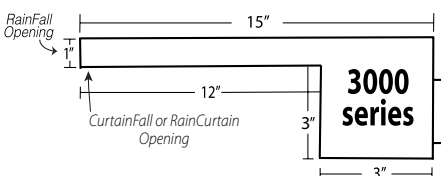

Curtain Fall 90, Rain Curtain 90

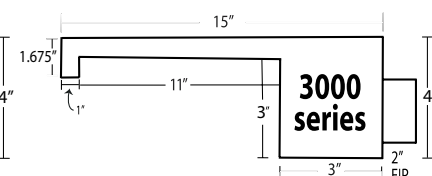

Open Top Sheet Fall

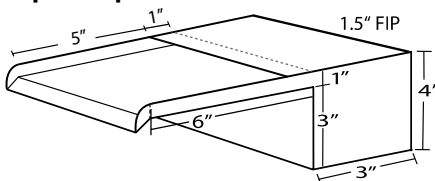

Spill Edge

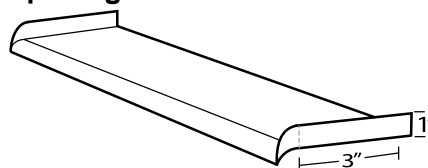

Spill Way

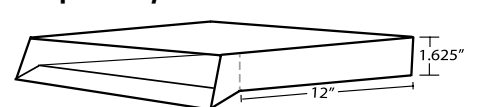

Step Scupper

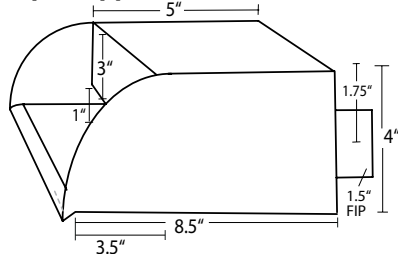

Scupper

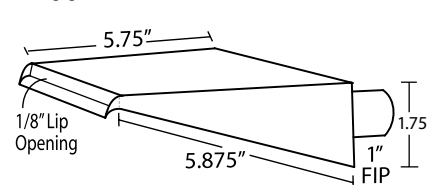

Channel Spouts

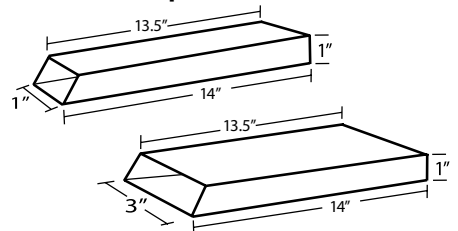

River Fall

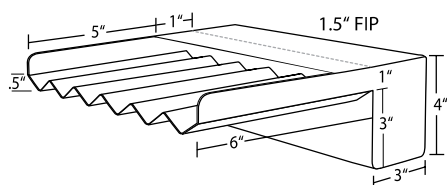

Material Specs:

Stainless Steel - .078"
 Brass - .096"
 Copper - .0625"
 2000 and 3000 Metal Box
 Dimensions are 3" x 4".

Opening Specs:

1000 Series Waterfall - 1/8"
 2000 & 3000 Series Waterfalls - 1/4"
 No Drip Lips - 30° 5/8" over-hang

REGAL ACCENTS SPECIFICATION GUIDE

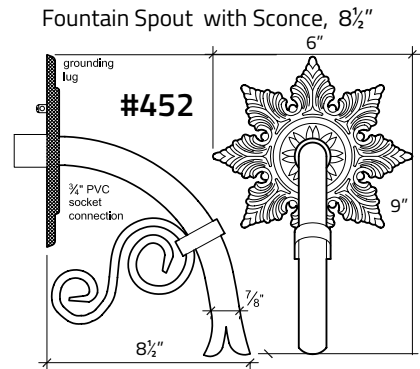
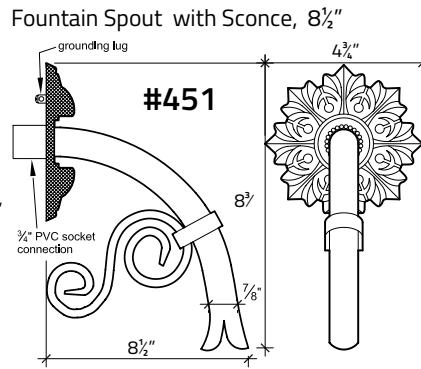
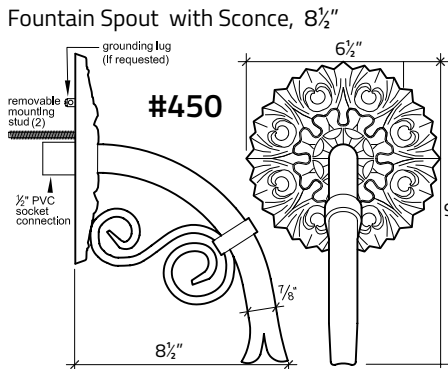
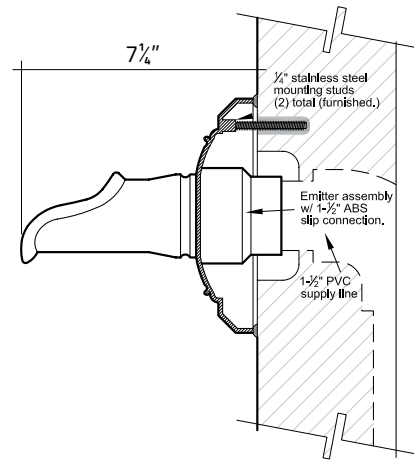
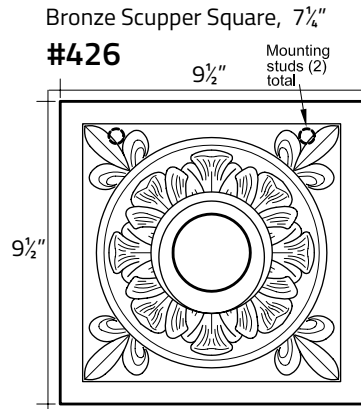
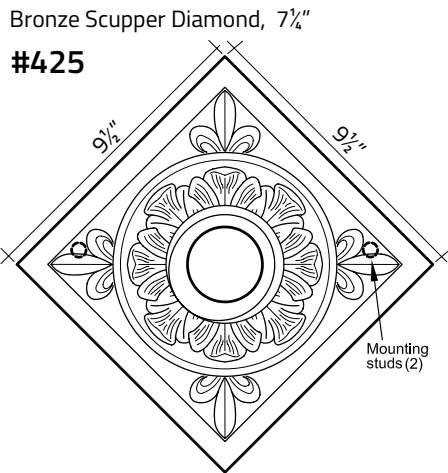
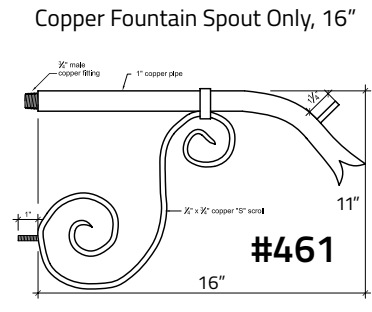
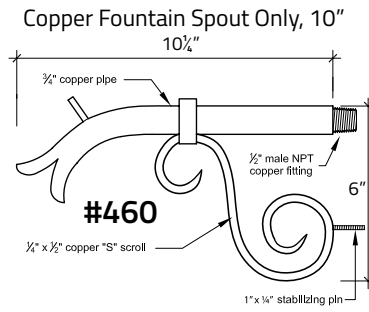
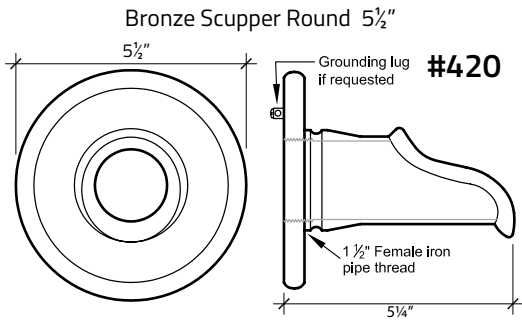

Remember this is basic information designed to be used as a guideline only. Your specific job needs may vary.

Custom Cascade Flow Charts

1000, 2000, and 3000 Sheet Fall Series

Recommended gallons per minute: 1000 Series - 10gpm, 2000 Series - 20gpm, 3000 Series - 30gpm.

Metal Series

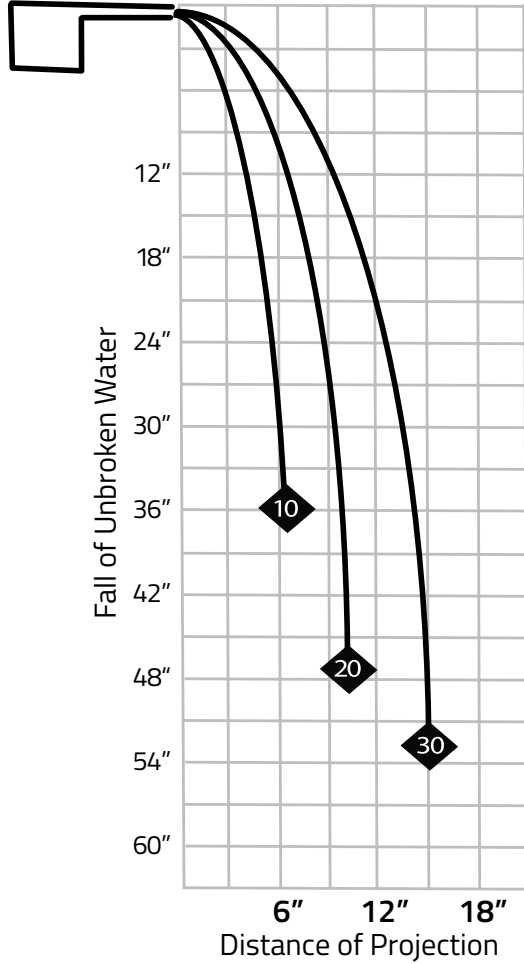

Plastic Series

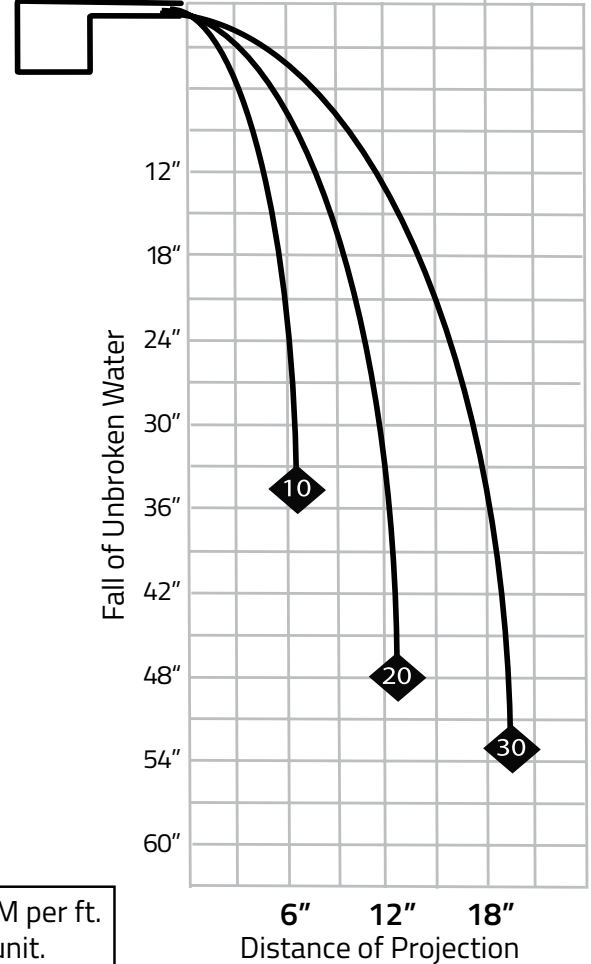

These flow charts reflect approximate sheeting and projections of water based on gallons per minute (GPM) per foot of waterfall length. Water flow will vary with weather conditions, project design, and overall hydraulics.

Arc Fall Series

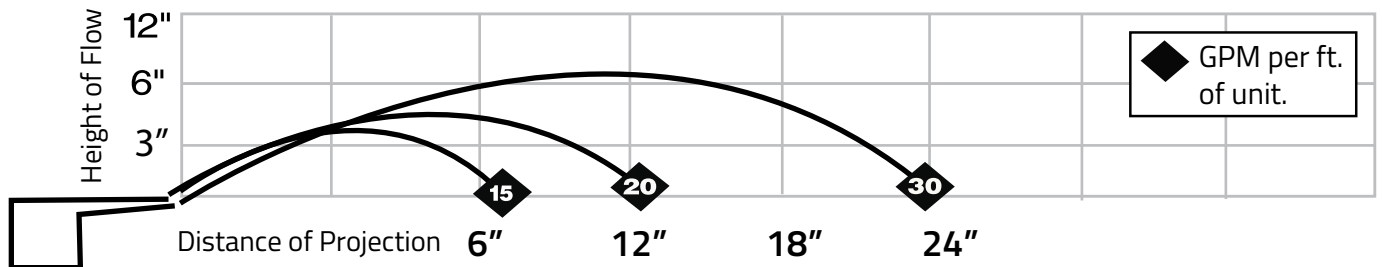

Custom Cascade Flow Charts

1000, 2000, 2500, and 3000 Rain Falls or Curtain Falls - Plastic or Metal

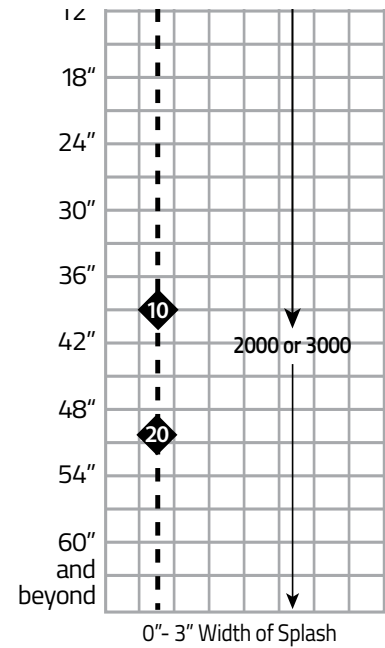
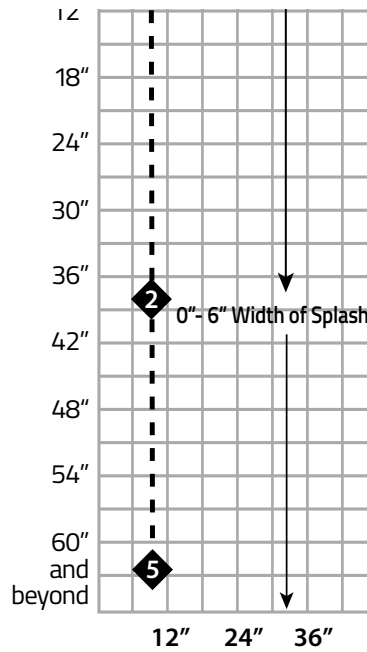
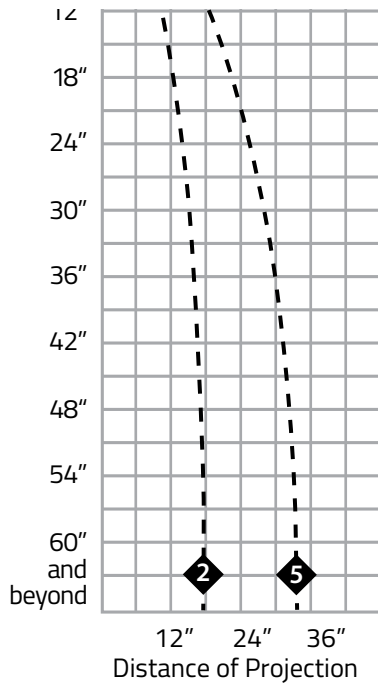

*Calculations for BOTH the straight and 90 degree lip.

These flow charts reflect approximate sheeting and projections of water based on gallons per minute (GPM) per foot of waterfall length. Water flow will vary with weather conditions, project design and overall hydraulics.

RainArc Series

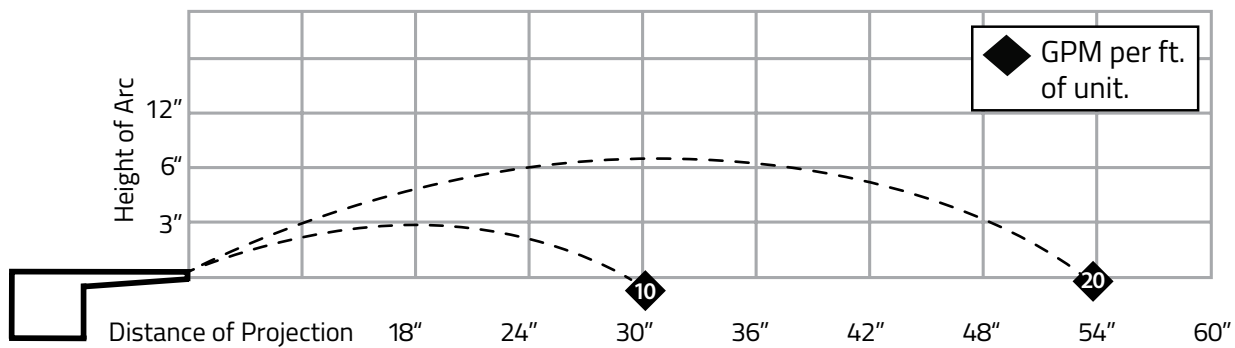

Remember this is basic information designed to be used as a guideline only. Your specific job needs may vary.

Custom Cascade Flow Charts

Step Scupper & Standard Scupper

Available In Metal Only

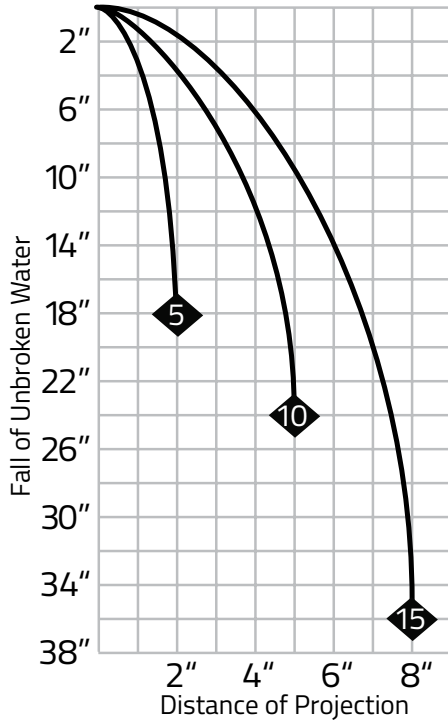

◆ GPM per ft. of unit.

These flow charts reflect approximate sheeting and projections of water based on gallons per minute (GPM) per foot of waterfall length. Water flow will vary with weather conditions, variance of water pressure, and overall hydraulics.

3" Channel Spout

Available In Metal & ABS

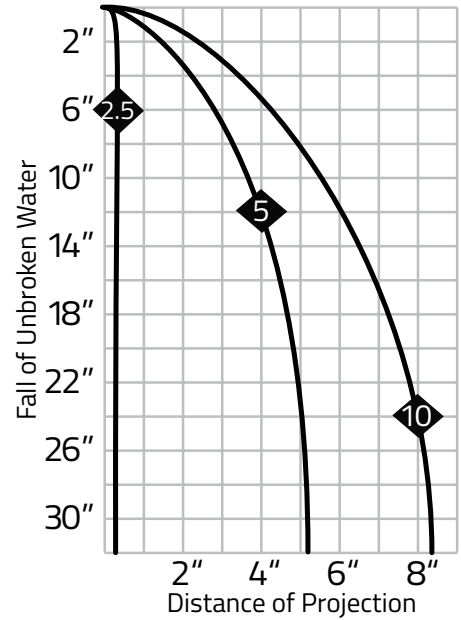

Open Top Sheet Fall

Available In Metal Only

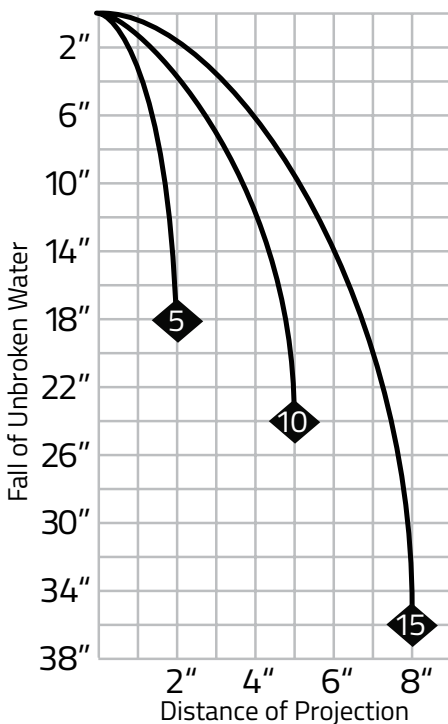

12" SpillEdge

Available In Metal Only

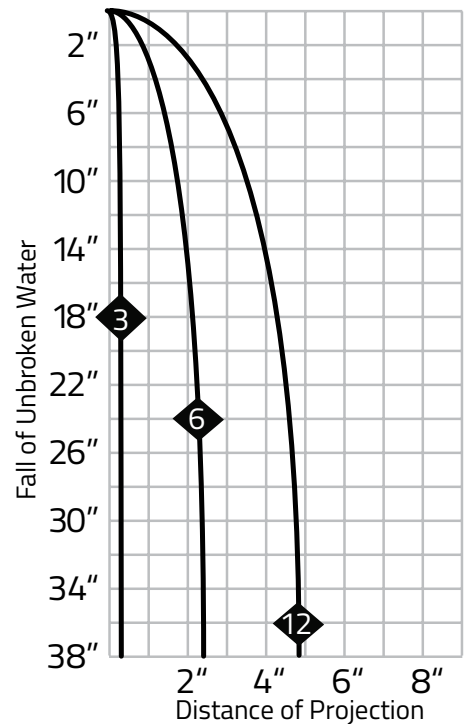

ABS Plastic Water Feature Inlet Spacing Chart

Back Inlet - 1.5" PVC Pipe (standard)
 1000 Series - 1.5" Lip, 1/8" opening
 2000 Series - 6" Lip, 1/4" opening
 2500 Series - 9" Lip, 1/4" opening
 3000 Series - 12" Lip, 1/4" opening

Bottom Inlet - 1.5" PVC Pipe (standard)
 1000 Series - 1.5" Lip, 1/8" opening
 2000 Series - 6" Lip, 1/4" opening
 2500 Series - 9" Lip, 1/4" opening
 3000 Series - 12" Lip, 1/4" opening

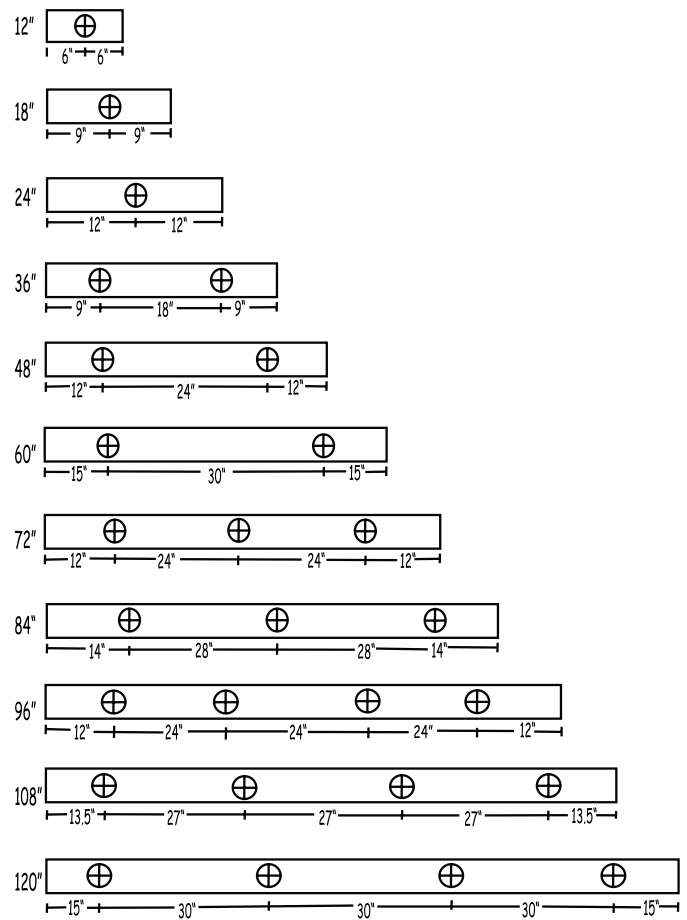
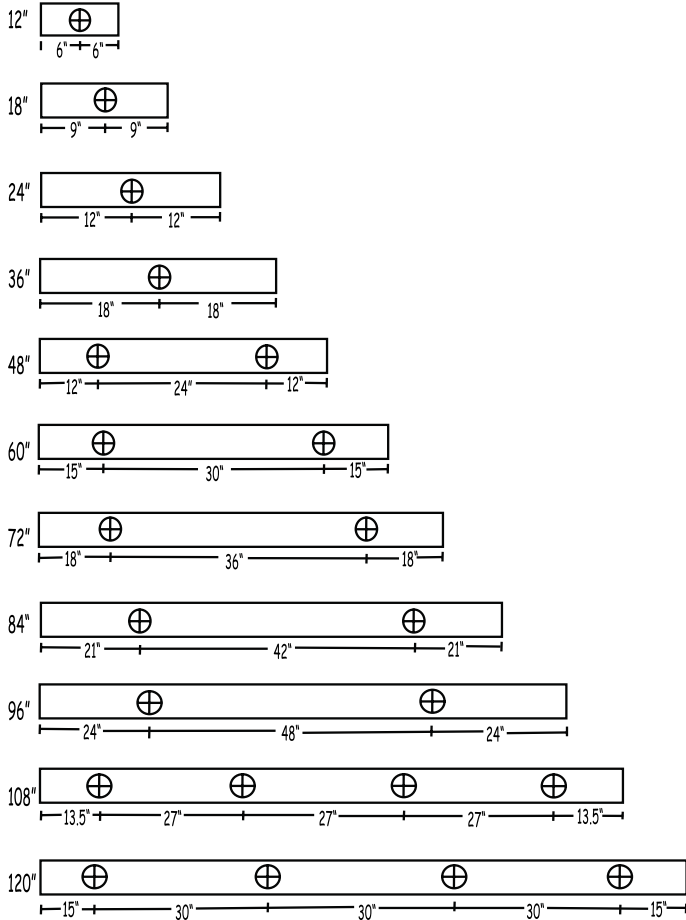

Arc Fall & Rain Arc

Back or Bottom Inlet - 1.5" PVC Pipe (standard)

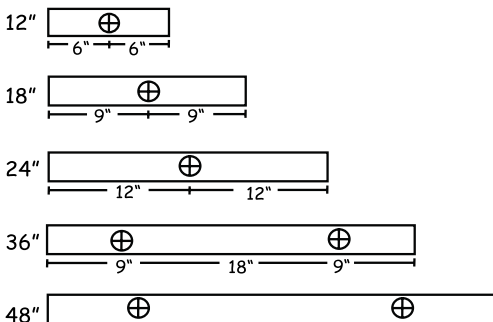

Remember this is basic information designed to be used as a guideline only. Your specific job needs may vary.

Metal Water Feature Inlet Spacing Chart

1000 Series - 1.5" Lip, 1/8" Opening, Back or Bottom Inlet
1.5" FIP (back is standard)

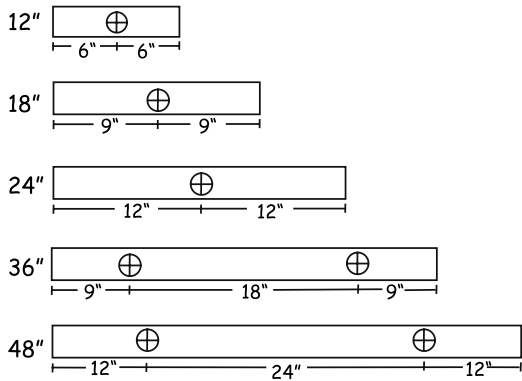

2000 Series - 6" Lip, 1/4" Opening, Back or Bottom Inlet
1.5" FIP (back is standard)

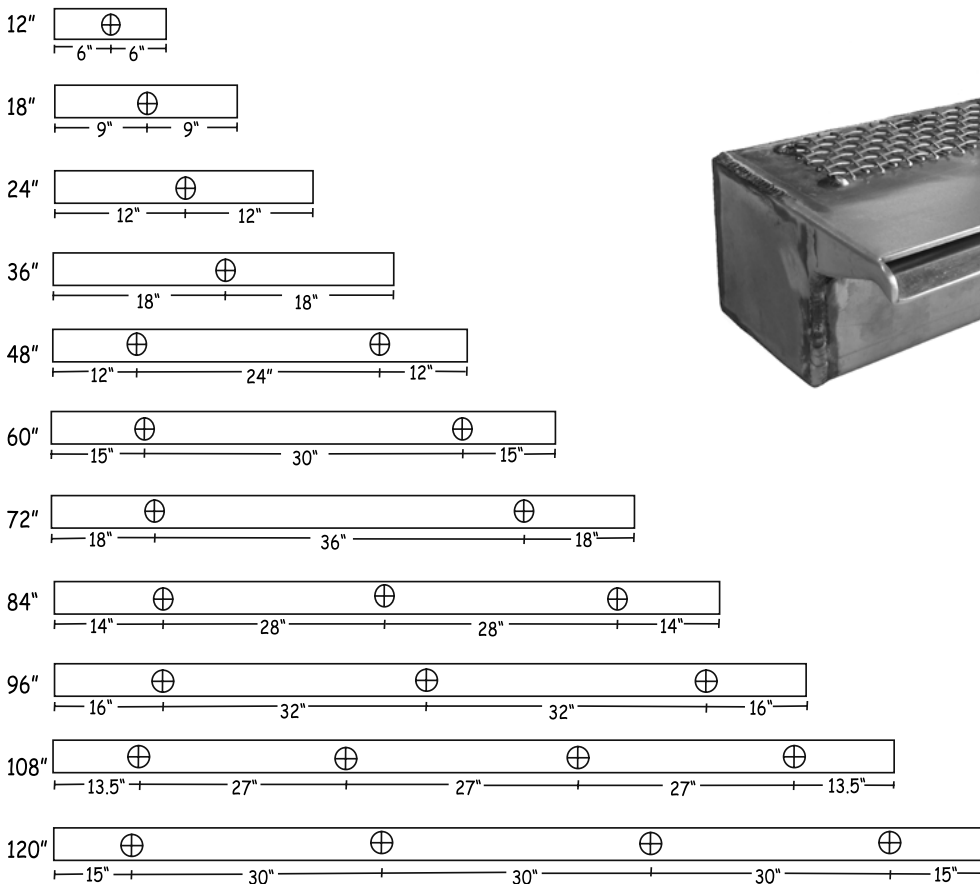

Metal Sheetting Waterfall

3000 Series Metal Inlets are 2" FIP

Up to 2' will have a single inlet, centered. 3' up to 10' will be spaced 12" from each end, then 2' on center.

Spill Edge Installation

READ ALL INSTRUCTIONS FIRST!

Adherence to the following instructions will ensure that you have a trouble free installation of your Custom Cascades Spill Edge. Installation must be made according to manufacturer's recommendations for warranty to be valid. If you need assistance during installation, please call Oreq Corporation 1.800.420.3255.

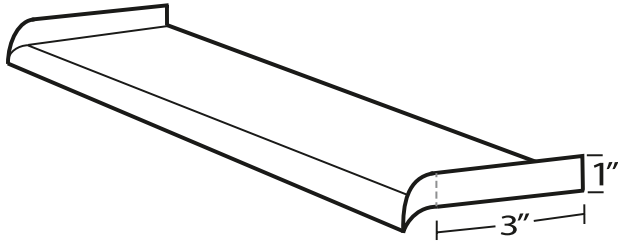

A Spill Edge is designed to facilitate the flow from a raised body of water to a lower body of water. An ideal application is from a raised spa to a swimming pool below. It can be used in place of the leading edge of tile and may be custom made to virtually any desired specifications.

STEP 1. PREPARE THE BEAM

Select the desired location for installation. Make sure the surface is clean and free of debris. Check that the Spill Edge is sized correctly for the location and that it fits properly. If the unit is made on a radius, be sure that the unit follows the correct surface curvature. Also ensure that the ground wire is long enough to reach the bonding lug provided.

STEP 2. SETTING THE SPILL EDGE IN PLACE

Attach the ground wire to the Spill Edge. Apply a layer of Thinset tile mortar about 1/4" thick to the leading edge of the bond beam. Place the flat area of the Spill Edge down into the Thinset, leaving the "No Drip Lip" hanging past finished wall. The wire mesh on the bottom of the Spill Edge should be encased in the Thinset mortar. Level the Spill Edge.

When more than one Spill Edge is installed in line, it is important that they all be at the same elevation to ensure an even flow over each.

BE SURE THAT THE LIP IN FRONT OF THE SPILL EDGE IS MOUNTED TO BE PAST THE PLANNED FINISHED WALL SURFACE. THE SHEET OF WATER WILL NOT BREAK OVER THE SPILL EDGE IF THE LIP IS TOO FAR BACK.

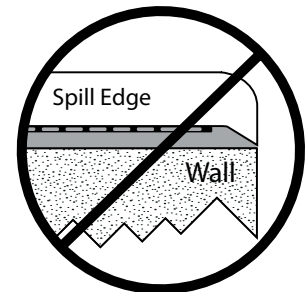
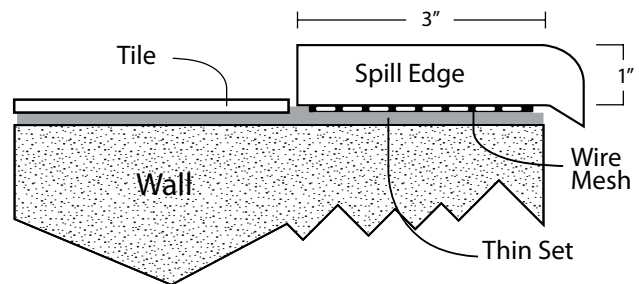

STEP 3. FINISHING

Install tile up to Spill Edge allowing for a grout joint. When plastering pool, double check to make sure Spill Edge is covered so that no plaster will get on the surface of the metal.

A 3M Scotch Brite pad may be used to clean Spill Edges with a brush finish, brushing in long even strokes parallel with the lip. This process will expose the fresh metal. Oxidizing of brass and copper Spill Edges is to be expected.

Adjust the water flow valve(s) for desired effect.

WARRANTY:

It is Oreq's policy to replace or credit our customer for defective parts returned due to workmanship or material failure during the first year of sale. Prior factory approval is required for returns, along with original receipt. Failure to follow manufacture recommended instructions for installation and/or care, voids all warranties. Oreq Corporation is not responsible for cost of removal of product, or installation of replacement unit. Oreq is not responsible for shipping to or from facility, or damage done by shipper.

WARNING: Refer back to page 4 on "Avoiding Problems" and the Warranty statements at the back of this document.

Arc Fall/Rain Arc Installation: Guniting Application

READ ALL INSTRUCTIONS FIRST!

Adherence to the following instructions will ensure that you have a trouble free installation of your Custom Cascades SpillEdge. Installation must be made according to manufacturer's recommendations for warranty to be valid. If you need assistance during installation, please call Oreq Corporation 1.800.420.3255.

BEFORE YOU BEGIN, it is important to know the appropriate GPM requirements for your specific water feature. You will need to calculate head loss, pump sizing, and plumbing to meet these requirements. Remember, more water with a valve is better than not enough.

STEP 1. NOTCHING THE BOND BEAM

- Select the desired location for installation. Bend steel reinforcement to allow for installation of the ArcFall/RainArc manifold.
- Notch the bond beam or wall low enough to allow the face of the ArcFall/RainArc (the front opening) to finish 1/2" more than the entire overhang of the coping. For example, if coping material cantilevers out 2" the ArcFall/RainArc needs to be 2 1/2" below the bottom of the coping.
- Leave enough room at face of ArcFall/RainArc for any finishing materials, plus an extended 1/4" at top of ArcFall/RainArc opening.

STEP 2. PLUMBING

The plumbing lines must be blown clean of debris **BEFORE** attaching the water feature. The water supply to the manifold **MUST** be filtered between the pump and water feature.

- Connect a length of standard 1 1/2" schedule 40 PVC piping approximately 12" long (to extend in back of pool wall) and glue into PVC male adapter on the back of the waterfall manifold.
- When plumbing multiple units, it is important to install a two-way valve for each waterfall unit to be installed. The use of multiple valves allows the flow rate to be balanced for each unit. Valves should be positioned near the water feature in a standard covered deck box for easy accessibility.
- Freeze protection can be achieved by plumbing the unit so water drains easily from the system. For winterizing, blow lines and follow normal procedure.

STEP 3. SETTING ARC FALL/RAIN ARC MANIFOLD

- Mask out any areas that will be exposed on the finished unit to protect from getting mortar or Thinsset inside. On ABS units, leave the protective lip insert in place, if included.
- Set manifold in place with mortar, **MORTAR BACK AND BOTTOM ONLY**.
IMPORTANT: Adjust front of lip to desired position of finished wall inside pool. Be sure to leave adequate space to accommodate a 1/4" overhang beyond finished wall.
- Level ArcFall/RainArc manifold.
- To help secure the waterfall in position until concrete is dry, cover finished setting with 1/2" x 3/4" plywood. Place bricks or a cinder block on top of the plywood to distribute weight evenly over the waterfall manifold and the bond beam.

STEP 4. FINISHING

- Remove protective plywood cover and install mortar, coping (brick, etc). Take caution to keep all concrete away from ArcFall/RainArc lip area. Be sure the finished wall surface is 1/4" behind waterfall lip edge.
- Once concrete has cured, you may remove any masking tape and the protective insert from the ArcFall/RainArc lip. After start up, you may use a credit card or similar item to clean debris that may have fallen into the lip area. Gently slide card along the opening while the ArcFall/RainArc is running. Do not use sharp objects such as hacksaw blade, knife etc. Sharp objects may cause damage to the lip and or support ribs inside the unit and affect the ArcFalls/RainArcs performance. Gently pull out any debris in the lip opening area out.
- Adjust the valve(s) for desired effect. When more than one ArcFall/RainArc has been installed, adjust each valve until proper effect and balance are achieved.

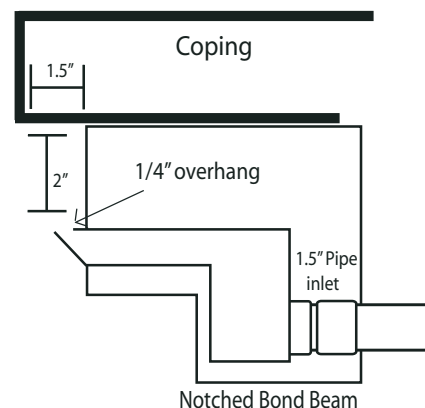

Arc Fall/Rain Arc Installation: Vinyl Application

READ ALL INSTRUCTIONS FIRST!

Adherence to the following instructions will ensure that you have a trouble free installation of your Custom Cascades Spill Edge. Installation must be made according to manufacturer's recommendations for warranty to be valid. If you need assistance during installation, please call Oreq Corporation 1.800.420.3255.

- Arc Fall/Rain Arc units designed for vinyl Deck Form applications are sold as kits that include:
- (A) Unit with attached mounting plate
 - (B) Pre-Cut, custom fit, deck form section
OR pre-cut CP2 coping
 - (C) Hardware - self tapping screws (not shown)

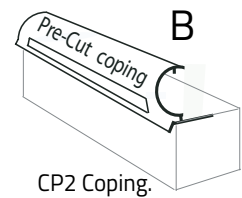
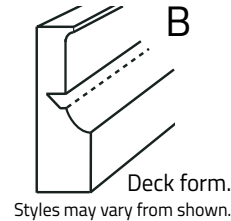
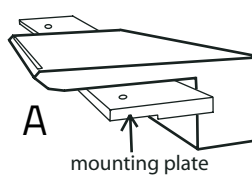

STEP 1. MOUNTING ARC FALL/RAIN ARC AND FORM

NOTE: When setting deck forms, always attach liner track according to deck form manufactures instructions. Before proceeding, it is recommended that you set the water feature wall form section(s) first.

- A. Secure provided, pre-notched deck form in desired waterfall location.
- B. Cover lip opening and any any area that will be exposed after installation with low residue masking tape to keep any debris from entering unit during construction. Protect the entire area, including plumbing, from bearing any type of heavy weight or getting debris trapped inside.

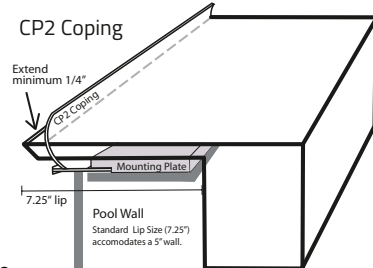
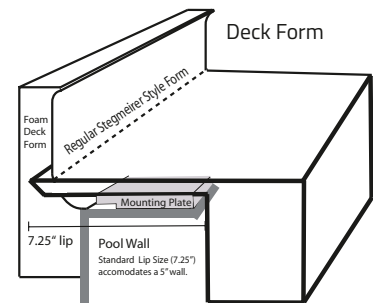

Deck Form Applications

- C. Set unit mounting plate on wall in desired location, but DO NOT SECURE. Mounting plate is step-cut to fit flat against liner track. Unit will set 1.5" beyond the pool wall.
- D. Securely place the notched deck form over the extended portion of unit lip. Remove attachment tape from deck form. Snap the tabs into liner track per deck form manufacture's instructions.

For CP2 Applications

- C. Attach pre-cut CP2 coping to pool wall.
- D. Insert the water feature unit through the opening of coping. The lip opening of the unit MUST be entirely exposed through the pre-cut opening to prevent blockage of flow. Mounting plate is step-cut to fit flat against liner track.

- E. Using the pre-drilled holes on the mounting plate, secure unit to wall with the self tapping screws provided.
- F. Attach remaining deck forms per manufacture's instructions. It is recommended that you finish with the two deck forms that will attach to either side of the ArcFall/RainArc section.

STEP 2. PLUMBING

Plumbing line must be blown clean of debris BEFORE attaching water feature.
Water supply to manifold MUST be filtered between pump and water feature.

- A. Connect a length of standard 1½" schedule 40 PVC piping approximately 12" long (to extend in back of pool wall) and glue into PVC male adapter on the back of the waterfall manifold.
- B. When plumbing multiple units, it is important to install a two way valve for each individual waterfall unit. The use of multiple valves allows the flow rate to be balanced for each unit. Valves should be positioned near the water feature in a standard covered deck box for easy accessibility.
- C. Freeze protection can be achieved by plumbing the unit so water drains easily from the system. For winterizing, blow lines and follow normal procedure.

STEP 3. FINISHING

- A. Finish concrete deck per manufacturer's instructions, including removal of forms. Use trowel provided by form manufacturer to finish coping edge. Take caution to keep all concrete away from the Arc Fall/Rain Arc lip area.
- B. Once concrete has cured you may remove the masking tape from the unit lip. After start up, use a credit card or similar item to clean debris that may have fallen into the lip opening. Gently slide card along the opening while the unit is running. Do not use sharp objects such as hacksaw blade, knife etc. Sharp objects may cause damage to the lip and/or support ribs inside the unit and affect the units performance. Gently pull out any debris in the lip opening area.
- C. Adjust the valve(s) for desired effect. When more than one unit has been installed, adjust each valve until proper flow and balance are achieved.

Waterfall Installation For Plastic and Metal Waterfall Manifolds

READ ALL INSTRUCTIONS FIRST!

Adherence to the following instructions will ensure that you have a trouble free installation of your Custom Cascades Spill Edge. Installation must be made according to manufacturer's recommendations for warranty to be valid. If you need assistance during installation, please call Oreq Corporation 1.800.420.3255.

IMPORTANT! PLASTIC Falls should be kept from direct sunlight!

Do not remove protective grout guard from plastic falls until installation is complete. For metal falls, cover lip with masking tape.

BEFORE YOU BEGIN, it is important to know the appropriate GPM requirements for your specific water feature. You will need to calculate head loss, pump sizing, and plumbing to meet these requirements. Remember, more water with a valve is better than not enough.

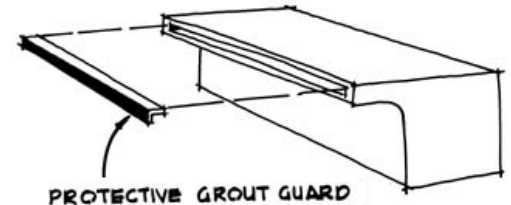

STEP 1. NOTCHING THE BOND BEAM

A. Select the desired location for installation. Bend steel reinforcement to allow for installation of the waterfall manifold.

B. Mark a channel for the plumbing to the waterfall: Before concrete hardens, a notch must be cut into the bond beam where the steel reinforcement has been offset to clear bottom of manifold.

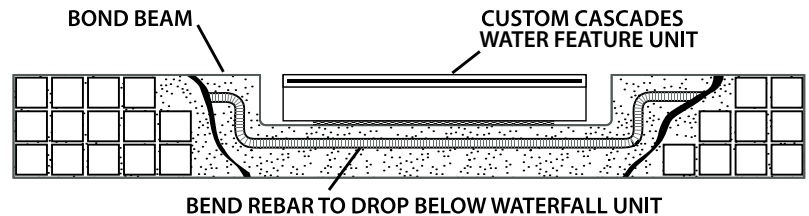

First, mark the notch in the front side of the bond beam to be cut $3\frac{3}{4}$ " deep. Cut the notch for the manifold 2" longer than the length of the waterfall to be installed and allow a maximum of 5" in the notch for the manifold and lip. Complete concrete work.

Bond Beam Notch Options for Water Feature Types

1. For standard waterfall manifolds with a single PVC connection on the back: Mark and cut one slot in the center of the bond beam $3\frac{3}{4}$ " deep and $2\frac{1}{2}$ " wide extending through the entire bond beam.

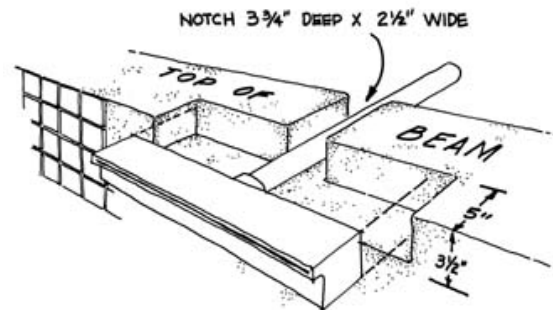
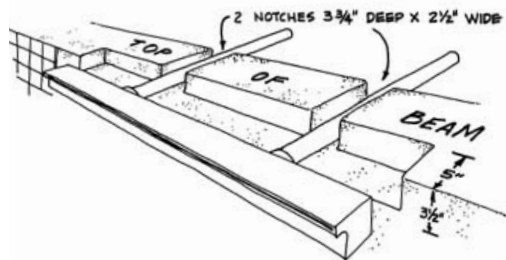

2. For standard waterfall manifolds with two or more connections on the back: Hold manifold in position over the bond beam and mark location of each inlet. Cut slots to size as shown here at the left.

3. Installation for extended or radius cut waterfall manifolds is simpler than single or double inlets. Mark notch for the manifold on the backside of the bond beam and follow the same directions as (1) and (2) above.

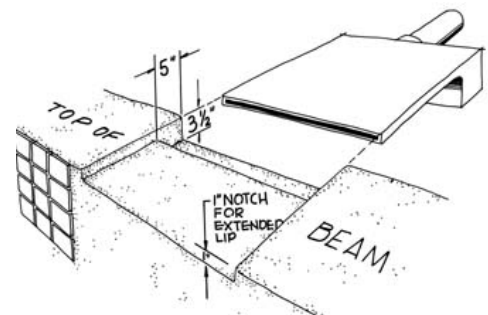

Remember this is basic information designed to be used as a guideline only. Your specific job needs may vary.

Installation For Plastic and Metal Waterfall Manifolds continued.

Cutting the lip for radius installation of plastic extended lip waterfall.

(Refer to Page 6 for additional tips and techniques.)

WARNING:

Radius cuts, other than those manufactured by Custom Cascade, will void any and all product warranties. Custom Cascade does not recommend that user cut a radius or any other such cut. Custom Cascade has both concave and convex radius cuts available as well as other customized options. For further information, contact Custom Cascade at 800.420.3255.

The plastic extended lip waterfall can be cut to form convex or concave curves. To custom fit your waterfall, determine the amount of the extended lip you wish to remove and mark with pencil. Remember to leave enough lip to allow for mortar and tile. When cutting a radius the remaining lip must **not** be less than 1.5" in length from the body of the fall at any point.

Before cutting the waterfall, remove the grout guard from the lip. Cut the extended lip with a coarse tooth jig saw. Make your cut as smoothly and quickly as possible to avoid a rough edge or possible melting. After completing the cut, grab the rib sections with rib tool (provided with waterfall) and carefully rock from side to side break off 1/2" to 1" of rib sections. This will allow the water to rejoin into a sheet. Remove the loose rib sections from the waterfall lip. Smooth the surface with a sanding block and a coarse grade of sandpaper, then finish with a fine grade sandpaper. Place the protective grout guard back into the lip.

STEP 2. SETTING WATERFALL MANIFOLD IN PLACE

- Connect a 1 1/2" coupling and a length of standard 1 1/2" schedule 40 PVC piping approximately 12" long (to extend beyond back of bond beam) and glue into slip joint inlet on the back of the waterfall manifold. This will allow you to complete mortar set now and complete plumbing later.
- Set manifold in place with mortar, **MORTAR BACK AND BOTTOM ONLY**.
IMPORTANT: Adjust front of lip to desired position of finished wall inside pool.
- Level waterfall manifold.
- To help secure the waterfall in position until concrete is dry, cover finished setting with 1/2" or 3/4" plywood. Place bricks or a cinder block on top of the plywood to distribute weight evenly over the waterfall manifold and the bond beam. Keep the waterfall covered to protect it from heat or direct sunlight as this may warp the plastic.

***IMPORTANT:** This procedure must always be followed when installing all waterfalls.

Stainless Steel Manifold Placement

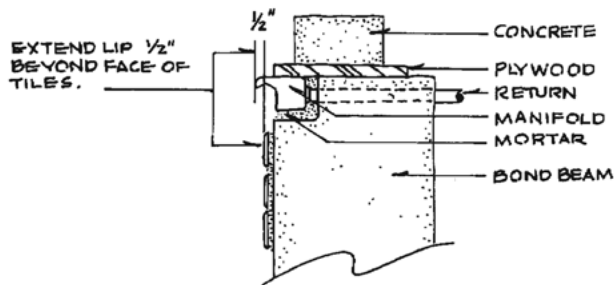

1000 Series ABS Manifold Placement

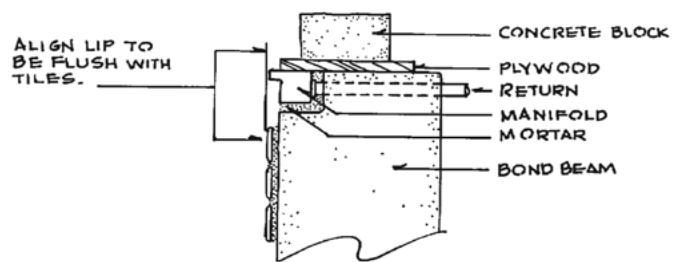

Extended Lip ABS Manifold Placement

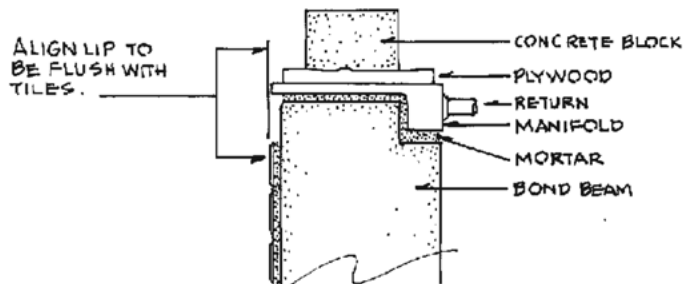

Installation For Plastic and Metal Waterfall Manifolds continued.

FREEZE PROTECTION

Winterizing and freeze protection can be achieved by plumbing the unit so water drains easily from the system. For winterizing, blow lines and follow normal procedure.

!IMPORTANT!
Plumbing line must be blown clean of debris **BEFORE** attaching water feature.
Water supply to manifold **MUST** be filtered between pump and water feature.

STEP 3. PLUMBING

Plumbing Multiple Units – Plumbing two or more units together is done using the same procedure as for a single unit waterfall. The difference is the installation of an in-line two-way valve for each individual waterfall unit. The use of multiple valves allows the flow rate to be balanced for each specific unit. Valves should be positioned near the bond beam in a standard covered deck box for easy accessibility. When installing two or more units, it is recommended that the same water feature models are used.

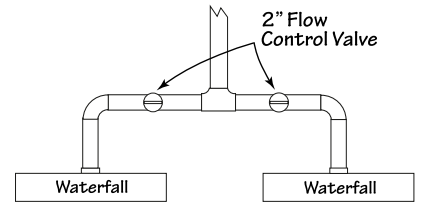

Plumbing with 2 or more inlets is done by using a loop configuration as shown here on the right.

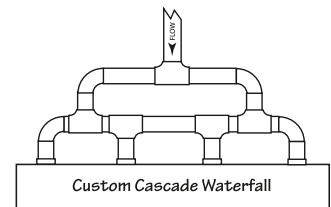

STEP 4. FINISHING

Install coping – remove protective plywood cover and install mortar, coping (brick, etc.). When plastering pool, double check to make sure the protective grout guard or masking tape is in place so that no plaster will get inside the waterfall lip. After all concrete, plaster and grout work is completed, you may remove the grout guard or masking tape from the lip of the manifold.

Be sure no debris is lodged in the opening of the waterfall. To clean the opening, use a credit card or similar object and gently slide along the opening while the waterfall is on. Do not use sharp edged objects (i.e., hacksaw blades, knives, etc.). The misuse of such objects can affect the waterfall performance. If you encounter an obstruction, gently pull it outward through the opening.

Adjust the valve(s) for desired effect. When more than one waterfall has been installed, adjust each valve until proper flow and balance are accomplished.

WARRANTY & DISCLAIMER

This Custom Cascade Technical Manual is provided to ensure that you have the tools needed to correctly determine the right feature for your client, understand the options available to you, and know what the requirements are so that the finished product looks and sounds as beautiful as what you had originally conceptualized.

While Custom Cascade offers the best products and effects possible, the finished result relies largely on planning and installation — this is why we ask that you, the professional, take the time to thoroughly review this guide for all pertinent details and requirements before installing our products.

If you are unsure about any of the information provided, need additional details, or want to confirm accuracy, please don't hesitate to contact a member of our educated staff — we're happy to assist in ensuring that both you and your clients are happy with the products and finished effects. We would prefer to communicate with you as often as needed versus having a product out there that you or your client are unhappy with.

If what you're looking for is outside of the guidelines you see in this manual, please contact us directly. We welcome the challenge of your custom creation. With our years of experience and fabrication capabilities — the possibilities are practically as limitless as your imagination.

WARRANTY: It is Oreq policy to replace or credit our customer for defective parts returned due to workmanship or material failure during the first year of sale. Prior factory approval is required for returns, along with original receipt. Failure to follow manufacturer's instructions for installation and/or care, voids all warranty. Oreq Corporation is not responsible for cost of removal of product or installation of replacement unit. Oreq is not responsible for shipping to or from facility or damage done by shipper.

WARNING: Improper chemical balance of pool water may cause corrosive conditions for metal water features. Oreq will not warranty products exposed to such water conditions or salt chlorine generators.

EXPERIENCE THE ELEMENTS

With over 25 years of manufacturing the highest quality water features to the pool industry, Custom Cascade™ is proud to introduce Fire Designs™; a full line of bowls, pits, and linear pans that integrate fire and water like never before. Give customers the drama of fire and elegance of water to create the ultimate sensory experience.

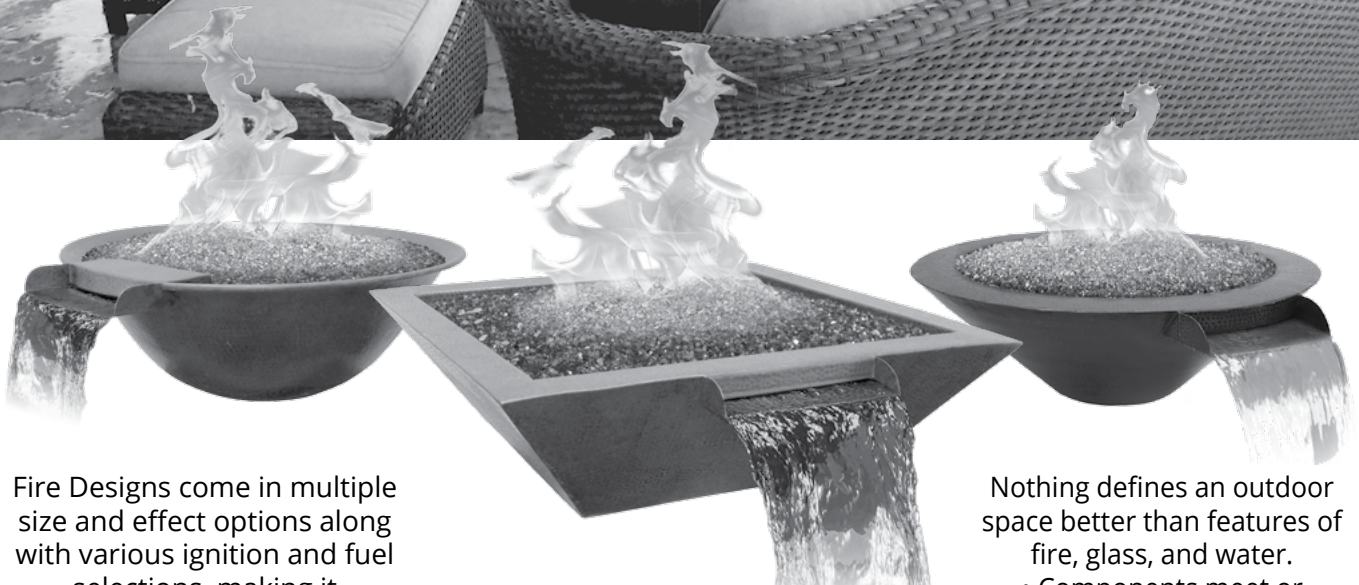

Fire Designs come in multiple size and effect options along with various ignition and fuel selections, making it an extremely versatile product line – perfect for any backyard environment.

Nothing defines an outdoor space better than features of fire, glass, and water.

- Components meet or exceed industry standards
- LLC and NFI certified
- Fire glass of the highest clarity and reflectivity.

Custom Cascade
fire designs™

A Division of Oreq Corporation

42306 Remington Ave. Temecula, CA 92590 • Phone 800-420-3255 • Fax 800-434-7660 • www.oreqcorp.com

