



Straight Shroud

PROJECT
CATALOG #
TYPE
NOTES

DE Down Light DESIGNER PLUS

Practical directional down light in 1, 3, 6, or 9 LED. Aluminum construction. An RGBW version is also available for use with **ZDC** systems.

Quick Facts

- Die-cast aluminum
- Two-layer marine-grade anodization and powder coat finish
- Cree® integrated LEDs
- ProAim™ adjustability
- Tamper-resistant features
- Color temperature filters
- Compatible with Luxor® technology
- Phase and PWM dimmable
- Input voltage: 10-15V

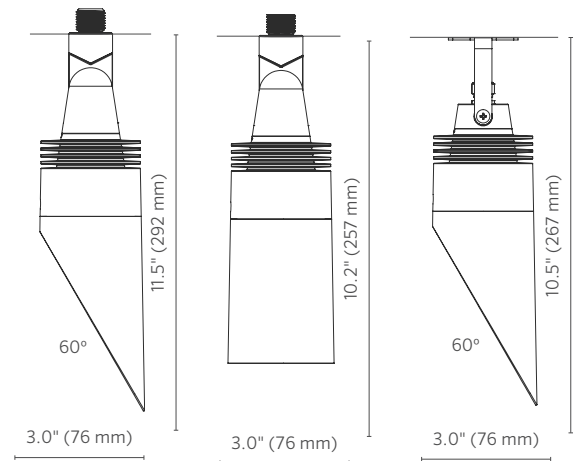

DE Down Light SPECIFICATIONS

Output	1LED	3LED	6LED	9LED	ZDC
Total Lumens[†]	59	162	328	344	93
Input Voltage	10 to 15V	10 to 15V	10 to 15V	10 to 15V	11 to 15V
Input Power (W)	2.0	4.2	8.2	10.0	9.1
VA	2.4	4.5	9.7	10.7	11.0
Efficacy (Lumens/Watt)	29	41	40	34	22
Color Rendering Index (CRI)	80+	80+	80+	80+	80+
Center Beam Candlepower*					
Spot (17-20)	322	958	2,064	1,912	192
Dimming	PWM, Phase**	PWM, Phase**	PWM, Phase**	PWM, Phase**	--
RGBW Available	No	No	No	No	Yes
Luxor Compatibility					
Default	Zoning	Zoning	Zoning	Zoning	--
ZD Option	Zoning/Dimming	Zoning/Dimming	Zoning/Dimming	Zoning/Dimming	--
ZDC Option	--	--	--	--	Zoning/Dimming / Color
Minimum Rated Life (L90)	55,000 Hrs	55,000 Hrs	55,000 Hrs	55,000 Hrs	55,000Hrs

* Information not available for Flood or Wide Flood.

** For optimal performance, use a trailing-edge, phase-cut dimmer.

† Measured using the 3,900K CCT lens. Multipliers for other CCTs include 0.80 (2,700K), 0.65 (4,500K), and 0.65 (5,200K).

DE Down Light SPECIFICATIONS

FX Luminaire

FX Luminaire is an industry-leading manufacturer of landscape and architectural lighting products with a focus on the advancement of LED technology and digital lighting control with zoning, dimming, and color adjustment capabilities. We offer a full spectrum of highly efficient lighting fixtures that can be utilized to create elegant, cutting-edge landscape lighting systems for commercial or residential applications. Our products are available exclusively via our extensive professional distributor network.

Materials

Die-cast aluminum A380 housing and shroud with stainless steel hardware. Die-cast zinc/aluminum alloy knuckle.

Socket

Socket contains MoistureBlock™ technology, preventing moisture from wicking up into sealed areas of the fixture.

Wiring

18 AWG (1 mm); SPT-1W; 220°F (105°C); 300V; 26' (8 m) length

Power

Input 10-15 VAC/VDC, 50/60Hz. Remote transformer required (specify separately)

Lamp

Integrated module with Cree LEDs. Gold-plated connectors and conformal coated for maximum reliability and corrosion resistance. Proprietary on-board intelligent driver uses firmware-controlled temperature regulation, maximizing LED life. Field upgradeable and replaceable, the LEDs are rated to 55,000 hrs. Maximum drive current: 1 A.

Weight

2.0 lbs. (0.9 kg)

Optics

Polycarbonate color temperature adjustment lenses included with fixture: 2,700K (preinstalled), 3,900K (no lens), 4,500K, and 5,200K. Interchangeable optics for 10°, 20°, 30°-32°, or 55-58° distributions ordered pre-assembled to fixture. Color temperature and beam angle lenses field serviceable. For additional color filters, spread lenses, hex baffles, etc., use MR-16 sized accessories (MR-16: 1.95" (50 mm) dia. x 1.1 mm thickness). Beam angle is calculated using LM-79 method for SSL luminaires.

Housing

Die-cast aluminum housing with capacity for 1LED, 3LED, 6LED, 9LED, or ZDC integrated LEDs

Shroud

Die-cast aluminum shroud with 60° cutoff. Straight shroud selection is 4" (100 mm) in length.

Hardware

Stainless steel angle lock screw with setscrew.

Knuckle

Die-cast zinc/aluminum alloy knuckle with ½"-14 (13 mm) NPSM threads. Compress and lock features prevent slip after installation. 9° increments adjustability over 220° of vertical adjustment. Optional wall mount knuckle includes curved anchor bolt pattern for 60° rotational adjustment and patented threaded studs with hex heads for ease of installation.

Lens

Tempered glass lens with shock resistance and high tolerance for thermal expansion and stress.

Finish

Two-layer protection of sulfuric acid anodization and polyester TGIC powder coat, providing superior outdoor weathering in all conditions. Tested to ASTM standards.

Ambient Operating Temperature

0°F to 140°F (-18°C to 60°C)

Installation Requirements

Designed for installation in the downward direction only.

Control

ZD or ZDC utilizes Luxor technology to zone light fixtures in up to 250 groups, dim each group in 1% increments between 0 and 100%, or change to one of 30,000 colors with RGBW LEDs. Select the ZD option for zoning/dimming or ZDC for zoning/dimming/color. Standard fixture is zoneable with Luxor.

Compliance

Compliant per IEC 60598-1 and IEC 60598-2-7 when used with the TreeBox® ("TB-XX") or alternate mount greater than or equal to IP65, or by selecting the "e" version.

Sustainability

Innovation meets conservation in the design and manufacturing of our products. Where we can, we use recycled materials while maintaining superior functionality. Our LED products provide high quality light at optimal energy efficiency, lifespan, and durability.

Warranty

10-year limited warranty









Manufacturing

ISO 9001:2015 certified facility

Listings



DE Down Light ORDERING INFORMATION







Fixture	Luxor Option	Output	Compliance	Mount	Shroud	Finish	
DE	■ [default] Zone	■ 1LED 59 Lumens	■ [default] North America (UL-listed)	■ [default] ½" (13 mm) NPSM Thread	■ [default] Angled Shroud 45°	■ BZ Bronze Metallic	
	■ ZD Zone/Dim	■ 3LED 162 Lumens	■ e International (CE approved)	■ [default with "e"] Bracket Mount	■ SS Straight Shroud 4" (102 mm)	■ DG Desert Granite	
		■ 6LED 328 Lumens		■ WM Wall Mount		■ WI Weathered Iron	
		■ 9LED 334 Lumens				■ SB Sedona Brown	
	■ ZDC Zone/Dim/Color	■ [default] 93 Lumens				■ FB Black	
						■ WG White Gloss	
						■ FW Flat White	
						■ AL Almond	
						■ SV Silver	

EXAMPLE FIXTURE CONFIGURATION: DE-ZD-3LED-SS-FW

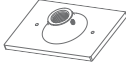

DE - - - - - -

DE Down Light ORDERING INFORMATION



MOUNTING OPTIONS: Specify Separately

Mounts	Code	
■ VERSABOX 2.2" (57 mm) x 1.5" (39 mm)	VB-050-XX*	
■ MINI J-BOX 3.5" (89 mm) x 1.3" (34 mm)	MJ-050-XX*	
■ TREE BOX 5.4" (138 mm) x 1.9" (49 mm)	TB-XX*	
■ GUTTER MOUNT 4.0" (102 mm) x 4.0" (102 mm)	GM-SS	
■ WALL PLATES 3.4" (85 mm) x 5.1" (129 mm)	WP-1G-050-XX*	
■ WALL PLATES 5.0" (127 mm) Diameter	WP-RD-050-XX*	
■ WALL MOUNT 3.5" (89 mm) x 2.0" (51 mm)	WM-XX*	



RISER OPTIONS: Specify Separately

Riser	Code	
■ RISER 0.8" (21 mm) Diameter	YY-R-XX*	
■ SIGN LIGHT RISER 0.8" (21 mm) Diameter w/ 45° Inward Curve	YY-R-SL-XX*	

COUPLING OPTIONS: Specify Separately

Couplings	Code	
■ STRAIGHT 1.3" (32 mm) x 2.0" (51 mm)	COUP-XX*	
■ 90° ELBOW 1.3" (32 mm) x 2.0" (51 mm)	ELBW-050-XX*	
■ T-MOUNT 3.0" (76 mm) x 2.2" (57 mm)	TMNT-050-XX*	

LENS ACCESSORIES: Specify Separately

Item	Code	
■ HEX BAFFLE MR-16 Size	250015260000	
■ LINEAR SPREAD LENS MR-16 Size	250013550000	
■ SOLITE SPREAD LENS MR-16 Size	250015240000	

*YY = riser height in inches (6" increments between 6" and 36"; 152 mm increments between 152mm and 914 mm), XX = finish code

DE Down Light PHOTOMETRICS

DE 1LED Illuminance at a Distance

Feet (Meters)	Center Beam	Beam Width	
		Vertical 18.5°	Horizontal 18.4°
4' (1.2 m)	20 fc (216 lx)	1' (0.4 m)	1' (0.4 m)
8' (2.4 m)	5 fc (54 lx)	3' (0.8 m)	3' (0.8 m)
12' (3.7 m)	2.2 fc (24 lx)	4' (1.2 m)	4' (1.2 m)
16' (4.9 m)	1.3 fc (14 lx)	5' (1.6 m)	5' (1.6 m)
20' (6.1 m)	0.8 fc (9 lx)	7' (2.0 m)	7' (2.0 m)



DE 3LED Illuminance at a Distance

Feet (Meters)	Center Beam	Beam Width	
		Vertical 18.3°	Horizontal 18.6°
4' (1.2 m)	60 fc (645 lx)	1' (0.4 m)	1' (0.4 m)
8' (2.4 m)	15 fc (162 lx)	3' (0.8 m)	3' (0.8 m)
12' (3.7 m)	7 fc (72 lx)	4' (1.2 m)	4' (1.2 m)
16' (4.9 m)	4 fc (40 lx)	5' (1.6 m)	5' (1.6 m)
20' (6.1 m)	2.4 fc (26 lx)	7' (2.0 m)	7' (2.0 m)

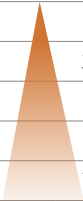

DE 6LED Illuminance at a Distance

Feet (Meters)	Center Beam	Beam Width	
		Vertical 18.3°	Horizontal 17.5°
4' (1.2 m)	129 fc (1,389 lx)	1' (0.4 m)	1' (0.4 m)
8' (2.4 m)	32 fc (347 lx)	3' (0.8 m)	3' (0.8 m)
12' (3.7 m)	14 fc (154 lx)	4' (1.2 m)	4' (1.2 m)
16' (4.9 m)	8 fc (87 lx)	5' (1.6 m)	5' (1.6 m)
20' (6.1 m)	5 fc (56 lx)	7' (2.0 m)	6' (1.9 m)

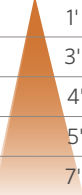

DE 9LED Illuminance at a Distance

Feet (Meters)	Center Beam	Beam Width	
		Vertical 19.1°	Horizontal 18.2°
4' (1.2 m)	119 fc (1,281 lx)	1' (0.4 m)	1' (0.4 m)
8' (2.4 m)	30 fc (322 lx)	3' (0.8 m)	3' (0.8 m)
12' (3.7 m)	13 fc (143 lx)	4' (1.2 m)	4' (1.2 m)
16' (4.9 m)	8 fc (81 lx)	5' (1.6 m)	5' (1.6 m)
20' (6.1 m)	5 fc (52 lx)	7' (2.0 m)	6' (1.9 m)

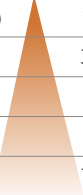

DE zDC Illuminance at a Distance

Feet (Meters)	Center Beam	Beam Width	
		Vertical 31.7°	Horizontal 37.6°
4' (1.2 m)	11.4 fc (123 lx)	2.7' (0.8 m)	2.3' (0.7 m)
8' (2.4 m)	2.8 fc (30 lx)	5.5' (1.7 m)	4.5' (1.4 m)
12' (3.7 m)	1.3 fc (14 lx)	8.2' (2.5 m)	6.8' (2.1 m)
16' (4.9 m)	0.7 fc (8 lx)	10.9' (3.3 m)	9.1' (2.8 m)
20' (6.1 m)	0.5 fc (5 lx)	13.6' (4.2 m)	11.4' (3.5 m)

