

COMMERCIAL FILTER

Owner's Manual

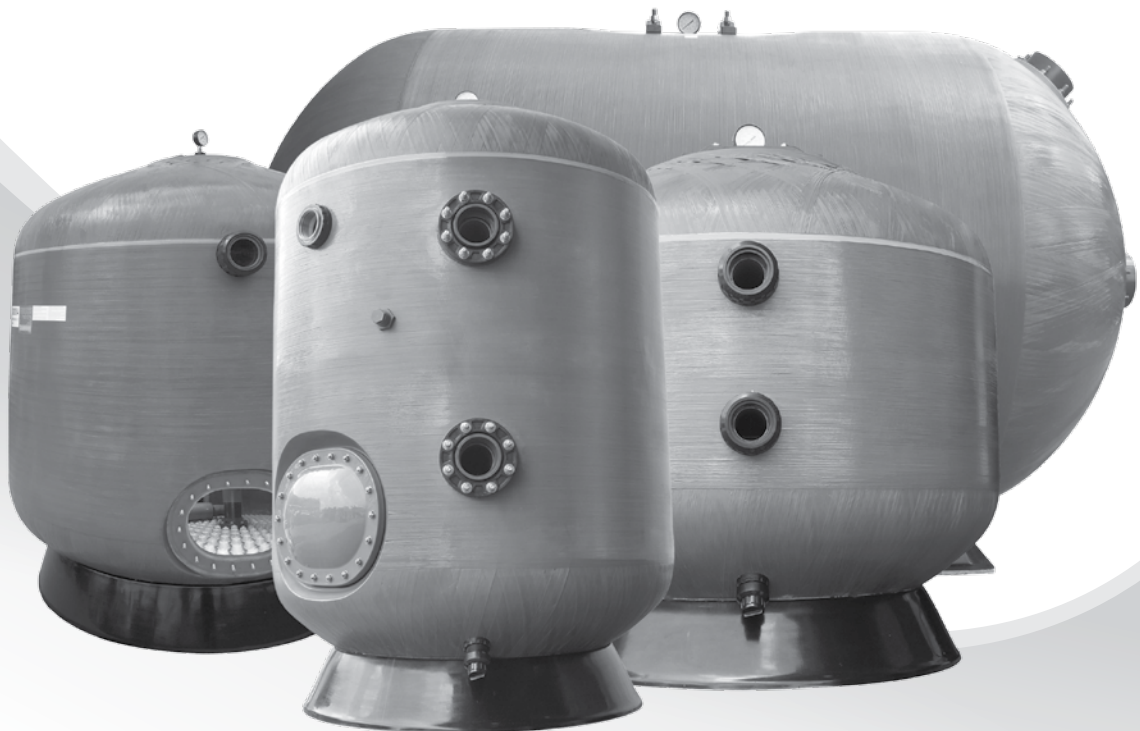

WARNING

This equipment must be installed and serviced by a qualified technician. Improper installation can create hazards which could result in property damage, serious injury or death. Improper installation will void the warranty.



Notice to Installer

This manual contains important information about the installation, operation and safe use of this product. Once the product has been installed **this manual must be given to the owner/operator of this equipment.**

Table of Contents

SAFETY INFORMATION	01
WATERCO FIBREGLASS FILTERS	02
MAXIMUM RATED PRESSURE	02
MATERIAL COMPATABILITY	02
FILTRATION	03
BACKWASH (Reverse flow)	04
AIR SCOUR BACKWASH	05
INSTALLATION	06
LIFTING	06
GENERAL LOCATION	07
CONNECTION AND PIPEWORK	07
DUAL PRESSURE GAUGE INSTALLATION	07
VALVE SET UP	08
DRAIN CONNECTION	09
DRAIN WATER ONLY - NO CONNECTIONS	09
CONNECT PERMANENT DRAIN VALVE/PIPE	09
INSTALLATION MEDIA	10
SIDE MOUNT MODELS	10
WET TESTING	10
ADDING MEDIA	10
LID INSTALLATION	11
DUAL YOKE LID TYPE	11
LOCK RING TYPE	12
INSTALLATION OF MULTIPOINT VALVE	13
MULTIPOINT VALVE OPERATION	13
BUTTERFLY VALVE MANIFOLD OPERATION	14
FILTER POSITION	14
BACKWASH POSITION	14
RINSE POSITION	14
INITIAL STARTUP	15
BACKWASHING	16
CONDITIONS FOR BACKWASHING	16
IMPORTANCE OF BACKWASHING	16
BACKWASHING INSTRUCTIONS	17
WITHOUT AIR SCOUR	17
WITH AIR SCOUR (No Multiport valve)	17
MAINTENANCE GUIDE	18
MEDIA REMOVAL	18
LATERAL MANHOLE AND BOLT TORQUES	19
LID ASSEMBLY	20
LATERAL / NOZZLE ASSEMBLIES	21
FLANGE ASSEMBLY	24
SIGHT GLASS ASSEMBLY PROCESS (80MM)	25
WINTERISING	25
WARRANTY	25

SAFETY INFORMATION

1. Waterco Commercial Fibreglass Vessels are designed to work with water at a temperature $> 0^{\circ}\text{C}$ / 32°F and $< 50^{\circ}\text{C}/122^{\circ}\text{F}$. The vessel should never be operated outside of these temperatures or damage may occur.
2. The installation should be carried out in accordance to local safety standards and by laws.
3. Any modification of the filter requires the prior consent from Waterco. Original replacement parts and accessories authorised by the manufacturer ensure a high level of safety. Waterco assumes no liability for the damage and injuries caused by unauthorised replacement parts and accessories.
4. The user should make sure that the installation is carried out by qualified authorised persons and that these persons have first carefully read the following instructions.
5. The operating safety of the filter is only guaranteed if the installation and operation instructions are correctly followed.
6. In the event of defective operation or fault, contact Waterco or its nearest authorised service agent.
7. To reduce the risk of injury, do not permit children or untrained personnel to use this product.
8. Incorrectly installed equipment may fail, causing severe injury or property damage.
9. Chemical spills and fumes can cause corrosion to metal components. Corrosion can cause equipment to fail, resulting in severe injury or property damage. Do not store chemicals near your equipment.

WATERCO FIBREGLASS FILTERS

Waterco Commercial Fibreglass Vessels embody the latest in fibreglass winding technology. Waterco Commercial Vessels consist of an inner shell of fiberglass reinforced polyester resin wound over with fibreglass filament.

Waterco's digitally controlled filament winding faultlessly winds continuous strands of high quality fibreglass filament under controlled tension to create a refined consistency and superior quality.

There are no special tank linings which can corrode or electrolyse.

MAXIMUM RATED PRESSURE

Waterco Commercial Vessels can be supplied with maximum rated pressures of;

2.5 bar / 36 psi maximum rated pressure

4 bar / 58 psi maximum rated pressure

6 bar / 88 psi maximum rated pressure

8 bar / 116 psi maximum rated pressure

And 10 bar / 145 psi maximum rated pressure in some models.

Whilst Waterco designs and manufactures Commercial Vessels to a superior quality, when designing a system allowances should be made for pressure surges such as;

- Pressure spikes at shut off
- Pressure build up from dirty media
- Other unforeseen pressure spikes

Maximum clean operating pressure should be at least 40% below maximum rated pressure.



It is the responsibility of the system designer/operator to ensure sufficient safety margin of operating pressure to the vessels' maximum rated pressure. Systems that are operated outside of the guidelines contained within this manual will void warranty.

MATERIAL COMPATABILITY

It is the responsibility of the system designer/operator to ensure that fluids, chemical compositions and concentrations, and the pH proposed to be used in the vessel are compatible with the materials of the vessel.

Contact Waterco prior to ordering to check compatibility.

FILTRATION

Waterco Commercial Vessels can be configured to provide general filtration, multi-stage water treatment filtration, chemical and odor removal, or demineralisation.

Designed for down-flow use, unfiltered water enters the vessel through the upper influent port. Once entering the distribution header, the water flows through a hydraulically balanced system of diverters strategically placed over the filter bed.

Even distribution of the water is achieved throughout the filter tank, which results in low levels of turbulence and minimal differential pressure losses. Water flow paths are parallel and vertical at the surface of the filter media bed resulting in flow capabilities up to $49\text{m}^3/\text{m}^2/\text{hr}$ or $20\text{ US gpm}/\text{ft}^2$ velocity without creating channeling within the media bed (depending on media type).

Water is passed through media in a downward direction where it is collected through the use of "V" slotted laterals or nozzles designed to retain the small filter media particles. After entering the collection header, the filtered water exits the tank through the lower effluent port.

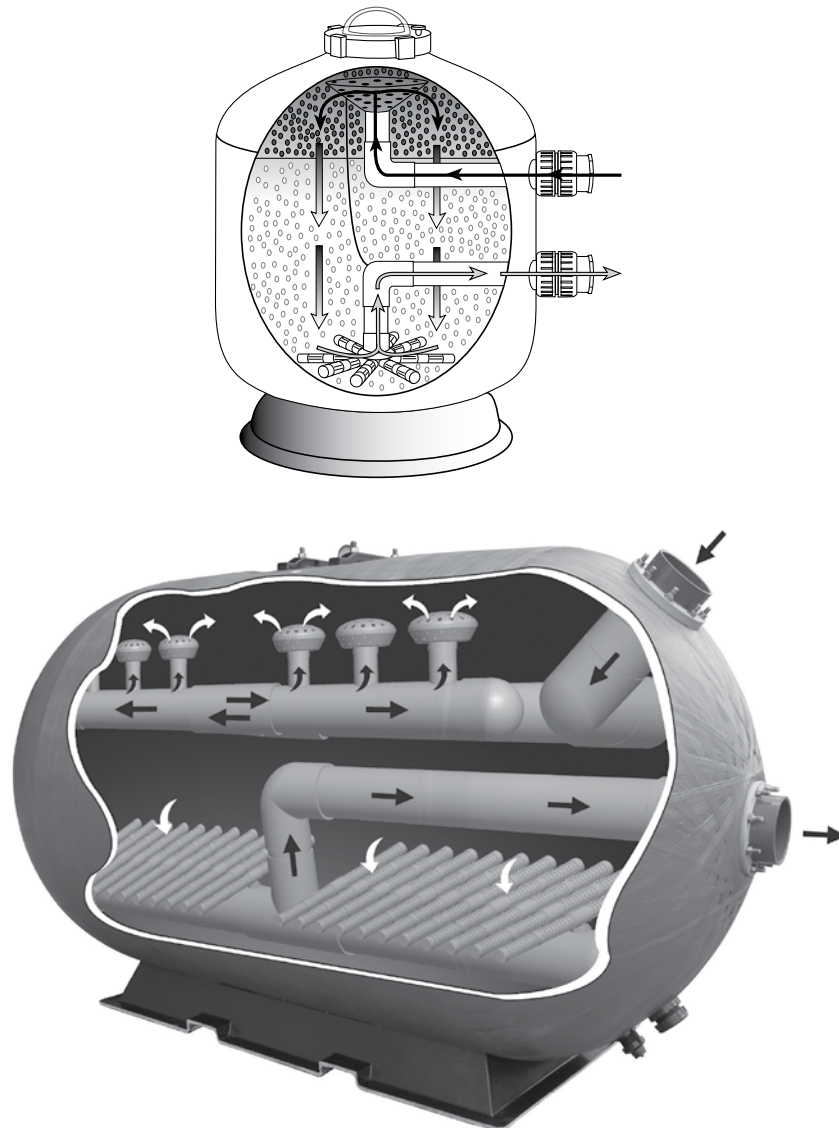

BACKWASH (Reverse flow)

Backwashing is the reversal of water flow through the media bed to cleanse the media.

As a guide, the backwash cycle would occur when pressure differential reaches 50kPa / 7-10 psi above the clean filter pressure i.e. after installation or after backwash procedure and clean media.

Waterco recommend the use of the Waterco Dual Pressure Gauge for all installations to assist in determining backwash requirements (This model for use for up to 4 bar applications only).



Backwashing is achieved by reversing the water flow into the collection laterals or nozzle plate, up through the filter bed. Wastewater is then collected through the distribution header and exits through the top port.

This reversal of flow will cause the filter bed to lift and expand, (also called fluidisation). The fluidisation of the media bed allows the collected solids to be released and discharged to waste.

The hydraulic balance created through the distribution and collection system design reduces water velocity to below that of the media-settling rate, preventing loss of filter media during backwash.

Design backwash velocity for Waterco Commercial Vessels is 36m³/m²/hr, with a maximum of 49m³/m²/hr or 15-20 US gpm/ft² of filter area.

System designers should consider velocity requirements of the media being used.

AIR SCOUR BACKWASH

Waterco SPDD and MPD series nozzle plate vessels may use air assisted backwash.

SM/SMD/SMDD and M/MD series, custom air scour laterals and 2"ARV must be included to allow air assisted backwash.

Please consult Waterco prior to ordering vessels so that suitable vessels can be quoted and constructed.

There are two options of air scour backwashing available;

1. Air only followed by water flush
2. Air + water

Waterco does not recommended using air OR air and water at the same time without suitable design by a qualified hydraulic engineer.

Air velocity is generally $50\text{m}^3/\text{m}^2/\text{hr}$ or $3\text{-}5\text{ CFM}/\text{ft}^2$ depending on method, and provides a more efficient backwash method saving up to 25% water per backwash.

The time taken to backwash various types of media will vary, depending on;

1. If the backwash is air scour assisted
2. The debris, density or content of collected material
3. The media type
4. The backwash velocity
5. If flocculants are used

As a general guide, backwashing using a velocity of $36\text{-}48\text{m}^3/\text{m}^2/\text{hr}$ or $15\text{-}20\text{ US gpm}/\text{ft}^2$ may take between 3-5 minutes depending on media loading. Additionally backwashing while injecting air requires a reduction in backwash flow rate of 30-50% to prevent losing the media.

NOTE: Up-flow filtration should only be performed if the vessel has been specifically designed for this use. Please consult Waterco prior to ordering vessels for up flow use.

INSTALLATION

LIFTING

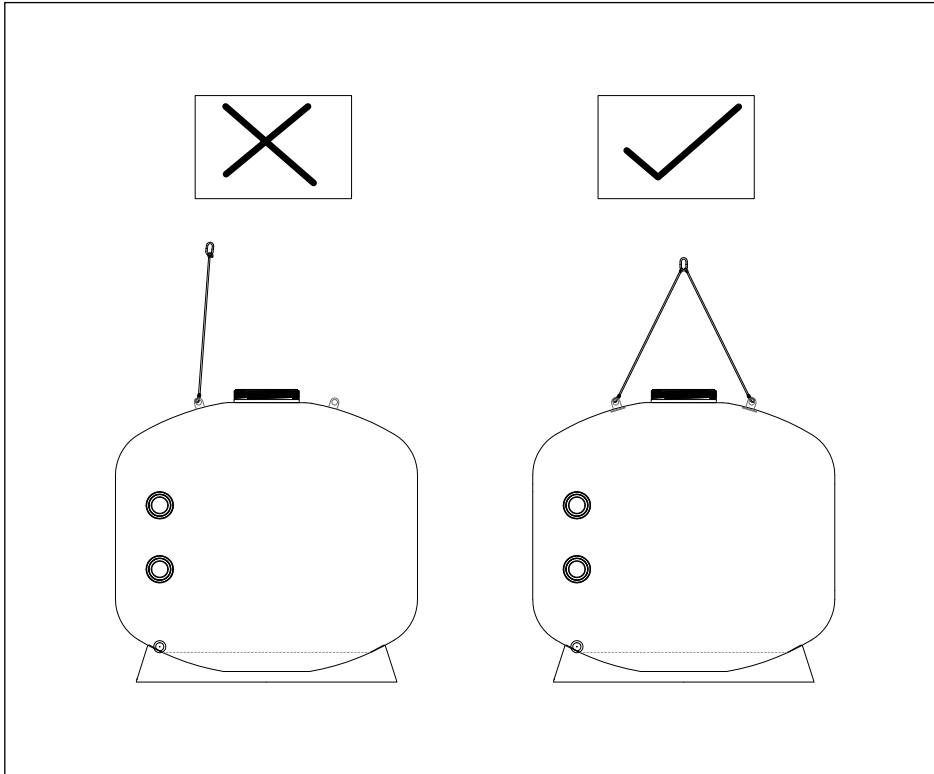

GENERAL LOCATION

1. Vessels should be located so that they are free from flooding, such as away from sumps, flood areas etc.
2. Vessels should be placed on a suitable base (such as level concrete) that is designed to accommodate the operational weight of the vessel i.e. filter dry weight + media + water.
3. Vessels should, where possible be positioned under cover from direct sunlight.
4. Vessels should be positioned so that they are easily accessible for the operation of the valve system.
5. Vessels should be positioned so that manholes and sight glasses can be easily accessed (please consult Waterco for custom designs and location of manways and sight glasses etc).
6. Vessels should ideally be positioned as close as possible to the water source and plant.

CONNECTION AND PIPEWORK

7. Where Waterco Commercial Vessels are provided with a flange connection, bellows type flexible joints should be used between plant pipework and the vessel flange to facilitate any movement.
8. Always use sufficient pipe supports to eliminate stress on bulkhead ports or flanges. The piping should be supported independent of the filter.
9. Check that the incoming water pressure is within the filter's recommended working pressure.
10. A pressure limiting device should be installed to prevent maximum operating pressure being exceeded.
11. Install isolation valves at the inlet and outlet of the vessel or on the inlet and outlets of the Multiport Valve. This will allow maintenance if the vessel is below water level or connected to mains water supply.
12. Minimise the length of pipe and the number of fittings to minimise restrictions to water flow.
13. Connect all plumbing to the Multiport Valve or valve battery set up, taking care that all plumbing connections are glued and tightened securely to prevent leaking.
14. Ensure solvents are not excessively applied to fittings as this could damage O'rings and create sealing problems.
15. Do not over tighten fittings or adapters.

DUAL PRESSURE GAUGE INSTALLATION

Refer to the Dual Pressure Gauge manual

VALVE SET UP

Waterco's Commercial Vessels with bulkhead ports are suitable for use with Waterco Multiport Valves. 50mm (2"), 65mm (2.5"), 80mm (3") or 100mm (4") options are available.

For vessels supplied with flange or bulkhead ports which do not have a Multiport valve, the following valve configurations may be used;

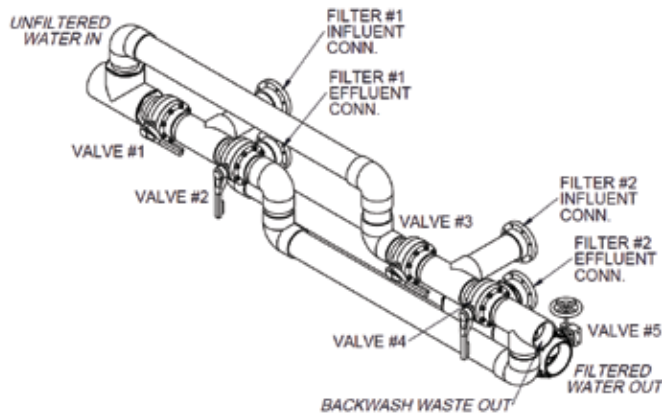
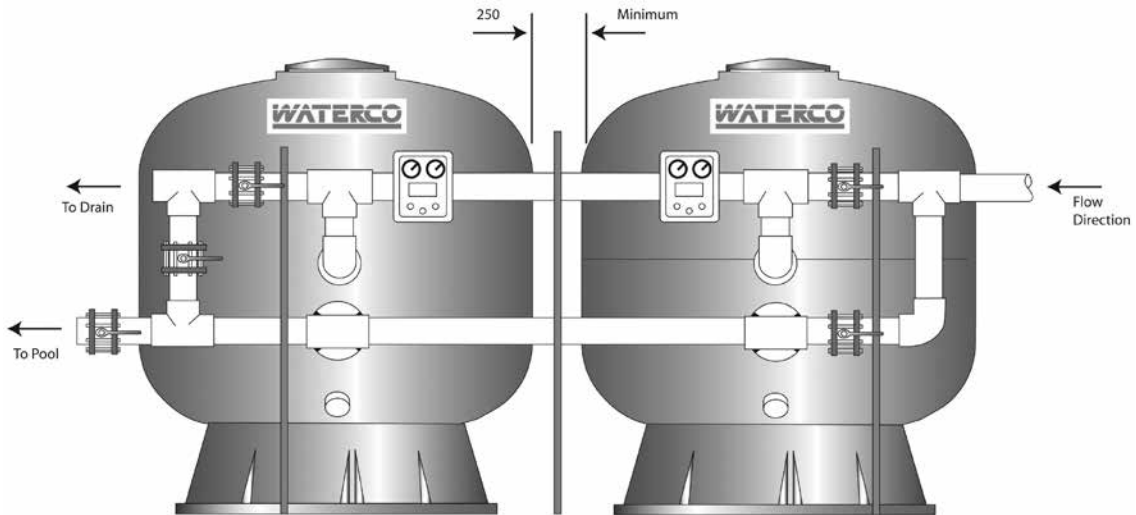
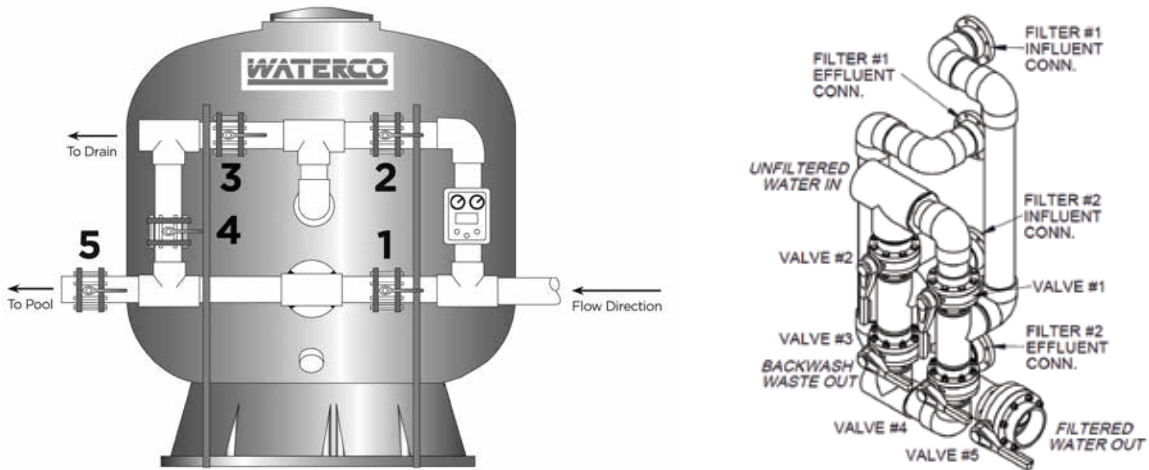

DRAIN CONNECTION

The drain connection can be used to drain water or water and media from the vessel

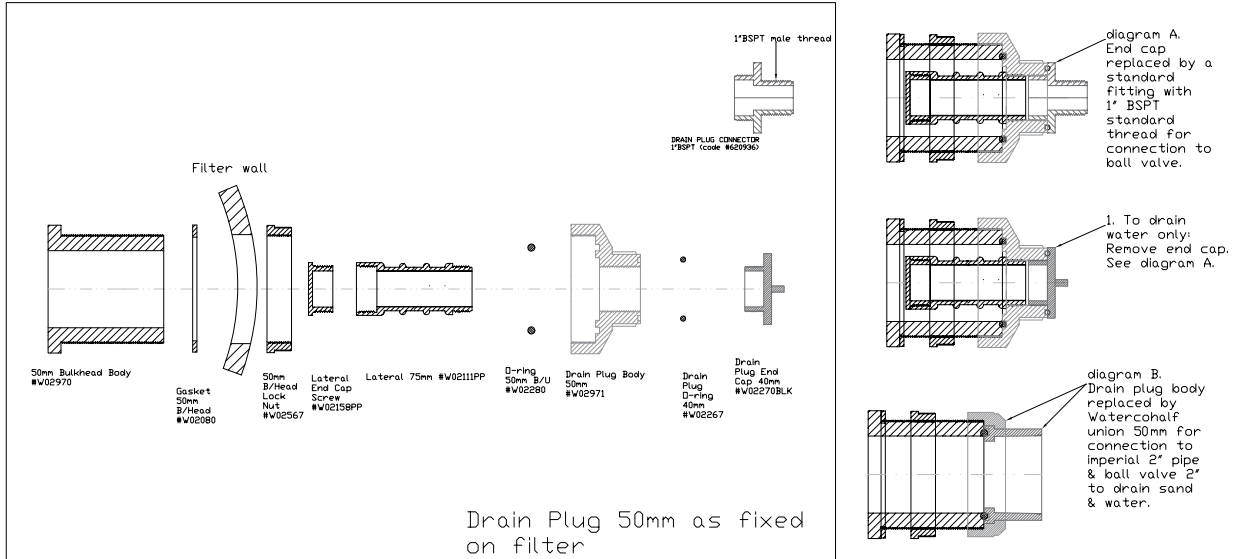

(40/50/80mm or 1.5/2.0/3.0" drain assemblies are the same)

DRAIN WATER ONLY - NO CONNECTIONS

- 16. To drain water only, remove Drain End Cap, taking care not to touch or release tension on the bulkhead lock nut

CONNECT PERMANENT DRAIN VALVE/PIPE

If utilising any connections to the drain assembly, take care not to touch or release tension on the bulkhead lock nut.

- 17. For ALL vessels;
 - a. Remove the Drain Plug Cap only, taking care not to touch or release tension on the bulkhead lock nut
 - b. Replace the Drain Plug Cap with the adaptor
 - c. Connect pipework to the adaptor
- 18. For SPDD or MPD series vessels ONLY;
 - a. release the drain plug body assembly taking care not to touch the bulkhead lock nut
 - b. remove the drain plug body and lateral and end cap media protection
 - c. replace drain plug body with Waterco half union Diagram B. (either 40mm or 50mm depending on model)
 - d. connect pipework to Waterco half union
 - e. secure external pipework to ensure no movement or leverage on bulkhead connection
- 19. MEDIA FLUSH OUT
 - a. Remove the Drain Plug Body including the Drain Plug End Cap, taking care not to touch or release tension on the bulkhead lock nut
 - b. Remove the section of filter lateral (media protection)
 - c. Media will flow out through the drain. Fluidise media within the filter for best results

INSTALLING MEDIA

SIDE MOUNT MODELS

Before installing media, install the Multiport Valve or flanged pipework (see “INSTALLATION OF MULTIPORT VALVE” below)

The volume of media added should not exceed the vessel design specification. This is to avoid bed expansion causing media loss.

(see the vessel specification sheet or consult Waterco)

WET TESTING

Before adding any media to the filter, the filter must be filled with water and the system run in both filter and backwash modes to test for any possible leaks of the filter or pipework.

Waterco vessels are pressure tested at the factory before shipping. It is possible though, that during transit the tank or fittings may have been damaged.



Waterco does not accept any claim for the costs of media removal and replacement required where the filter was not adequately wet tested on site before filling with media.

ADDING MEDIA

1. A coarse (2-5mm) gravel under bed may be used around the lateral collector assembly, or 100mm over nozzle plates.
2. Before filling the media, perform a visual check of the laterals. Look for broken or loose laterals. Replace if necessary.
3. Ensure all flanges are secured and pipework is glued.
4. Fill the vessel to one third (1/3) of capacity with water.
5. Commencing with media under bed, slowly load media to the side of the vessel. Avoid loading heavy amounts at high velocity onto the lateral collector system or nozzle plate.
6. Where multimedia beds are used, level each bed at the desired level before loading the next grade.

LID INSTALLATION

NOTE: Lubricant should be silicon based and not petrochemical based

DUAL YOKE LID TYPE

See assemblies section (page 20) for further detail

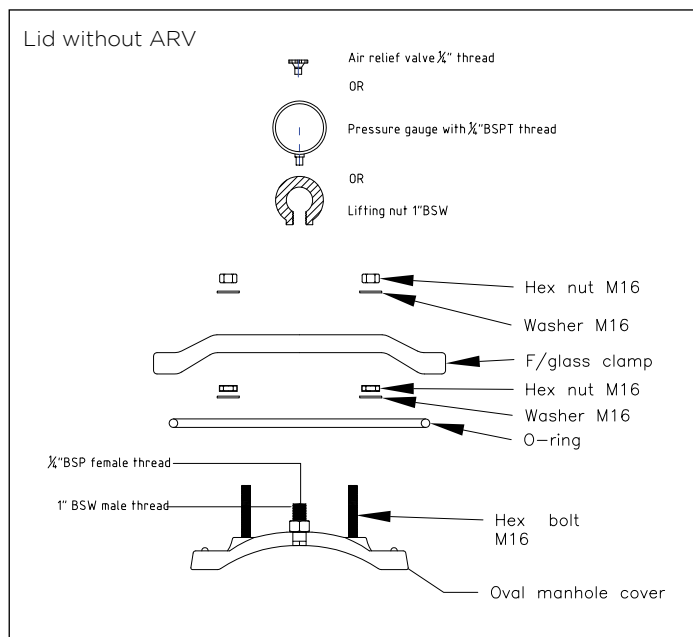
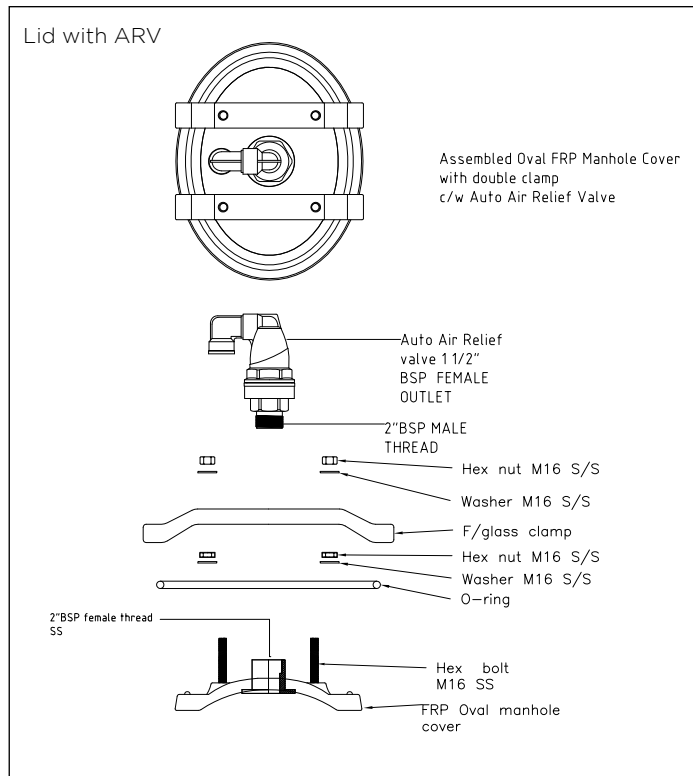

LOCK RING TYPE

1. Clean the inner sealing surface and O-ring thoroughly before inserting O-ring to the lid
2. Place the lid (with O-ring installed) in position, gently pushing into place
3. Place the lock ring over the lid and firmly hand tighten
4. Do not over tighten

See assemblies section (page 20) for further detail

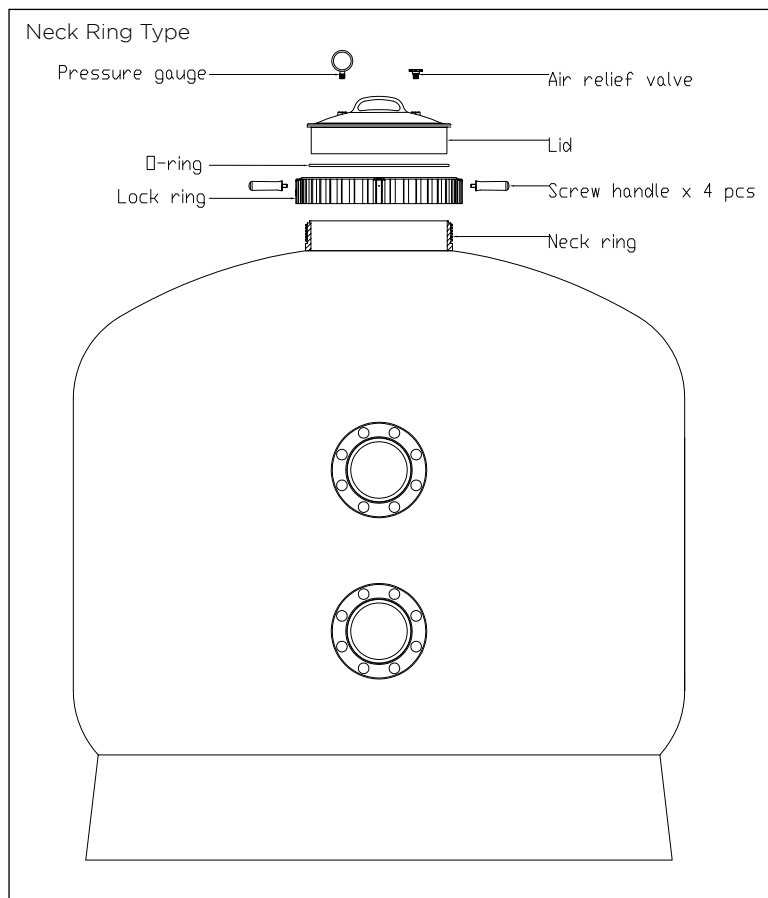

INSTALLATION OF MULTIPOINT VALVE

Side Mount Fibreglass Filters are supplied with the option of a Side Mount Multiport Valve with a plumbing kit designed to be connected to the side ports of the filter.

1. Align the Multiport Valve's plumbing kit with the filter's threaded connection ports. Screw the plumbing kit's barrel unions onto the filter connection ports and hand tighten. Do not over tighten the barrel unions as this can lead to damage and void warranty.
2. Screw the Multiport Valve barrel unions onto the threaded connection ports of Multiport Valve and hand tighten. The barrel union should be firmly threaded into the Multiport Valve and there should be no play between the thread. Do not over tighten the barrel unions as this can lead to damage and void warranty.
3. Glue the PVC pipe to the barrel unions and Allow 24 hours for glue (solvent) to set before starting the filter.
4. Test the filter and check for leaks around the threads.

MULTIPOINT VALVE OPERATION

1. Filter - Position for filtration
Incoming water from the piping system is automatically directed by the Multiport Valve to the top of the filter bed. As the water is pumped through the filter bed, dirt and debris are trapped by the filter bed. The filtered water is returned from the bottom of the filter vessel, through the Multiport Valve and back through the piping system
2. Backwash - Position for cleaning the filter media
Water flow is reversed by the Multiport Valve through the filter bed so that water flow is directed to the bottom of the filter vessel and up through the filter bed, flushing the previously trapped dirt and debris out the waste line
3. Rinse - Position for flushing the filter system
The water flow is directed by the Multiport Valve through the filter bed and out. This process settles the filter media bed into place and ensures any dirt or debris is rinsed out of the filter, preventing dirt or debris returning to the system

NOTE: This position is not available on 4-Way Multiport Valves
4. Waste - Position for bypassing the filter bed to waste
The water flow is directed by the Multiport Valve straight to the backwash outlet, bypassing the entire filter bed. This Multiport Valve position is used lower the water level or for vacuuming water with high dirt loads
5. Re-circulate - Position for bypassing the filter bed
The Multiport valve recirculates water flow directly back to the system, bypassing the filter
6. Closed - Position for closing all flow to the filter
The Multiport Valve can be closed to enable servicing of pump without draining the water from the filter. This position is not to be used with the pump operating

NOTE: Operation of the Multiport Valve or mode selection is to be always done with the pump switched off

BUTTERFLY VALVE MANIFOLD OPERATION

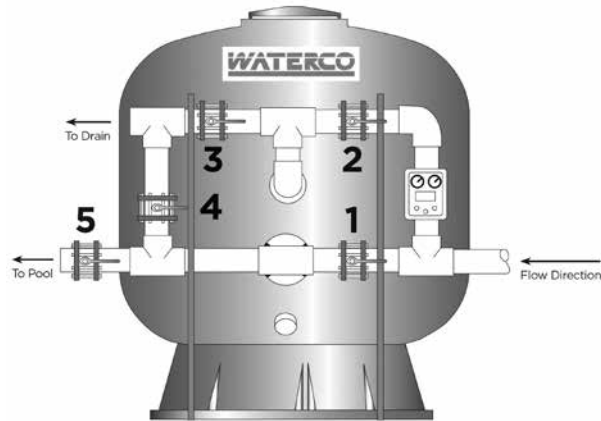

FILTER POSITION

1 CLOSED 2 OPEN 3 CLOSED 4 CLOSED 5 OPEN

BACKWASH POSITION

1 OPEN 2 CLOSED 3 OPEN 4 CLOSED 5 CLOSED

RINSE POSITION

1 CLOSED 2 OPEN 3 CLOSED 4 OPEN 5 CLOSED

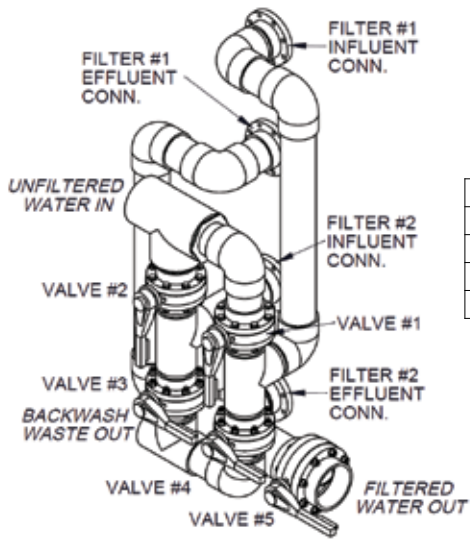

	FILTRATION (BOTH FILTERS)	BACKWASH (FILTER #1)	BACKWASH (FILTER #2)
VALVE #1	OPEN	CLOSED	OPEN
VALVE #2	OPEN	OPEN	CLOSED
VALVE #3	CLOSED	CLOSED	OPEN
VALVE #4	CLOSED	OPEN	CLOSED
VALVE #5	OPEN	ADJUSTED	ADJUSTED

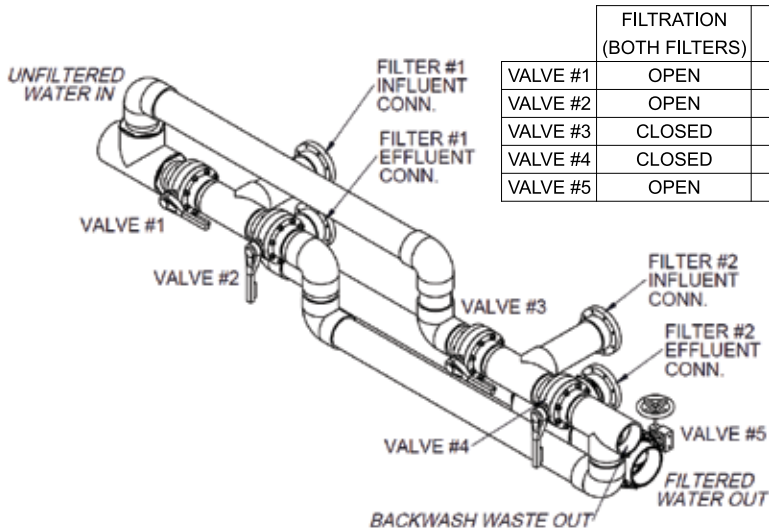

	FILTRATION (BOTH FILTERS)	BACKWASH (FILTER #1)	BACKWASH (FILTER #2)
VALVE #1	OPEN	CLOSED	OPEN
VALVE #2	OPEN	OPEN	CLOSED
VALVE #3	CLOSED	CLOSED	OPEN
VALVE #4	CLOSED	OPEN	CLOSED
VALVE #5	OPEN	ADJUSTED	ADJUSTED

INITIAL STARTUP

1. Be sure the correct amount of filter media is in the filter vessel and that all connections are sound
2. Using the RINSE setting in the first instance will ensure swarf and debris contained in the system pipework does not block the collectors if BACKWASH was to be used in the first instance
3. In the RINSE setting, open the air relief valve and open filter valves to allow the filter to fill with water.
4. Turn the pump on for 2-3 minutes
5. Purge air from the air relief valve
6. Turn the system off and re-set the valves or Multiport valve to perform a backwash
7. Whilst air is present in the filter, slowly fill the filter until air is purged from the vessel
8. Once a steady flow of water is running through the waste line, close the air relief valve and let pump run until water is clear through waste line (may take up to 3 minutes)
9. Perform a rinse cycle for 2-3 minutes
10. Repeat steps 7-9 until the backwash water is as clean as the influent water quality

The initial backwashing of the filter is recommended to remove any impurities or fine particles from the filter media

11. Set the vessel to filter and run the pump
12. Record the pressure gauge reading and note as 'clean pressure'
13. Check all flanges, ports, lid and manholes, sight glasses and drain for any leaks.

After a period of time, the accumulated dirt and debris in the filter causes a resistance to flow. The pressure will start to rise and the flow of water will start diminishing. When the pressure is between 50 to 70 kPa or 7 to 10 psi higher than the initial "Start-up" pressure, it is time to backwash (clean) the filter (see BACKWASHING).

If the differential pressure required to trigger a backwash is not achieved, a backwash should be performed at regular intervals to prevent media solidifying or channelling.

BACKWASHING

The function of backwashing is to separate the deposited particles from the filter media grains and flush them from the filter bed. Backwashing is achieved by reversing the flow of water through the filter bed at a fairly high flow rate. This high flow rate expands the filter bed and the water flow carries the debris out to waste.

CONDITIONS FOR BACKWASHING

Time for backwashing is determined by the following conditions:

1. The flow rate through the filter bed decreases until it is insufficient to meet the demand
2. The removal efficiency of the filter bed decreases to the point where filter water quality deteriorates or results in dirt or debris passing through the system
3. When the pressure is between 50 to 70 kPa or 7 to 10 psi higher than the start-up pressure
4. If the differential pressure required to trigger a backwash is not achieved, a backwash should be performed at regular intervals to prevent media solidifying or channelling.
5. If the filter is connected to mains water, pressure rise is not an accurate indicator as mains pressure tends to fluctuate. It is best to rely on the actual flow rate or a predetermined time.

IMPORTANCE OF BACKWASHING

The importance of backwashing cannot be overstated. Dense filter media can become “packed” without proper and frequent enough backwashing. Debris will remain trapped and create channelling within the filter bed. This will result in the filter bed exhausting early. If debris is not flushed from the media grains, the filter bed will become blocked as time goes on until the filter operation fails.

BACKWASHING INSTRUCTIONS

Note, this manual does not cover every possible instalment, valving option or customised design. Only trained and suitably qualified persons who understand the design should operate the equipment. If the system is not operated as it has been designed, excessive flow or pressure build up could damage equipment or cause personal injury.

WITHOUT AIR SCOUR

1. Shut OFF the pump prior to making any valve position changes
2. Move influent butterfly valve to the OFF position before moving any other valves
3. Move the Multiport valve or butterfly valve manifold to the BACKWASH position
4. When the backwash water in the waste line sight glass appears clear, switch OFF the pump
5. Move the Multiport valve or Valve Battery to the RINSE position
6. Switch ON the pump
7. When the backwash water in the waste line sight glass appears clear, switch OFF the pump
8. Move the Multiport valve or Valve Battery to the FILTER position
9. Switch ON the pump for normal operation

WITH AIR SCOUR (No Multiport valve)

1. Switch OFF the pump and close the isolation valves
2. Release the filter's pressure through the easy reach air relief until the Pressure Gauge needle drops to zero (0)
3. Ensure the 2" Air Relief Valve is operational
4. Move Valve Battery to the BACKWASH position
5. Open the air blower valve
6. Switch ON the air blower (for 2-3 minutes)
7. Switch OFF air blower and close the air blower valve
8. Switch ON the pump
9. When the backwash water in the waste line sight glass appears clear, switch OFF the pump
10. Move Valve Battery to the RINSE position
11. Switch ON the pump
12. When the backwash water in the waste line sight glass appears clear, switch OFF the pump
13. Move the Valve Battery to the FILTER position
14. Switch ON the pump for normal operation

MAINTENANCE GUIDE

The filter media will only require replacement once it has reached the limits of its designated life. Refer to the product information of the particular filter media used.

To ensure the maximum life of the selected filter media, please follow the procedures below:

1. Backwash the filter regularly according to the instructions set under "BACKWASHING".
2. Refer to the specifications of the filter media used and implement regeneration procedures accordingly
3. For closed loop systems such as swimming pools:
Maintain a correct chemical balance of your pool / spa water. The chemical balance of water is a relationship between its pH, total alkalinity, calcium hardness and water temperature. The water balance should be maintained at all times within -0.2-+0.2 on the Langelier Saturation Index.
4. For one pass systems such as water treatment plants:
Water feed supplies need to be monitored. Saturation (life) in mains water or bore (rural) will vary depending on water quality.
5. Replace the pressure gauge if faulty readings are observed
6. Maintain the 2" Air Relief Valve and/or replace if there is any doubt about its operation.

MEDIA REMOVAL

1. Ensure that the pump or water supply is OFF and that all isolation valves are in the CLOSED position
2. OPEN the air release valve to remove any positive or negative pressure within the vessel
3. Remove the top manhole or top mounted Multiport valve
4. Using a slurry pump, extract the media taking care not to damage distributor or collector systems. Take extra care when reaching the lower collector systems as these can easily be broken by slurry pumps.
5. Where lateral manhole is installed in the vessel, remove this when media reaches below the manhole level. This will assist easier access for media removal in the lower areas on the vessel
6. Underdrain laterals are easily unscrewed to allow access to media under the collector system
7. Re-install lateral manhole, ensuring O-ring is lubricated with silicone based lubricant
8. Once media is removed and vessel is cleaned out, perform any repairs required and re-install new media as per "INSTALLING MEDIA" above.

LATERAL MANHOLE AND BOLT TORQUES

The lateral manhole may be removed once media is removed to a level below the lateral manhole. Always ensure new Orings are on site prior to removal of top or lateral manholes.

To remove the lateral manhole;

1. Loosen nuts evenly in an oppositely opposed pattern, one half (1/2) turn at a time
2. Remove the cover - this may take a small amount of leverage to break the seal to O-ring
3. Remove the O-ring

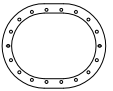
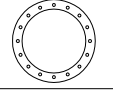
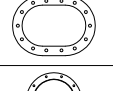
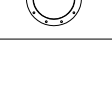
Side hatch/Lateral manhole cover	Bolt size	No. of bolts	Recommended tightening torque (N m)
	M12	18	50
	M12	16	50
	M12	14	50
	M8	10	15

LATERAL MANHOLE

LID ASSEMBLY

LID WITH YOKES

With 2" ARV;

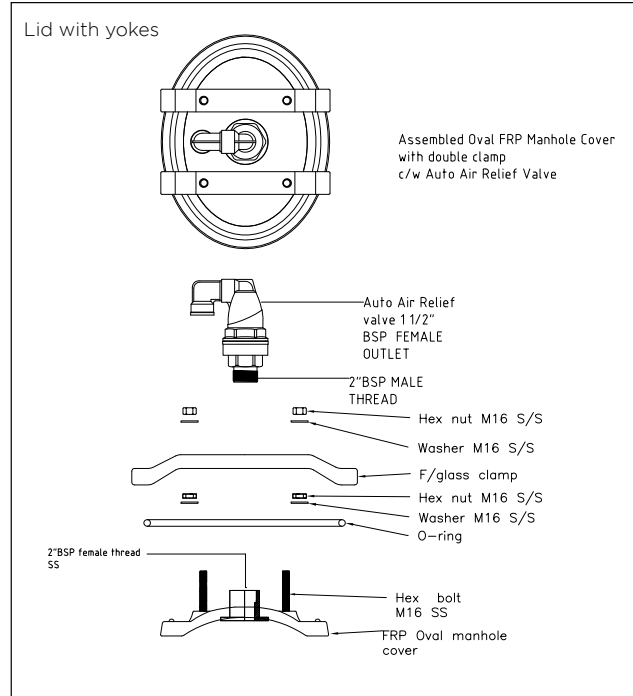
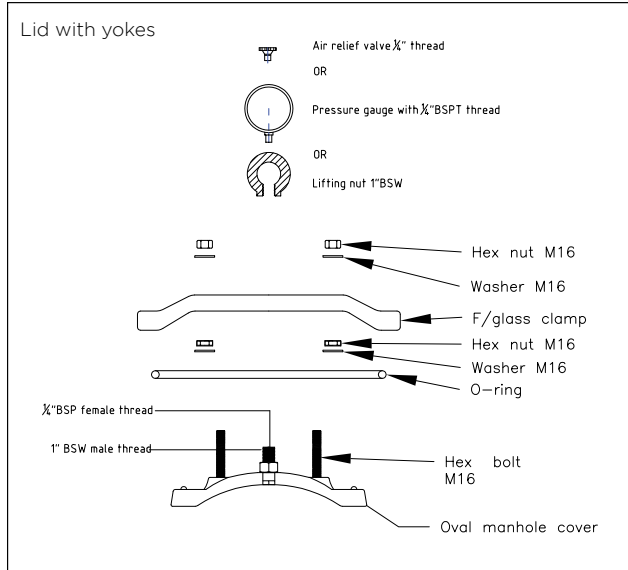

NECK RING STYLE

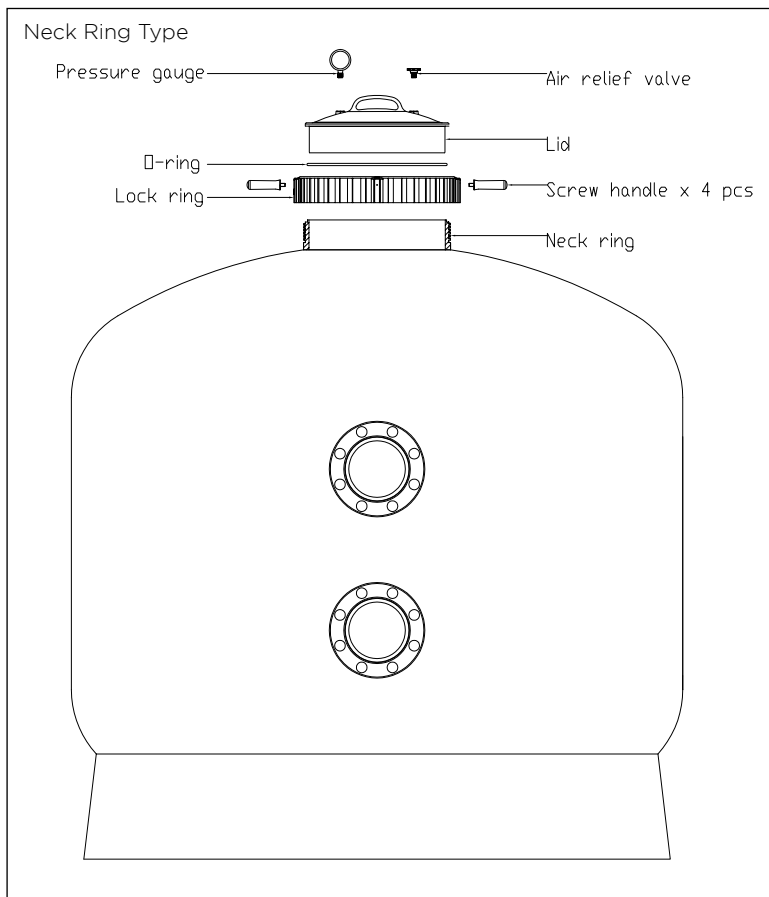

LATERAL / NOZZLE ASSEMBLIES

STANDARD LATERAL

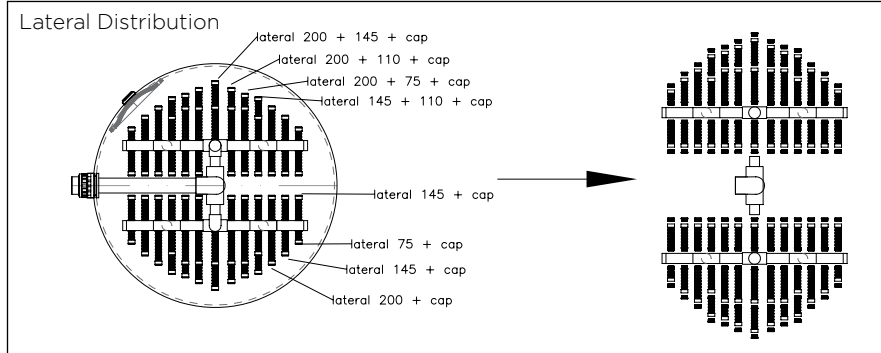

AIR SCOUR LATERAL

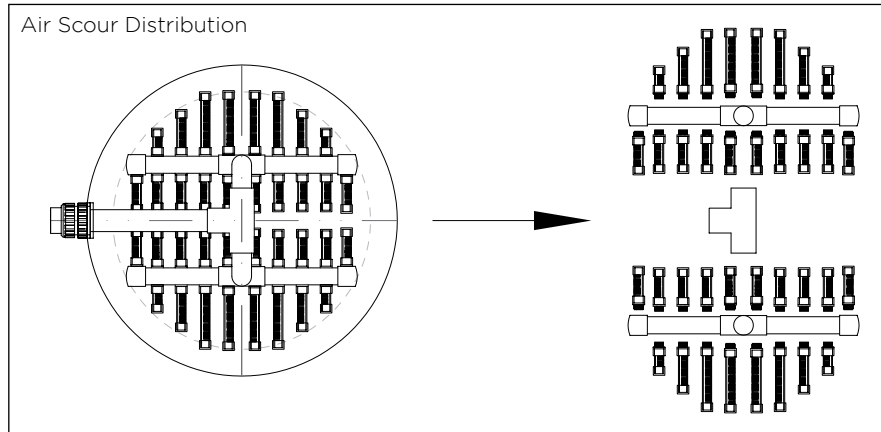

HORIZONTAL VESSEL

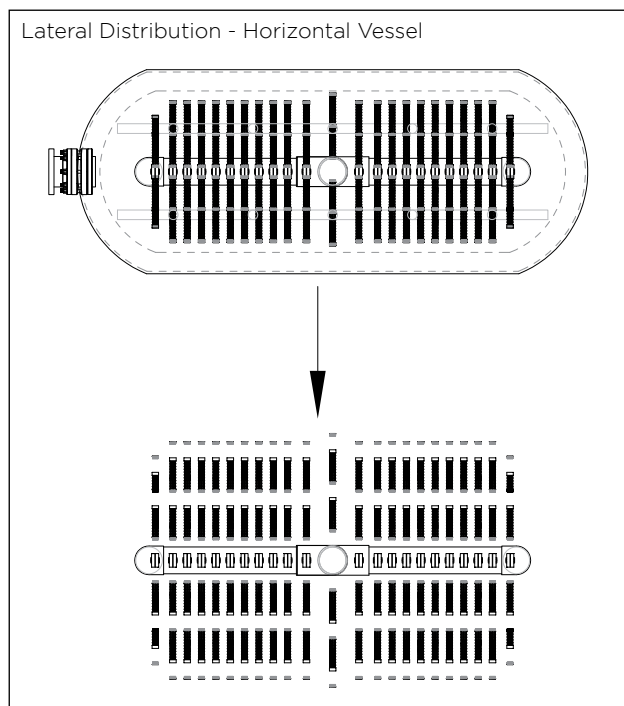

NOZZLE (PLATE)

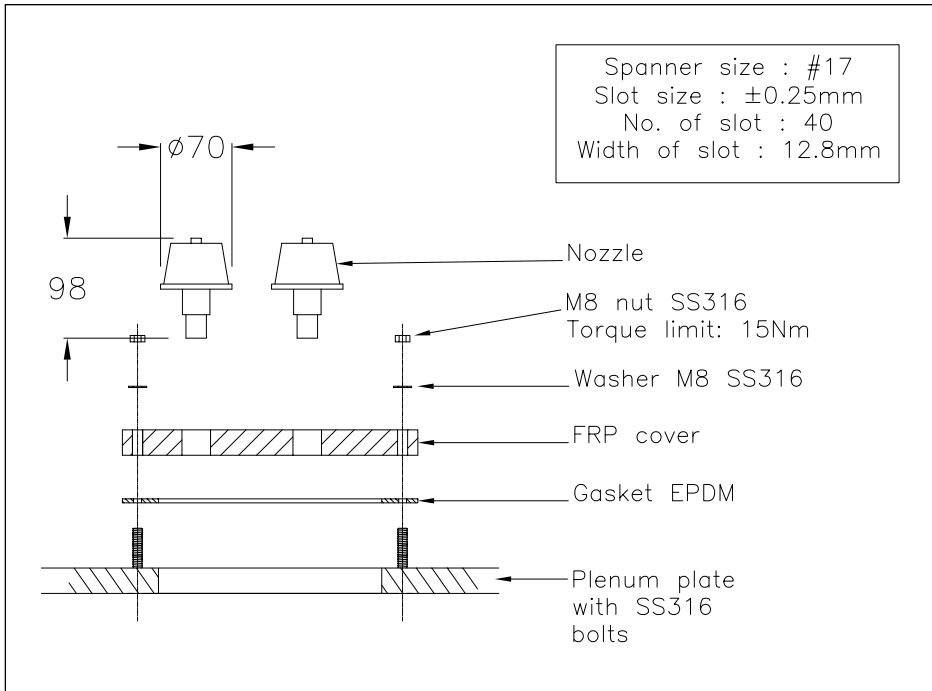

BULKHEAD ASSEMBLY

Refer to Sight Glass assembly/replacement instructions

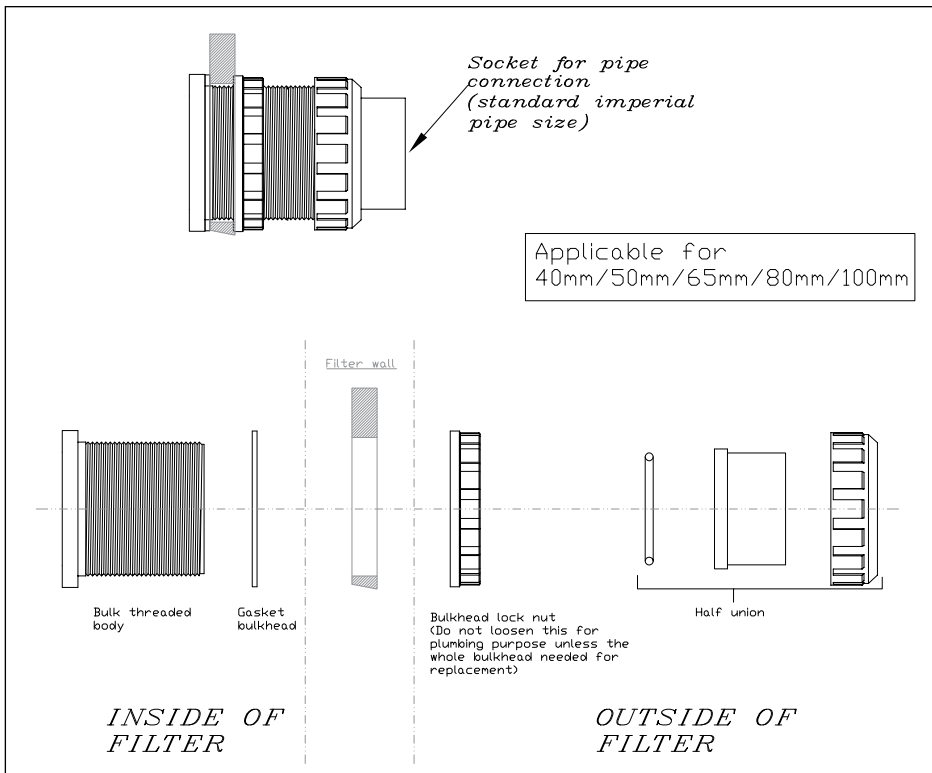

FLANGE ASSEMBLY

Refer to Sight Glass assembly/replacement instructions

Flange - Exploded view

Outside of filter | Filter wall | Inside of filter

Item	Description	Flange size	No. of hex nut	Thread diameter	Recommend tightening torque for hex nut/bolt with lubricant copperslip (N m)
1	Flange stud ring				
2	Gasket flange	3"	4	5/8" BSW	100
3	PVC flange	4"	8	5/8" BSW	100
4	Flange clamp ring	6"	8	3/4" BSW	165
5	Washer	8"	8	3/4" BSW	165
6	Hex nut	10"	12	7/8" BSW	240

SIGHT GLASS ASSEMBLY

Refer to Sight Glass assembly/replacement instructions

Outside of filter | Filter wall | Inside of filter

Applicable for 2"/3"/4"/6"

Locking nut | Gasket | Acrylic sight glass

FLANGE ASSEMBLY

1.

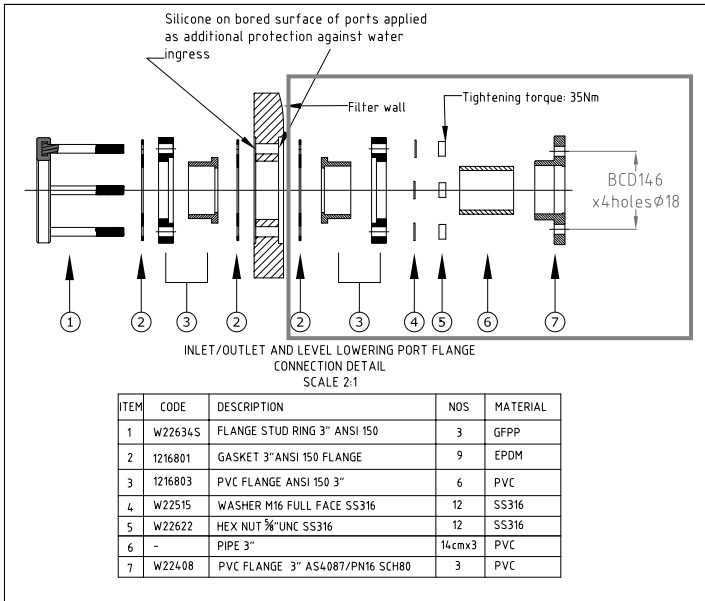

Will be provide by WFE (glued joint)



2.



Dismantle all 4 nut & take out the damage flange.

3.

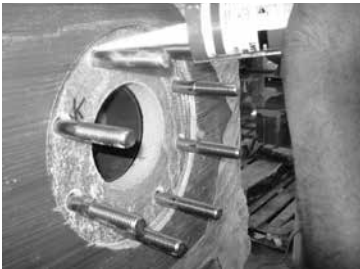

Clean filter wall. Should have silicon old silicon mark.
Wipe with acetone.
Apply new silicon layer.
Silicon layer should cover the bolt hole & between bolt.

4.



Put the gasket. Item 2.
Put new flange glued (supply by WFE)

5.



Put washer & nut.
Tighten with torque wrench to 50 Nm.

SIGHT GLASS ASSEMBLY PROCESS (80MM)

1. Components

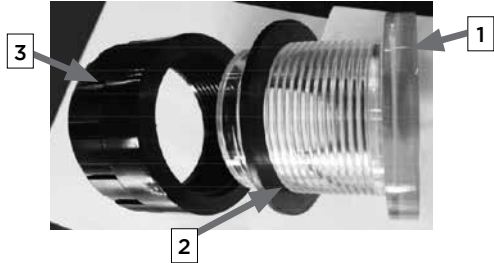

No	Code	Description	Req Qty
1	W22115	SIGHT GLASS 80MM WITH THREAD	1
2	W02250	GASKET 80MM BULKHEAD RUBBER	1
3	W02254B	BULKHEAD LOCK NUT 80MM BLACK	1

2. Smoothen gasket siting area with sand paper



3. Clean with acetone



4. Apply silicon



5. Place sight glass & push to filter wall



6. Hand tight with locknut



7. Fully tight with locknut spanner jig



WINTERISING

Proper winterising procedures should always be taken in order to protect your filter in cold climates [temperatures below freezing point]

1. Switch OFF the Pump / Close the Inlet/Outlet/Isolation valves
2. Open the air release valve and move the MPV handle to the winterise position [between Filter and Waste] This will allow air to through to all ports.
3. Remove any drain plugs from the filter
4. Drain water from the pipework

WARRANTY

Waterco fibreglass commercial vessels are covered by a 10 year (5 year full + 5 years pro rata) tank warranty and 1-year warranty on all other components.

Please refer to Waterco’s warranty terms and condition

OFFICES - AUSTRALIA

NSW - SYDNEY
(HEAD OFFICE)
Tel : +61 2 9898 8686

VIC/TAS - MELBOURNE
Tel : +61 3 9764 1211

WA - PERTH
Tel : +61 8 9273 1900

QLD - BRISBANE
Tel : +61 7 3299 9900

SA/NT - ADELAIDE
Tel : +61 8 8244 6000

ACT DISTRIBUTOR
Tel : +61 2 6280 6476

OFFICES - OVERSEAS

WATERCO (EUROPE) LIMITED
Sittingbourne, Kent, UK
Tel : +44 (0) 1795 521 733

WATERCO USA
Augusta, USA
Tel : +1 706 793 7291

WATERCO CANADA
Longueuil, Qc, Canada
Tel : +1 450 748 1421

WATERCO (NZ) LIMITED
Auckland, New Zealand
Tel : +64 9 525 7570

WATERCO (C) LIMITED
Guangzhou, China
Tel : +8620 3222 2180

WATERCO (FAR EAST) SDN BHD
Selangor, Malaysia
Tel : +60 3 6145 6000

PT WATERCO INDONESIA
Jakarta, Indonesia
Tel : +62 21 4585 1481

WATERCO SINGAPORE INTL PTE LTD
Nehsons Building, Singapore
Tel : +65 6344 2378

WATERCO

Waterco Limited ABN 62 002 070 733

