



www.the-mspa.com



## Owner's Manual

**P-SH063 Soho**

**P-CA043/063 Camaro**

**EN**

DO NOT RETURN MERCHANDISE TO YOUR DEALER STORE DIRECTLY. CALL MSPA AFTER SALES SERVICE CENTER FOR ANY PRODUCT-RELATED QUESTIONS OR CONTACT MSPA AT [info@the-mspa.com](mailto:info@the-mspa.com)

Due to MSPa continuous product improvement, MSPa reserves the right to change the product appearance and specifications, which may result in updates to the instruction manual without notice.



# ENTER THE WORLD OF MSPA

---

Welcome,

Thank you for choosing MSpa and for your confidence in our brand. We believe that you will enjoy many benefits of using MSpa products for years to come.

To guide you in your initial MSpa experience, we are pleased to present you with this instruction manual. Please read this manual carefully before using the product for the first time.

We are delighted to welcome you to the MSpa family, and look forward to sharing with you the full spectrum of our expertise.

Enjoy your MSpa!



MSpa official site



MSpa Set up videos



MSpa Service Center List



MSpa Owners Manual  
(Multi-language)

## CONTENT

---

Safety precautions.....	3
Specifications.....	7
Product overview.....	7
First use and set-up preparation.....	8
Spa set-up.....	9
Wired controller operation.....	12
Water maintenance and chemicals.....	13
Drainage, cleaning and storage.....	15
Precautions for seasonal use.....	16
Disposal and environmental protection.....	16
Troubleshooting.....	17
Mspa limited warranty.....	19

## SAFETY PRECAUTIONS

---

For your own safety and that of your product, please make sure to follow the safety precautions below. Failure to follow the instructions may result in serious injury, property damage or death. Improper installation or operation will void the warranty.

**PLEASE ENSURE THAT YOU READ, UNDERSTAND AND FOLLOW  
ALL INSTRUCTIONS KEEP THIS MANUAL FOR FUTURE REFERENCE**

### DANGER

- Risk of Accidental Drowning. Extreme caution must be exercised to prevent unauthorized access by children.
- Risk of drowning. Inspect the spa cover regularly for leaks, premature wear and tear, damage or signs of deterioration. Never use a worn or damaged cover as it will not provide the level of protection required to prevent unsupervised access to the spa by a child.
- Risk of drowning. Always lock the spa cover after each use.
- Risk of injury. The suction fittings in this spa are sized to match the specific water flow created by the pump. Never operate the spa if the suction fittings are broken or missing. Never replace a suction fitting with an incompatible one.
- Risk of injury. If the supply cord is damaged, it must be replaced by the manufacturer, a service agent or a similarly qualified person in order to avoid hazards.
- Risk of Electric Shock. Do not permit any electrical appliances, such as lights, telephones, radios or televisions, within 1.5m (5 feet) of a spa tub.
- Risk of Electric Shock. Do not use the spa when it is raining, thundering or lightning.

### WARNING

- To reduce the risk of electric shock, do not use an extension cord, timers, plug adaptors or converter plugs to connect the unit to the electrical supply; provide a properly located outlet.
- This appliance with its incorporated heating elements must be connected to a grounded mains supply socket with a supply cord fitted with a plug and a PRCD (portable residual current device) with a tripping current of 10mA.
- This appliance with earthing must only be plugged directly into an earthed socket-outlet for fixed wiring.
- Parts containing live components, except those parts supplied with safety extra-low voltage not exceeding 12V, must be inaccessible to anyone using the spa.
- Parts incorporating electrical components, except remote control devices, must be located or fixed so that they cannot fall into the spa.
- Electrical installation should fulfill the local requirement or standards.
- The wired controller must be properly stored in the side pocket when not in use, to protect it from falling or other hazards.
- To reduce risk or injury, keep children away from this product unless they are closely supervised at all times.
- To reduce the risk of child drowning, supervise children all times. Children under 10 years should be under the active supervision of a person 16 years or older whilst in spa pool area. Attach and lock the spa cover after each use.
- The appliance is not to be used by persons (including children) with reduced physical, sensory or mental capabilities, on lack of experience and knowledge, unless they have been given supervision or instruction.
- Children being supervised not to play with the appliance.
- Make sure that the floor is able to support the expected load, which can be found on the specifications sheet. You will need to calculate the expected water capacity load plus the total weight.

- An adequate draining system must be provided around the spa to deal with overflow water.
- To reduce the risk of injury:
  - a) Lower water temperatures are recommended for young children and when spa use exceeds 10 minutes. In order to avoid the possibility of hyperthermia (heat stress) occurring, it is recommended that the average spa-pool water temperature does not exceed 40°C (104°F).
  - b) Since excessive water temperatures have a high potential for causing fetal damage during the early months of pregnancy, pregnant or possibly pregnant women should limit the spa water temperature to 38°C (100°F).
  - c) Before entering the spa or hot tub, the user should measure the water temperature with an accurate thermometer since the tolerance of water temperature regulating devices may vary.
  - d) The use of alcohol, drugs or medication before or during spa use may lead to unconsciousness with the possibility of drowning.
  - e) The use of alcohol, drugs or medication can greatly increase the risk of fatal hyperthermia in spas.
  - f) The causes and symptoms of hyperthermia may be described as follows: Hyperthermia occurs when the internal body temperature reaches a level several degrees above the normal body temperature of 37°C (98.6°F). The symptoms of hyperthermia include an increase in the body's internal temperature, dizziness, lethargy, drowsiness, and fainting. The effects of hyperthermia include a failure to perceive heat; a failure to recognize the need to exit the spa; an unawareness of impending hazards; fetal damage in pregnant women; a physical inability to exit the spa; and unconsciousness resulting in the danger of drowning.
  - g) Obese persons or persons with a history of heart disease, low or high blood pressure, circulatory system problems, or diabetes should consult a physician before using a spa.
  - h) Persons using medication should consult a physician before using a spa since some medication may induce drowsiness or affect the heart rate, blood pressure, or circulation.
  - i) Check with a doctor before use if pregnant, diabetic, in poor health, or under medical care.
- A recommendation that owners of spa pools learn a recognized resuscitation technique.
- This spa pool is a heated water environment and if you are concerned that it may adversely affect you it is your responsibility to seek medical advice.
- It is recommended that you use the spa pool for no longer than 15 minutes at a time.
- People with an infectious disease should not use a spa or hot tub.
- To avoid injury, exercise care when entering or exiting the spa or hot tub.
- Water temperatures in excess of 40°C (104°F) may be injurious to your health.
- Never use a spa or hot tub alone or allow others to use the spa alone.
- Do not use a spa or hot tub immediately following strenuous exercise.
- Spa heat in conjunction with alcohol, drugs, or medication can cause unconsciousness.
- Exit immediately if uncomfortable, dizzy, or sleepy. Spa heat can cause hyperthermia and unconsciousness.
- To prevent freezing, the spa must not be exposed to temperatures below 0°C (32°F) if there is still water in the pool. It is helpful to place a temperature barrier mat between the spa pool and the ground. A similar mat made of foam or any other material with a heat barrier function can also be used. Do not turn on the spa when the water is frozen.
- Never pour water with a temperature higher than 40°C (104°F) into the spa directly.
- Always unplug the product from the electrical outlet before removing, cleaning, servicing or making any adjustments.
- Never jump or dive into a spa or any shallow body of water.
- No part of the electric appliance is to be located above the bath during use.
- Do not bury the electrical cord. Locate the cord where it will not be damaged by lawn mowers, hedge trimmers or any other equipment.
- Do not attempt to plug in or unplug the product while standing in water or when your hands are wet.
- Do not use the spa if it is damaged on delivery and/or if it malfunctions in any way.
- Contact the MSpa service center for further instructions.
- Keep all pets away from the spa to avoid any damage.

- Do not add bath oil or bath salt to the spa water.
- NEVER PUT HEAD UNDER WATER.
- Avoid swallowing the spa water.

## CAUTION

- Always add chemicals to water, never add water to chemicals. Adding water to chemicals may cause strong fumes or violent reactions and hazardous chemical spray.
- For water that has already been used, dispose of it promptly or use water chemicals for cleaning. Usually, it is recommended to drain and refill a spa with clean water every 3-5 days.
- Use the chemical kit for disinfection in accordance with manufacturer's instructions.
- Do not leave or set up the spa with a temperature lower than 4°C (39°F) if the heater is not operating.
- Always enter and exit the spa or hot tub slowly and cautiously. Take extra care if the floor is wet.
- To avoid damage to the pump, never turn on the spa or hot tub if it is not filled to the minimum water line.
- The spa or hot tub must only be placed on a properly prepared site that meets the floor loading requirement.
- Do not leave the spa empty for an extended period of time. Drain the spa completely if it is not going to be used for a long period of time. Do not expose the spa to direct sunlight. Check regularly before each use. When the spa is not in use, store it away immediately or keep it in an enclosed area.
- Open the spa top lid when the Bubble function is on.
- In order to avoid a hazard due to the inadvertent resetting of the thermal cut-out, this appliance must not be supplied through an external switching device, such as a timer, or connected to a circuit that is regularly switched on and off by the utility.
- Once the spa is installed, refer to the relevant chapters for details concerning cleaning, periodic checks and other maintenance.

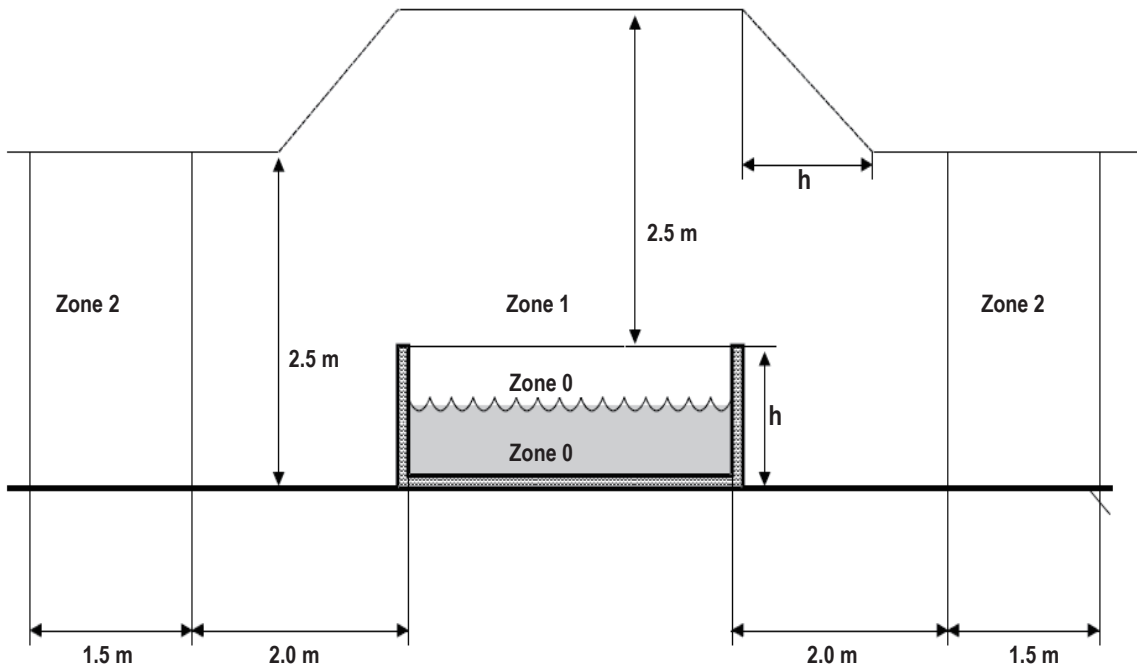

**Warning:** The appliance's water protection levels vary across different product zones, as shown in the following diagram. (The installation regulations comply with IEC 60364-7-702.)



**NOTE -** The measured zone dimensions are limited by walls and fixed partitions.

Zones	Description of the zones
Zone 0	Zone 0 is the interior of the basin including any recesses in the walls or floor.
Zone 1	Zone 1 is limited by <ul style="list-style-type: none"> <li>• Zone 0</li> <li>• A vertical plane 2m from the rim of the basin.</li> <li>• The floor or the surface expected to be occupied by the users.</li> <li>• The horizontal plane 2.5m above the floor or the surface.</li> </ul>
Zone 2	Zone 2 is limited by <ul style="list-style-type: none"> <li>• A vertical plane external to zone 1 and a parallel plane 1.5m from the former.</li> <li>• The floor or surface intended to be occupied by the users.</li> </ul>







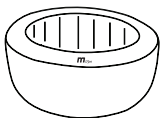

# SPECIFICATIONS

BUBBLE SPA								
Model No. / Code	Shape	Seating Capacity	Water Capacity	Outside Dimensions	Inside Dimensions	Height	Weight	Temp Increasing Rate
P-SH063 / SOHO	Square	6 	930Ltr (245gal)	1.85m (73")	1.45m (57")	0.68m (27")	34kg (75lbs)	1.5-2.0 °C/h
P-CA043 / CAMARO	Round	4 	700Ltr (184gal)	1.80m (71")	1.40m (55")	0.70m (28")	30kg (66.1lbs)	1.5-2.0 °C/h
P-CA063 / CAMARO	Round	6 	930Ltr (245gal)	2.04m (80")	1.60m (63")	0.70m (28")	33.5kg (73.9lbs)	1.2-1.8 °C/h

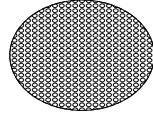
Control System Specs	SH063 / CA043 / CA063
Control System	AC 220-240V~ 50Hz
Total Power	2300W
Heater	1500W
Massage Air Blower	720W
Filter Pump	1800L/h
Top Lid	Premium PVC leather cover with foil inside
Pool Cover	Premium PVC tough leather, waterproof and anti-UV
Pool Material	Premium PVC fabric

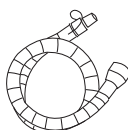
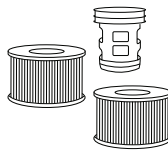
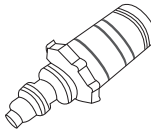
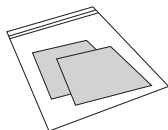
# PRODUCT OVERVIEW

## Packaging contents

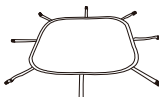
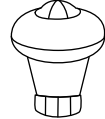
A. 	B. 	C. 	D. 	
F. 	G. 	H. 	I. 	J.  * Round or square
K. 	L.  Only for P-SH063 * Buckle spa cover	 * Ground mat	M. 	

NOTE: Drawings for illustration purpose only. The actual product may vary. Not to scale.

REF. NO.	PARTS DESCRIPTION	QTY.
A	Spa cover with aluminum foil inside (Soho P-SH063 comes with a ground mat with the cover)	1
B	Spa tub	1
C	Wired controller	1
D	Heat preservation bubble mat (For P-CA043/063)	1
E	Digital lock (except for Soho P-SH063)	1
F	Inflation hose for bladder	1
G	Filter cartridge*2, cartridge base*1	1
H	Spa drain valve adaptor	1
I	Repair kit	1
J	Inflatable bladder	1
K	Wrench	1
L	Buckle spa cover and ground mat set (only for P-SH063)	1
M	Chemical Dispenser for 1" tablets	1

**NOTE:** When ordering parts, be sure to quote the model number and description.

## FIRST USE PREPARATION AND SET-UP

### Site preparation and requirements

- The spa can be installed indoors or outdoors in around 10 minutes by one or more persons. For household use only.
- The spa must be set up on a flat, smooth and supporting surface that is able to bear the maximum load of the filled spa with the listed maximum number of occupants. Check with a qualified contractor or structural engineer to verify the requirement.
- Make sure the area is free of sharp objects under or around the spa. Uneven or unsound surface can damage the spa and void your warranty. Level the surface before filling the spa with water.
- Provide an adequate drainage system around the spa to deal with overflow water and splashes. Provide a convenient water supply for filling the spa that complies with any local water regulations, and whose parameters shall be adjusted with the requirements of the water treatment section.
- Make sure there is enough clearance around the spa for full access to the equipment for maintenance and/or servicing.
- Consider positioning the spa to minimize noise disturbance as much as possible.

### Additional requirements for indoor installation

- Humidity is a natural side effect of indoor spa installation. The room must be properly ventilated to allow moisture to escape. Install a ventilating system to prevent excess condensation moisture in the room.
- Ensure the spa can be removed from the building without destroying any part of the built structure.
- Consider any local regulations on these topics.
- Consider not to install the spa on carpet or other floor materials that promote or harbor moisture and bacterial, or that could be affected by water treatment chemicals used in the spa.

### Additional requirements for outdoor installation

- Do not set up the spa on grass or dirt, as this will increase the amount of debris entering the spa and will damage the floor.
- To ensure a longer lifespan, do not leave the spa tub exposed to direct sunlight.
- Always keep the manometer within the yellow section when using the spa at a temperature higher than 20°C (68°F) or when exposing it to sunlight for a short time.
- Do not install or use the spa outdoors at a temperature lower than 4°C (39°F). Do not use the spa when the water inside the circulation system, pump, or pipework is frozen. Put a heat preservation mat (optional accessories) between the base of the spa and the ground to prevent heat loss from the bottom of the spa and to provide better heat retention.
- Consider local environmental conditions, such as ground water and risk of frost.

### PRCD Testing

#### WARNING

Risk of electric shock: This product is provided with a PRCD located at the end of the power cord. The PRCD must be tested before each use. Do not use the spa if the PRCD does not function properly.  
Disconnect the power cord until the fault has been identified and corrected. Contact a licensed electrician to correct the fault. There are no serviceable parts inside the PRCD. Opening the PRCD will void the warranty.



1. Plug the machine into the mains.
2. Press the **RESET** button on the PRCD. The indicator turns red.
3. Press the **TEST** button on the PRCD. The red color shown on the indicator should disappear. Otherwise the PRCD is faulty. Do not use the spa if the spa is faulty. Contact a qualified electrician to correct the fault.
4. Press the **RESET** button on the PRCD again. The indicator should turn red. When it does, the spa is ready for use.

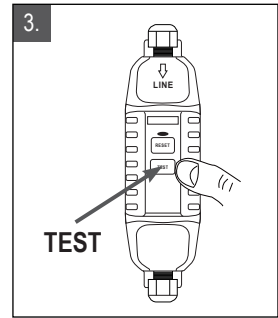
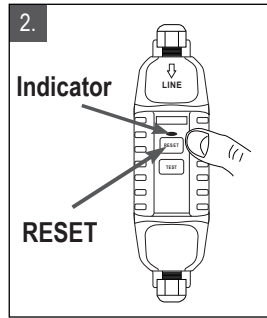
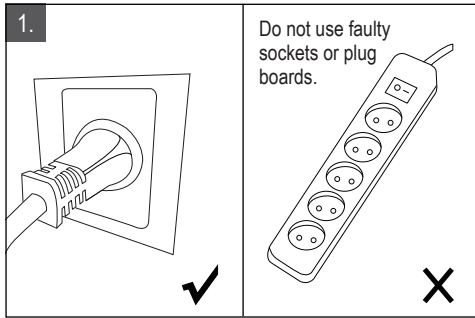

### Spa Control Unit Connected External Equipotential Bonding Conductors

A qualified electrician should wire the spa control unit to the household equipotential terminal using a minimum 1.5mm<sup>2</sup> solid copper conductor.

## SPA SET-UP

1. Move the entire package to the selected site. Open the carton carefully as it can be used to store the spa during long term storage or when not in use.
2. Lay out all the parts on the ground and make sure all parts are accounted for. Make sure the spa tub is right side up. (\*For missing or damaged part, contact the MSpa Service Center)
3. Spread the Heat Preservation Ground Mat over a cleared area. Spread out the spa liner over the ground mat. The heat Preservation Mat prevents heat loss from the bottom of the unit.

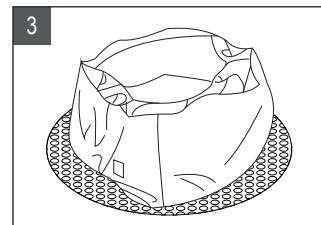
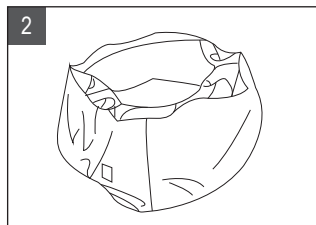
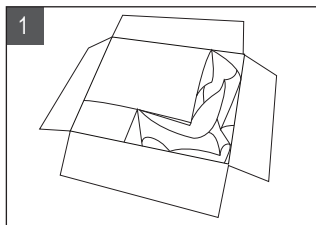

- **NOTE:**  
**SOHO P-SH063:** Spread out the square ground mat and place it to the selected site. Make sure the buckle of cover and mat is attached when the spa is not in use.

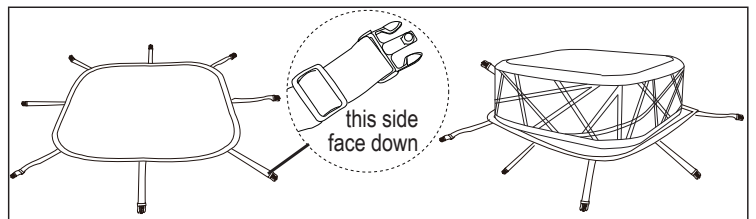

### Heater Resetting:

Please reset the heater when the product is used for the first time or after a long period of storage.

**Operation:** Find the yellow ring as shown in the picture. Pull it down gently and then release it.

**NOTE:** The heater cannot work or be reset when the water temperature or ambient temperature is higher than 40°C (104°F).

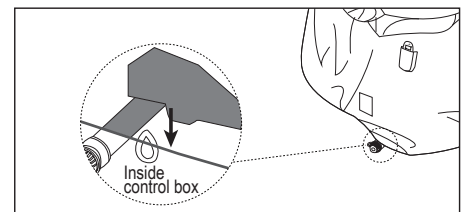

#### 4. Spa Inflation

- 4.1 Plug the spa into the grounded supply socket.
- 4.2 Press the RESET button on the PRCD, the screen on controller shows numbers.
- 4.3 Turn the inflation knob to the inflation status <ON> and long press ( $\geq 2$  minutes) the bubble button on the controller to start inflating until the **yellow** section of the manometer is pushed out.
- 4.4 Stop pressing the bubble button and turn the knob back to <OFF> for activating other functions.

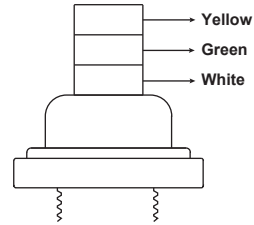
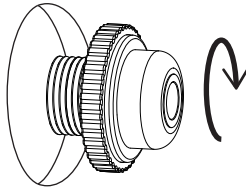
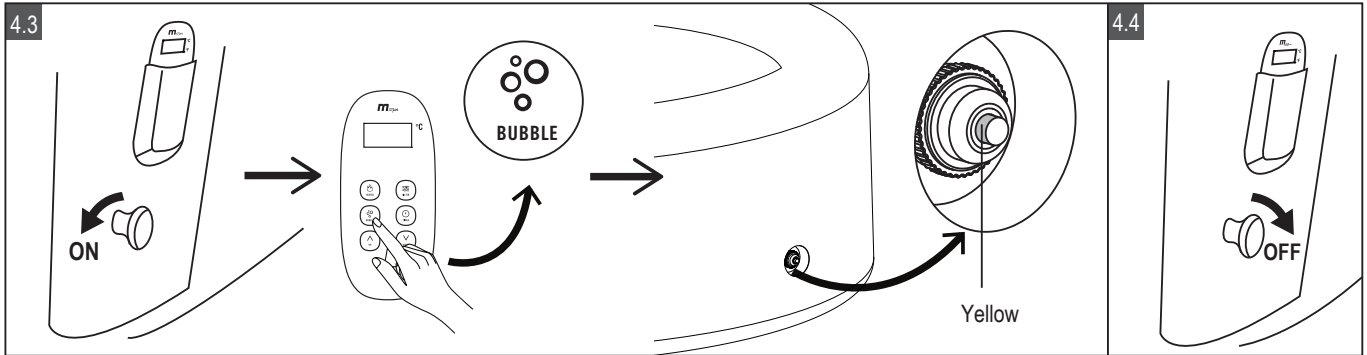

**Note:**

**Before inflation, check whether the manometer cap is screwed up tight on the valve of pool body. If not, please tighten and then inflate. After inflation, the manometer cannot be removed, otherwise the air will be released.**



When the **Yellow** section is pushed out, the Spa inflation is completed. You can fill the Spa with water.

After water filling is completed, check the air pressure once again to ensure the manometer reaches its **Green** section. Always ensure the manometer is in the **Green** section during use.

If the **White** section of the manometer appears, the spa is over inflated. Rotate the valve cap counter clockwise, have the air released till the **Green** section is pushed out, then tighten it clockwise.

To avoid over inflation caused by warm weather or sunshine when leaving spa for weeks inflated and filled with water in temperature higher than 20°C (68°F), please release some air to make sure the manometer is always on in the **Yellow** section.

#### 5. Spa Bladder Inflation.

- 5.1 Open the air valve (C) on the spa pool. Make sure you choose the correct one in black color. Open the air valve (a) on the bladder. Insert the inflation hose (b) into the valve.
- 5.2 Press the Bubble  button to inflate until the bladder is firm to touch but not hard.
- 5.3 Press Bubble  button for more than 3 seconds to turn off the function. Disconnect the inflation hose from the air blower outlet and the valve.
- 5.4 Replace the air valve cap (c) back. Close and recess the inflation valve (a).

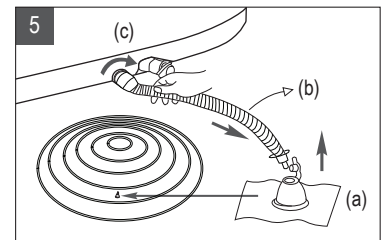

#### 6. Water Filling

- 6.1 Check the spa mark is at the selected area and point the drain valve toward a suitable draining area before inflation.
- 6.2 Fill the spa tub with fresh water to a level between **Minimum** and **Maximum** line marked on the inside of the spa wall. Do not over fill the spa. It is recommended to fill the spa with lukewarm water for quick heating and energy saving. Using tap water for spa filling to minimize the influence of unwanted content, such as minerals.

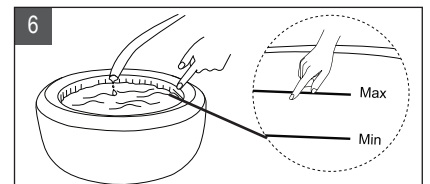

**WARNING:**

- The water level must reach the Minimum water line but not exceed the Maximum line to avoid pump failure.
- Never pour water with a temperature higher than 40°C (104°F) directly into the spa.
- To avoid control system failure, do not operate the spa until water reaches the Minimum line.

6.3 After water filling, double check the spa pool air pressure to make sure the manometer points out to the Green section.

6.4 Install the filter cartridge. Please refer to the instruction on P13.

6.5 Place the inflated air bladder and the zipper spa cover over the spa tub. Make sure the spa cover is zipped and locked by the digital lock in the accessory pack.

**IMPORTANT:**

- Inspect the spa pressure regularly for leak, premature wear, or deterioration.
- Check and wax the zipper regularly, to make it smooth for operation and to avoid splits.
- Always keep the spa cover on to minimize heat loss when heating the water.
- Make sure the cover, and mostly its side facing water, will not come into contact with the ground or any other dirt when not in use.
- Covers shall be cleaned inside and out periodically using a suitable solution that includes adequate disinfection (e.g. 10ml/l of free Chlorine).

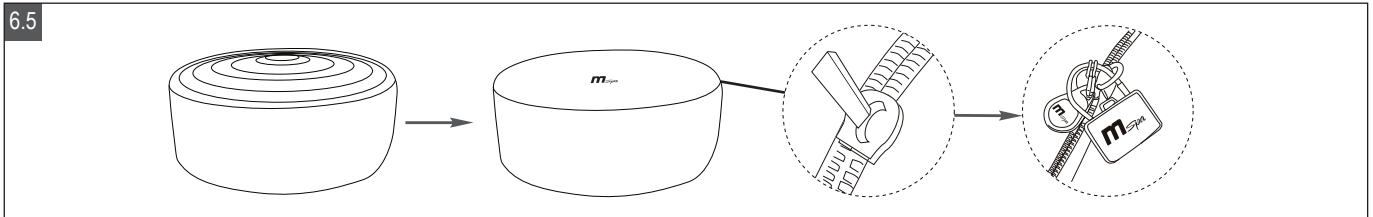

6.6 Turn on the Heater on the spa wired controller, refer to the “Wired Controller Operation” section. Maximum heating temperature is 40°C (104°F).

## 7. Zipper and Buckle Operation

### 7.1 Digital Lock Operation

The default password is “000”. Follow the steps below to change the password:

- Push the button (a) in the direction of Fig.7.1.(1) to unlock the digital lock.
- Set your preferred password in 3 digits by turning the number wheel (b), see Fig.7.1.(2).
- Insert back the cable (c). The new password is set.

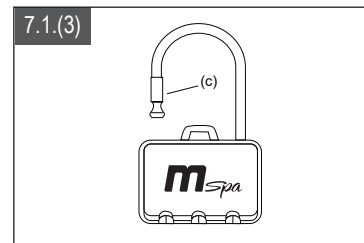
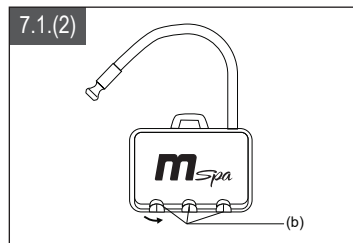
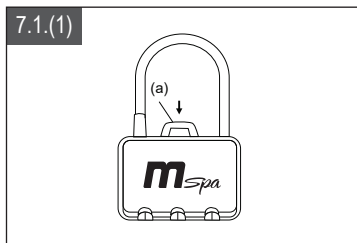

### 7.2 Square Spa Buckle Lock Operation

#### Lock the Buckle

- Insert the buckle on the Ground Mat into the Spa cover buckle, until you hear a “Click” sound.

#### Unlock the Buckle

- Pinch both sides of the locked buckle, and press down the round dot in center in the same time. Press down the center button and release the lock.

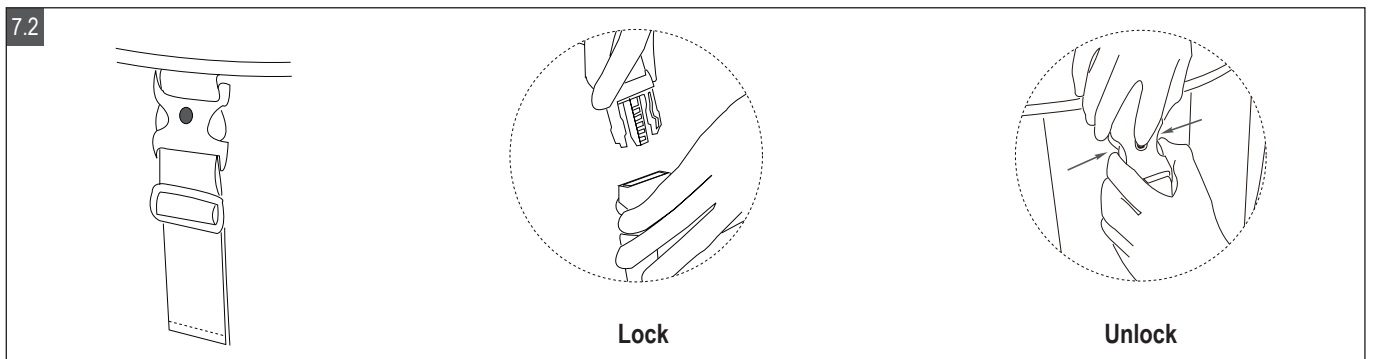

# WIRED CONTROLLER OPERATION

---

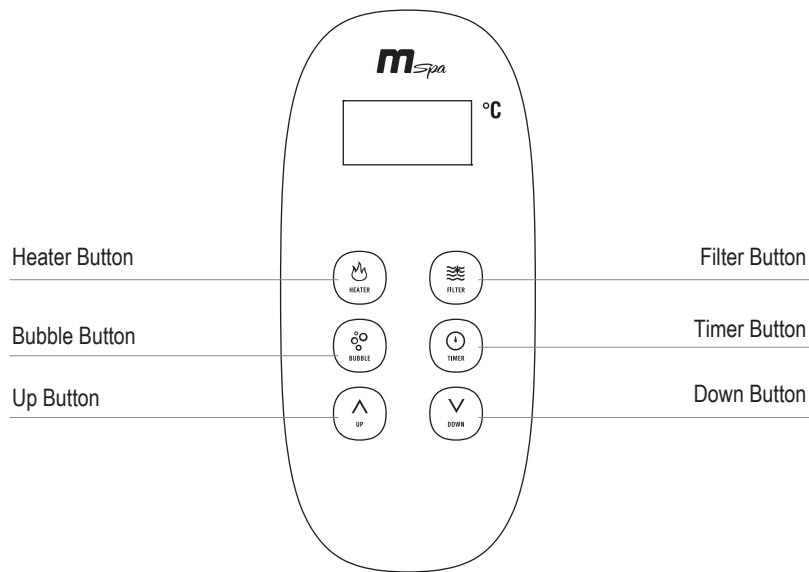



## LED display

Once powered-up, press the **RESET** on the PRCD. The LED displays the current water temperature automatically.

**NOTE:** The actual water temperature may vary from the temperature displayed on the LED screen by as much as approximately 1°C.

## HEATING

20-40°C

1. Press the  **HEATER** button to turn the heating system on/off. When the light above the heat button is red, the heating system is activated. When the light is green, the water is at the set temperature and the heating system is at rest.
2. Pressing the  **UP** or  **DOWN** button will cause the LED to flash. When it is flashing you can adjust the water to the desired temperature setting (from 20°C to 40°C). The new and desired temperature setting will remain on the LED display for 3 seconds to confirm the new value.

**NOTE:** The default temperature is 40°C.

**NOTE:** If the heating system is turned on, the filtration system will automatically start.

**NOTE:** When the water temperature is below 1°C (33.8°F), the anti-icing system will be activated automatically to heat the water to 3°C (37.4°F).

**IMPORTANT:** The following conditions will lead to slow water heating

- An ambient temperature lower than 10°C (50°F).
- An outdoor wind speed above 3.5-5.4m/s (8-12mph).
- If the air bubble function is activated when the heater is on.
- If the spa cover is not properly in place when the heater is on.

## FILTRATION

Press the  **FILTER** button to turn the function on/off. The light turns to green when the function is activated.

**NOTE:** The filtration system will automatically start when the heating, Ozone is activated.

**NOTE:** After turning off the heating system, the filtration system will automatically stop in 30 seconds.

**Filter Cartridge Cleaning Reminder:** When the FILTER button is flashing or displays red, the filter cartridge must be cleaned or replaced. Once this has been done, press the Filter button for 3 seconds to reset the reminder.

**Auto-filtration:** When the spa is in stand-by mode, the filtration system will operate automatically for 60 minutes every 8 hours.

## BUBBLE MASSAGE

Press the  **BUBBLE** button to turn the massage system on/off. The Bubble button displays green when activated.

**IMPORTANT:** Do not turn on the massage system when the cover is attached. Air can accumulate inside the spa and cause irreparable damage and bodily harm.

**NOTE:** The bubbling massage function will shut down automatically after every 20 minutes of operation as a safety precaution. This can be reactivated after 10 minutes by pressing the BUBBLE button again.

**Attention:** The bubble function can only be activated when the inflation knob is in <OFF> position.



## HEATING TIMER

1-99H

To set the number of hours **FROM NOW** when the heater will activate:

1. Press the **TIMER** button to enter pre-setting mode. The button displays green.
2. Pressing the **UP** or **DOWN** button will cause the LED to flash. While it is flashing, you can adjust the number of hours before heater activation (from 1 to 99 hours). The desired timer setting will remain on the LED display for 3 seconds to confirm the value.

**To modify the timer setting:** Press the **Timer** button again and use the **UP** or the **DOWN** button to adjust.

**Cancel the setting:** Press the **TIMER** button for 3 seconds.

**NOTE:** Activating the heating system or rebooting the spa will cancel the timer setting.



## SAFETY LOCK

3s

Press the **UP** and **DOWN** buttons at the same time for 3 seconds to lock/unlock the controller. In safety lock mode, the controller is disabled and the spa retains all previous settings.

# WATER MAINTENANCE AND CHEMICALS

**CAUTION: ALWAYS ENSURE THE SPA IS UNPLUGGED BEFORE BEGINNING ANY MAINTENANCE WORK TO AVOID THE RISK OF INJURY OR DEATH.**

## FILTER CARTRIDGE MAINTENANCE

1. Inspect and clean the filter cartridge gently after each use. Follow the steps below:

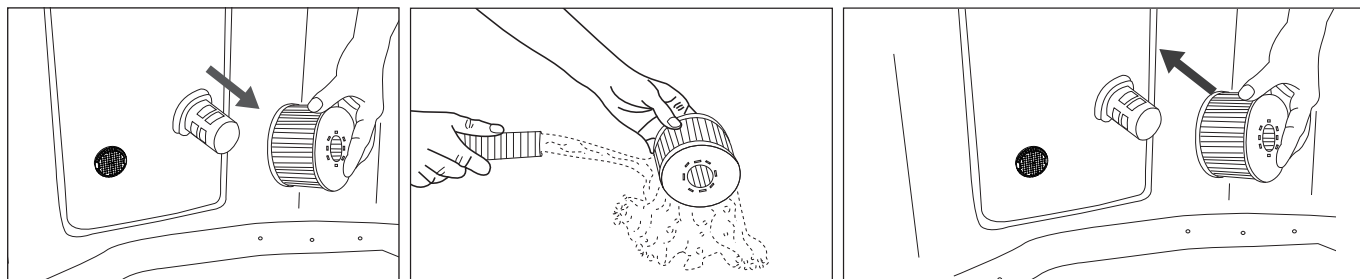

**NOTE:** Change the filter cartridge every 3-5 days, or if the filter cartridge remains soiled and discolored.

**NOTE:** When the spa is filled with water, there should always be a filter cartridge installed on the base.

**NOTE:** Turn off all the functions before changing or cleaning the filter cartridge.

2. If the spa's inlet or outlet becomes clogged with dirt, use the wrench to unscrew the cap and then clean as necessary.

**NOTE:** Before unscrewing the part, make sure the spa is empty. Never unscrew it when the spa is filled with water!

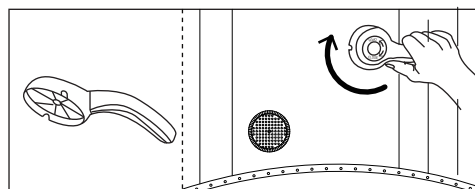

## SPA WATER

1. Change the spa water every 3-5 days depending on use. If dirt is visible in the water or if the water becomes cloudy and the correct water chemistry does not clear it up, change the water and clean the spa tub. See the "Cleaning, draining and storage" section for instructions.
2. We recommend taking a shower before using the spa, as cosmetic products, lotions and other residues on the skin can quickly degrade the water quality.
3. When the spa is not in use, cover it with the buckle cover to prevent pollution.
4. Use spa chemicals to maintain the proper water conditions. Spa damage resulting from the misuse of chemicals or the mismanagement of spa water is not covered by the warranty. Consult with your local spa or pool retailer for more information on chemical use.

## Water Sanitation

The spa owner must regularly check and keep the spa water sanitized with scheduled maintenance (daily, if necessary). Adding sanitizer or other chemicals will control bacteria and the reproduction of viruses in the spa water. Maintaining the correct water balance through the appropriate use of sanitizers is the most important factor in maximizing the life and appearance of the spa and ensuring clean, healthy and safe water.

Adopting the proper technique is important for testing and treating the spa water. Contact your spa professional if you have any questions on chemicals, sanitizers, test kits or test procedures.

## Water Balance

Follow the instructions below to maintain your spa water.

PARAMETER	TEST FREQUENCY	CORRECT LEVEL
pH	Daily	7.2-7.6 when using Chlorine; 7.2-7.8 when using Bromine
Free Chlorine	Daily	3-5 ppm
Bromine residual	Daily	2-4 ppm
Total Alkalinity (TA)	Weekly	80-120 ppm
Total Hardness (TH)	Weekly	200-500 ppm

**NOTE**

- A low pH will damage the spa tub and pump. Any damage resulting from a chemical imbalance will void the warranty.
- A high pH (hard water) will result in white coagulations inside the filter pump, which may lead to pump damage.

**Water Treatment:**

- It is good practice with an existing spa to keep all air jets open and valves closed to allow chemically treated water to flush through all pipework.
- Always follow the chemical manufacturer’s directions, and the health and hazard warning.
- Never mix chemicals together. Add the chemicals to the spa water separately. Thoroughly dissolve each chemical before adding it to the water.
- Please note that chlorine and bromine products should never be mixed. This is extremely dangerous. If you usually use chlorine-based products and you want to switch to bromine-based products, or vice versa, it is essential that you change the spa water first.
- Do not add chemicals if the spa is occupied. This can cause skin or eye irritation.
- Do not overuse chemicals or use concentrated chlorine. This can damage the spa tub and cause potential hazard to your skin. Improper chemical use will void the warranty.

**Floating Dispenser**

Your spa comes with a standard chemical dispenser: This dispenser only applies to 1" tablet. Do not pour liquid or granules into the dispenser.

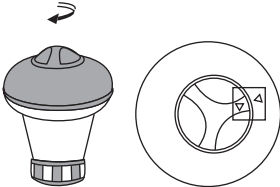

Rotate the upper cap counter-clockwise until two arrows meet. Remove the cap.

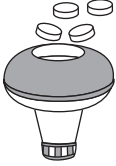

Put in chemical tablets. Please refer to the package or manual of the chemical you purchased for proper dosage.

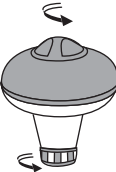

Rotate the upper cap clockwise. Adjust the dosage by rotating the bottom cover to open or close the dispenser holes.

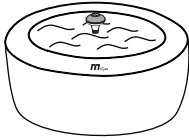

Put the dispenser in the spa. Make sure the filter pump is running during the sanitizing process.

# DRAINAGE, CLEANING AND STORAGE

## Spa Drainage

1. Turn off all the functions.
2. Connect the drain valve adaptor to a garden hose and point the other end of the garden hose to a suitable draining area.
3. Remove the drain valve cap from the outside of the spa tub and attach the drain valve adaptor to the drain valve.
4. On the inside of the spa tub, open the drain valve cap. Water will start flowing out from the garden hose.
5. When the water stops draining, lift the spa tub wall from the side opposite the drain, directing any remaining water to the drain and emptying the spa completely.
6. Press the BUBBLE button to dry the spa pool.
7. Use a clean towel to wipe up any remaining water and moisture on the spa tub and spa control unit. Ensure the spa tub and spa control unit are thoroughly dried.

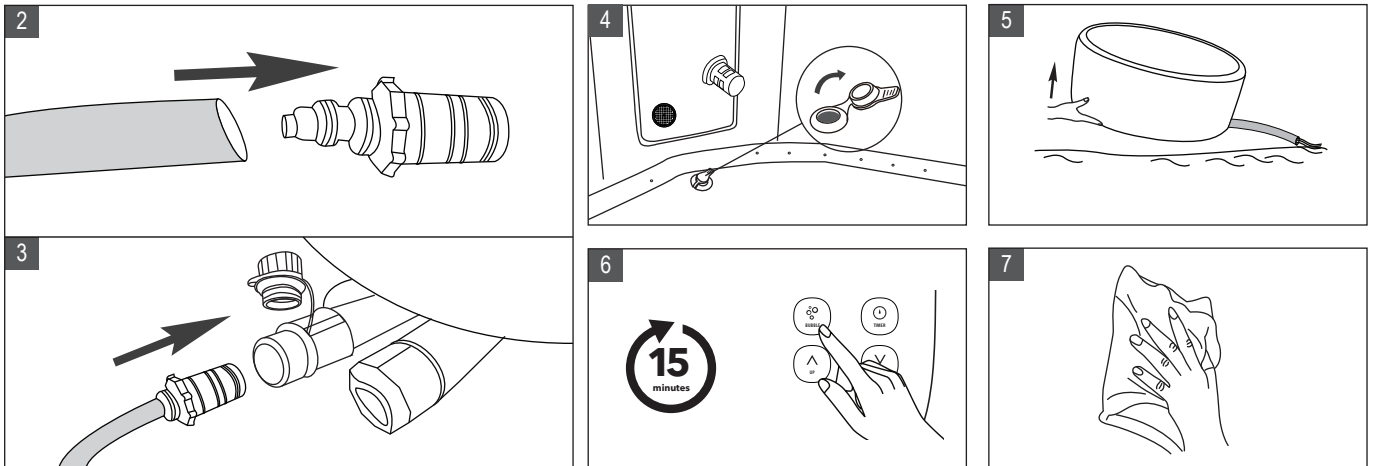

## Cleaning The Spa Tub

If dirt is visible in the water or if the water becomes cloudy and the correct water chemistry does not clear it up, change the water and clean the spa tub. See the "Spa tub drainage" section on how to drain the spa. While empty, clean and/or replace the filter cartridge. Use a sponge and mild soap solution to wipe away any soil or stains on the inside of the spa wall. Rinse thoroughly before refilling with clean water.

**IMPORTANT:** Do not use steel wool, hard brushes or abrasive cleaners.

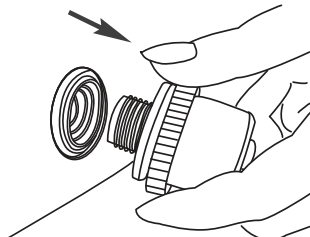

### Deflation Instructions

#### Spa deflation

1. Unscrew the valve completely to deflate the spa.
2. Once deflation is completed, replace the cap.

#### Spa Bladder Deflation

1. Open the valve cap to deflate the bladder. For quick deflation, insert the straw (included in the repair kit) into the valve.
2. Once the deflation is completed, re-place the cap back.

## Spa Tub and Air Bladder Repair

Use the enclosed repair patch to repair any puncture:

1. Clean and dry the area to be repaired thoroughly
2. Apply the glue to the PVC patch and quickly attach it onto the damaged surface. (Glue is not included)
3. Smooth the surface to remove any air bubbles and allow it dry for 5-10 minutes

**NOTE:** Glue is not included.

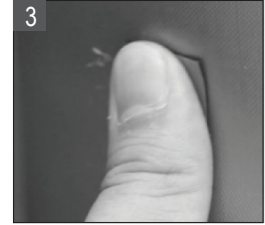
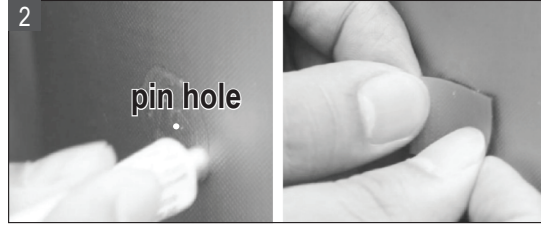

## Storage and Preparation for Future Use

1. Drain and clean the spa by following the “Drainage” and “Spa Cleaning” sections.
2. Refer to the instructions to deflate the spa tub and air bladder.
3. Make sure all the spa components and accessories are thoroughly clean and dry before storage. Air-dry the spa tub in the mild sun for an hour before folding.
4. Fold the spa tub loosely and avoid any sharp corners to prevent damage or leakage to the spa liner.
5. Prepare new additional cartridge for next time use.
6. Store the spa and accessories in a dry, temperature-controlled environment, between 0°C and 40°C (32°F - 104°F). We recommend storing the spa with desiccant.
7. The original packaging is recommended for storage.
8. After long-term storage, fill the spa with clean water and sanitizer, and turn on the FILTER for at least 1 hour before use.

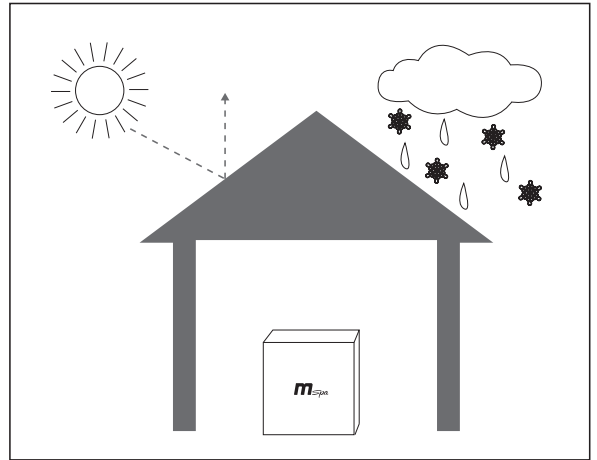

## PRECAUTIONS FOR SEASONAL USE

---

Inflatable hot tubs are made of reinforced PVC material, whose nature decides the hot tubs are easily affected by weather and temperature. Please do pay special attention when using the spa under different seasonal conditions.

### In Summer / Sunny days

Direct sunshine and hot weather will both lead the spa liner to expand.

- To extend the service life of the spa, it is suggested to place the spa in a sheltered place.
- Please check the air pressure regularly. The manometer should always point to the Green section when spa is filled with water. When leaving the spa outdoors unattended for long periods of time, release some air until the manometer points to the Yellow section. This will prevent the spa liner from expanding too much due to rising temperature during the daytime.
- To protect your skin from sunburn, it is highly recommended to enjoy the spa in the morning or evening when the sunlight is milder and temperature is more comforting.
- Check the water temperature and consider lowering it for the times when the spa is not in use. Turn off the heater entirely if not using the spa for an extended period of time.

### In Winter

#### Inflation

Low temperature will harden the PVC material and make it more fragile.

- The new spa might have been stored or transported at a low temperature (below 4°C / 39°F) before it is unfolded. Put the package indoors or somewhere warm for 12 hours to soften the material before use.
- The lower the temperature is, the more air the spa tub will require, and the longer the inflation will take. After water is heated to a much higher temperature, the air inside the chamber will get swollen. To shorten the inflation period, and to reduce the expansion of the spa liner, we suggest inflating the spa at a temperature higher than 15°C / 59°F. If the ambient temperature is below 0°C / 39°F, the spa should not be inflated.



## Heating and Heat Preservation

In cold weather, heating the water up will take much more time. It is suggested to:

- Fill the spa tub with lukewarm water (not higher than 40°C / 104°F) to get it heated it more quickly.
- Use ground mat and inflatable bladder for better heat preservation effect.
- When the outdoor temperature is below 4°C(39°F), even when not using the spa, as long as it is filled with water, the heater should always be turned on (or put the spa in stand-by mode) to prevent water from freezing.
- Your spa is equipped with an Anti-icing System. Put the spa in stand-by mode, when the water temperature falls below 1°C/33.8°F, the heater runs automatically until the water is heated up to 3°C/37.4°F. This will help prevent water from freezing. If you are not going to use the spa in near future, please disassemble the spa and store it following the storage procedure.

## In Rainy days

For the spa that is placed outdoors, do not use it when it rains.

If the spa is placed under rain shelter, do not turn on the bubble function. This is because the rain in the nearby air will also be sucked into the pump, causing the bubble generator to get damp and rusty which could result in malfunction and void your warranty.

It is recommended to put the plug and socket somewhere not exposed to rain to prevent damage caused by water accumulation due to excessive rain.

## DISPOSAL AND ENVIRONMENTAL PROTECTION



This marking indicates that the product should not be disposed of with other household waste. To prevent possible harm to the environment or human health from uncontrolled waste disposal, recycle the product responsibly to promote the sustainable reuse of material resources. Information on disposal can be obtained from your local authorities.

To return your used device, please use the return and collection systems or contact the retailer where the product was purchased for environmentally safe recycling.

## TROUBLESHOOTING

### ERROR CODE CHART

LED READING	CAUSE	SOLUTION
F0	Water temperature is lower than 0°C degree or exceeds 55°C (131°F)	Change the water or contact local MSpa Service Center.
	Temperature sensor failure	
F1	Waterflow switch failure	Contact local MSpa Service Center.
	Filter failure	
	Water level is not at minimum water line	Add water above the minimum line.

PROBLEM	CAUSE	SOLUTION
NO DISPLAY ON THE WIRED CONTROLLER	Power failure	Check power supply
	PRCD is off	Reset PRCD by following PRCD Testing section
	PRCD broken	Contact local MSpa Service Center
	Press the Reset button, Control Panel is not displayed	Contact local MSpa Service Center

PROBLEM	CAUSE	SOLUTION
<b>NOT HEATING PROPERLY</b>	Temperature set too low	Set a higher temperature
	Dirty filter cartridge	Clean or replace the filter cartridge
	Water level is not at the minimum water line	Add more water to the minimum line
	Heater failure	Contact local MSpa Service Center
	Filter pump broken	Contact local MSpa Service Center
	Temperature protection switch trip off	Reset the heater
<b>NO BUBBLE</b>	Auto-off 10 minutes	Wait for 10 minutes
	Unidirectional threshold is not open	Contact local MSpa Service Center
	Control panel failure	Contact local MSpa Service Center
	Inflation knob is in <ON> position	Turn the knob to <OFF> position and turn on the bubble button again.
<b>FILTER PUMP DOES NOT WORK</b>	Filter stuck by dirt or other objects	Clean or replace the filter cartridge
	Filter system failure	Contact local MSpa Service Center
<b>SPA TUB IN AN ABNORMAL SHAPE</b>	Extra air pressure by strong sunlight	Check the air pressure and release some air if necessary. During hot weather, it is recommended to check if it is necessary to release some air to avoid any possible damage to the spa pool
<b>SPA LEAKING</b>	Spa inlet/outlet connection not securely tight	Tighten the inlet and outlet connection
	Drainage valve is not closed completely	Close the drainage valve. Contact the MSpa Service Center, if spa is still leaking
	Water leaks from the spa pool body	Repair the leaking hole/spilt with the repair kit material
<b>SPA LOSES AIR PRESSURE</b>	Air valve got loosen	Inflate the spa till the Yellow section of the manometer is pushed out. Make sure the valve is screwed tightly. Replace the valve if necessary.
	Hole or split on the spa tub	Put soap water in a squirt bottle and spray on seams. If there is a leak, small bubbles will come out. After you find the leak, clean and dry the leaking area, then use the repair patch comes with your spa to repair. Check the repair section on P15.
<b>WATER NOT CLEAN</b>	Water has been used too long	Change the water
	Insufficient filtering	Increase filtration frequency
	Dirty filter cartridge	Clean or replace the filter cartridge in time
	Improper water maintenance	Refer to the chemical manufacture's instruction

**CONTACT YOUR LOCAL MSPA DEALER OR SERVICE CENTER FOR ANY PRODUCT RELATED QUESTIONS OR PROBLEMS.**

Where can I find the serial number?

At the back of controller. Or at the foot of the control box.

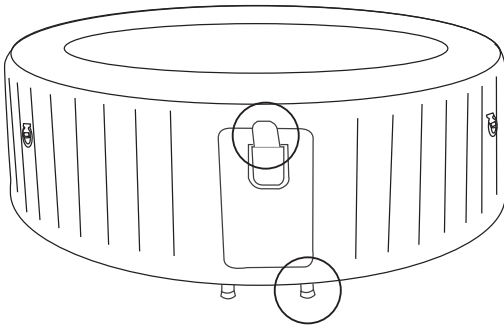

How can I find my service contact?

\* Scan the QR code below or visit <https://www.the-mspa.com/after-sales>.

1. Input the serial number of your spa.
2. The corresponding service provider will be displayed.



\* You can find the contact information of local service center on the back of the warranty card

## MSPA LIMITED WARRANTY

MSpa® has been manufactured with reliability and simplicity in mind. All products have been inspected and found free of defects prior to leaving the factory.

MSpa warrants this product against defects in material and workmanship for a period of: **ONE (1) Year**

The warranty period begins from the date of purchase and MSpa requires presentation of the original proof to purchase to ascertain the date. During the warranty period, MSpa will either repair or replace, at its discretion, any defective products. Replacement products or repaired parts will be warranted for only the unexpired portion of the original warranty.

### Shipping Policy

Consumers are responsible for the shipping/freight when return the defect parts to MSpa authorized service center or ORPC-Oriental Recreational Products (Shanghai) Co., Ltd.

### Warranty Policy

- This limited warranty does not apply to any defect resulting from negligence, accident, misuse, or other reason beyond MSpa's reasonable control, included but not limited to: normal wear and tear, negligence or failure to follow the product instructions, improper or inadequate maintenance; connection to improper power supply; chemical water damage, loss of pool water, unauthorized product modification or repair; use for commercial purpose; fire, lightning, flood or other external causes
- This warranty is valid only in the country of purchase in such countries where MSpa sells and services the same model with identical technical specifications
- Warranty service outside the country of purchase is limited to the terms and conditions of the corresponding warranty in the country of service. Where the cost of repairs or replacement is not covered by this warranty, MSpa will advise the owners and the cost shall be charged to the owner.
- This warranty only applies to the original purchaser and terminates upon any transfer of ownership.
- All repairs of which warranty claims are made must be pre-authorized by ORPC through an accredited distributor or agent provided that the defective part be returned to the distributor or agent Transportation Prepaid, if requested.
- All the authorized selling dealer is responsible for all in-field service work carried out on your MSpa product. ORPC will not be liable for results of cost of workmanship from unauthorized service person.
- Products marked with both MSpa and another producer are governed exclusively by the warranty provided by the other producer.

### Warranty Registration

Please always keep the purchase receipt, warranty card in case of future warranty inquiry. All claims must be submitted to MSpa authorized dealers or service partners. It is essential that all submitted claims provide all the necessary information, including Customer name, Purchase receipt, Serial No., Product No., Problem, and Parts requested.