

EN



AQUA MARINA

INFLATABLE  
STANDUP PADDLE BOARD  
**USER MANUAL**



## **WARNING**

For your own safety and that of your equipment, make sure to take the following precautions. Failure to follow warning notices and instruction may result in property damage, serious injury or death.

## **GENERAL PADDLING INFORMATION**

This manual has been compiled to help you operate your Inflatable Stand Up Paddle Board (Hereinafter referred to as ISUP) with safety and pleasure. It contains details of the ISUP, the equipment supplied, and information on their operation. Please read it carefully and familiarize yourself with the ISUP before using it.

## **SAFETY**

There is a risk of serious injury or death from drowning. Paddle sports can be very dangerous and physically demanding. The user of this product acknowledges, understands, and assumes the risks involved in paddle sports. Observe the following warning labels and safety standards carefully whenever using this product.



AM Official Site



AM HOW-TO Guide



AM Service Center List

# WARNING LABEL INSTRUCTIONS



## MANDATORY INSTRUCTION

- Wear personal flotation device
- Read instructions first
- Fully inflate all air chambers
- Numbers of users
- Max. load capacity
- Safe distance to shore 150 m (492.1')



## PROHIBITION INSTRUCTION

- Do not use in white water (except BT-22RP)
- Do not use in breaking waves (except BT-22WA)
- Do not use in offshore current
- Do not use in offshore wind
- Not for children 14 years old and below (except BT-22VIP)



## ATTENTION / DANGER / WARNING

- Design working pressure
- No protection against drowning



## MANDATORY INSTRUCTION

- Swimmers only

CN-ORP

**Item No.:**

Oriental Recreational Products (Shanghai) Co., Ltd.  
1699 Daye Road, Fengxian Shanghai, China 201402

## PRODUCT SERIAL NUMBER

- Item No.
- Manufacturer information

## ALL-AROUND

## TOURING

## RACING

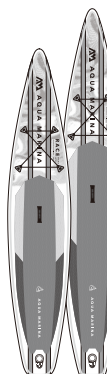
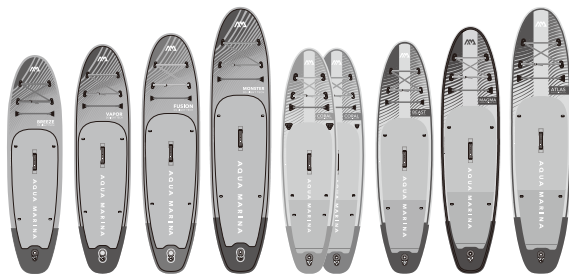

### MODEL

**BREEZE**    **VAPOR**    **FUSION**    **MONSTER**  
BT-23BRP    BT-23VAP    BT-23FUP    BT-23MOP

**CORAL**    **BEAST**    **MAGMA**    **ATLAS**  
BT-23COPR    BT-23BEP    BT-23MAP    BT-23ATP  
BT-23COPN

**CORAL TOURING**    **HYPER**    **HYPER**  
BT-23CTPR    BT-23HY01    BT-23HY02  
BT-23CTPN

**RACE**    **RACE**  
BT-21RA01    BT-21RA02

### SIZE

9'10"    10'4"    10'10"    12'0"  
30"    31"    32"    33"  
4.7"    6"    6"    6"

10'2"    10'6"    11'2"    12'0"  
31"    32"    33"    34"  
4.7"    6"    6"    6"

11'6"    11'6"    12'6"  
31"    31"    32"  
6"    6"    6"

12'6"    14'0"  
27"    27"  
6"    6"

300 cm    315 cm    330 cm    366 cm    310 cm    320 cm    340 cm    366 cm  
76 cm    79 cm    81 cm    84 cm    78 cm    81 cm    84 cm    86 cm  
12 cm    15 cm    15 cm    15 cm    12 cm    15 cm    15 cm    15 cm

350 cm    350 cm    381 cm    381 cm    427 cm  
79 cm    79 cm    81 cm    69 cm    69 cm  
15 cm    15 cm    15 cm    15 cm    15 cm

### FIN

1 SLIDE-IN CENTER FIN

1 SWIFT ATTACH CENTER FIN

1 SWIFT ATTACH RACING FIN

1 SLIDE-IN RACING FIN

### VOLUME

229 L    315L    338L    390L

238L    312L    340L    398L

328L    330L    370L

320L    360L

### MAX. RIDER WGT

220 LBS    308LBS    330LBS    374LBS  
100 KG    140KG    150KG    170KG

231LBS    308LBS    330LBS    396LBS  
105KG    140KG    150KG    180KG

286LBS    330LBS    374LBS  
130KG    150KG    170KG

330LBS    352LBS  
150KG    160KG

### MAX. AIR PRESSURE

15 PSI

15 PSI







15 PSI

15 PSI

15 PSI /  
10 PSI  
(center chamber)

18 PSI

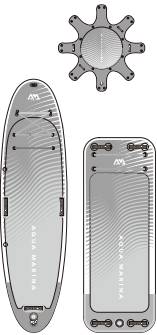

	RIVER	SURF	WINDSURF	MULTI-PERSON				FITNESS		FISHING	KID
											
<b>RACE ELITE</b> BT-22RE	<b>RAPID</b> BT-22RP	<b>WAVE</b> BT-22WA	<b>BLADE</b> BT-22BL	<b>SUPER TRIP</b> BT-21ST01	<b>SUPER TRIP TANDEM</b> BT-20ST02	<b>MEGA</b> BT-20ME	<b>AIRSHIP RACE</b> BT-20AS	<b>DHYANA</b> BT-23DHP	<b>PEACE</b> BT-23PC	<b>DRIFT</b> BT-20DRP	<b>VIBRANT</b> BT-22VIP
14'0" 25" 6"	9'6" 33" 6"	8'8" 30" 4"	10'6" 33" 6"	12'2" 32" 6"	14'0" 34" 6"	18'1" 60" 8"	22'0" 34" 8"	10'8" 34" 6"	8'2" 35" 6"	10'10" 38" 6"	8'0" 28" 4"
427 cm 63.5 cm 15 cm	289 cm 84 cm 15 cm	265 cm 75 cm 10 cm	320 cm 84 cm 15 cm	370 cm 82 cm 15 cm	427 cm 86 cm 15 cm	550 cm 152 cm 20 cm	670 cm 87 cm 20 cm	325 cm 86.5 cm 15 cm	250 cm 90 cm 15 cm	330 cm 97 cm 15 cm	244 cm 71 cm 10 cm
<b>1 FIBERGLASS RACING FIN</b>	<b>1 RIVER FIN + 4 FIXED FINS</b>	<b>1 SURF CENTER FIN + 2 SIDE FINS</b>	<b>1 CENTER FIN + 1 DAGGER FIN</b>	<b>1 CENTER FIN</b>	<b>2 CENTER FINS</b>	<b>5 CENTER FINS</b>	<b>1 RACING FIN</b>	<b>1 SWIFT ATTACH / CENTER FIN</b>		<b>1 CENTER FIN</b>	<b>1 CENTER FIN</b>
330L	300L	161L	350L	400L	500L	1400L	1000L	347L	340L	284L	140L
330LBS 150KG	286LBS 130KG	209LBS 95KG	330LBS 150KG	462LBS 210KG	507LBS 230KG	1433LBS 650KG	1014LBS 460KG	341LBS 155KG	330LBS 150KG	286LBS 130KG	132LBS 60KG
18 PSI	18 PSI	18 PSI	18 PSI	15 PSI	18 PSI	8 PSI	18 PSI	15 PSI		15 PSI (board) / 3PSI (side air chambers)	15 PSI

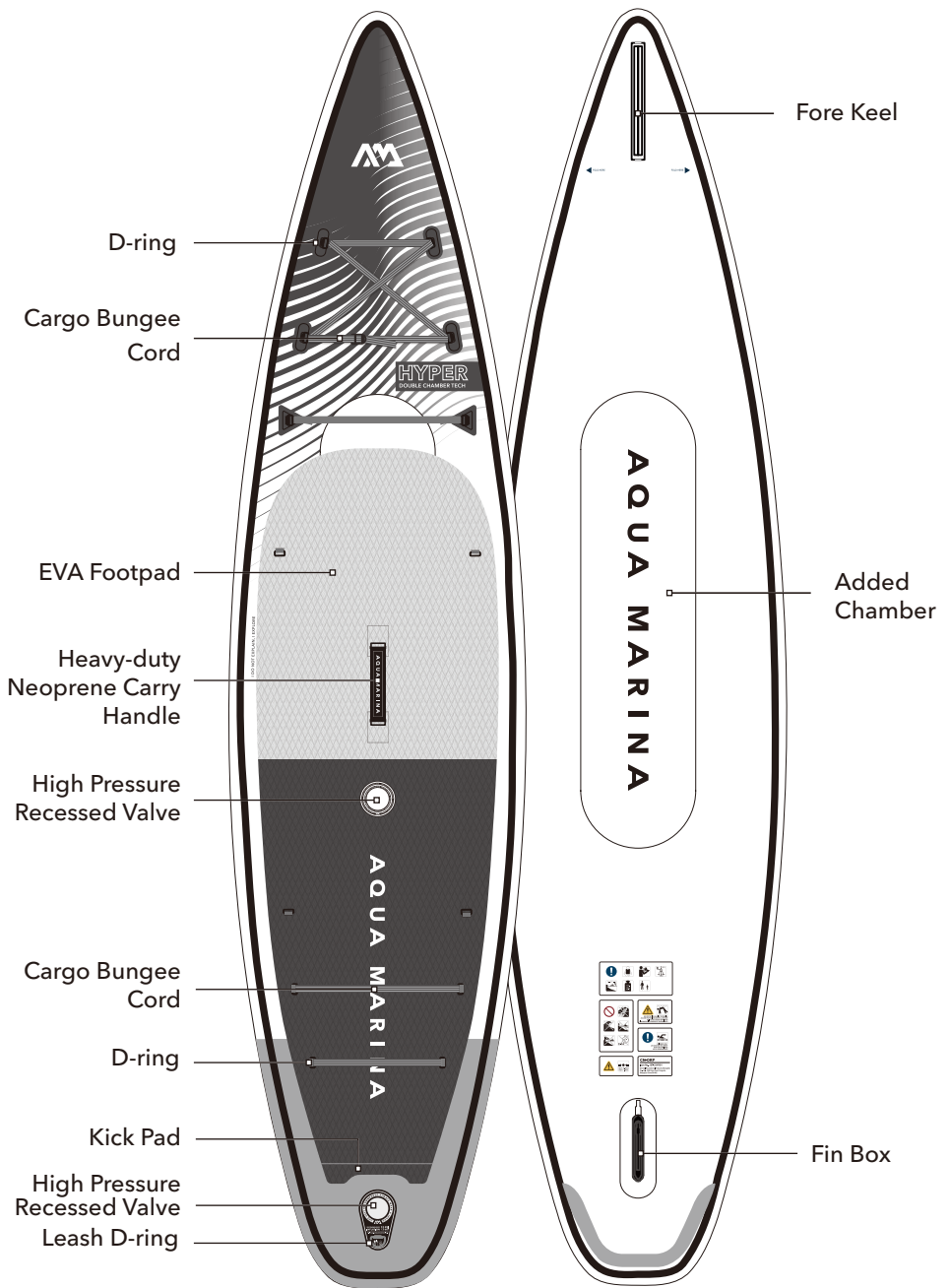

**Actual configuration may vary upon different models.**

# ACCESSORIES

## STANDARD

Zip Backpack



Double-action Pump  
(Mega/Airship Race/ Super Trip Tandem x 2)



Fin  
(Mega x 5/  
Super Trip Tandem x 2/  
Wave x 3/ Blade x 2)



Cargo Bungee Cord  
(except Wave)



Leash  
(except Super Trip/ Super Trip Tandem/Mega/  
Airship Race/Peace/Yoga Dock)

Repair Kit



\*Actual configuration may vary upon different models.

## DRIFT

Fishing Rod Holder x 2

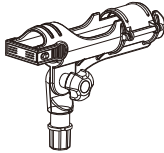

Paddle Holder

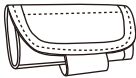

## MEGA/YOGA DOCK

Carry Bag



## CORAL/CORAL TOURING/YOGA

2-in-1 Carry Strap



Paddle Holder  
(Only for Dhyana)

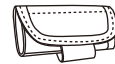

Straps x 3  
(Only for Dhyana)

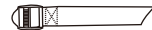

## PADDLE

Paddle (excluded from Race/Race Elite/Hyper/Rapid/Super Trip/Mega/  
Airship Race/Blade/Wave/Peace/Super Trip Tandem)

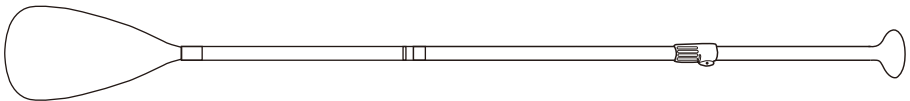

# INSTRUCTION FOR ASSEMBLING AND DISASSEMBLING

## INFLATION

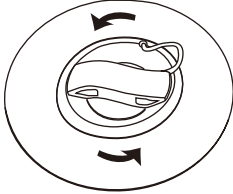

Open the valve cap by twisting counter-clockwise. Ensure the valve is clear from debris, sand, or dirt before releasing.

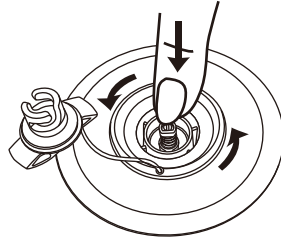

Push valve button in and turn 90 degrees.

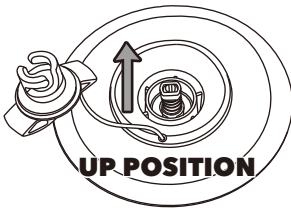

OR

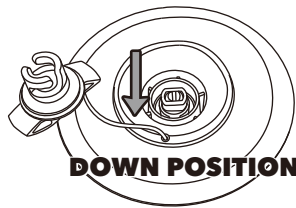

Valve button popping up to the "UP position" for inflation.

Valve button locked in "DOWN position" for deflation.

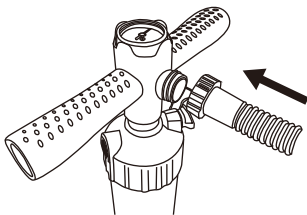

**Attach** - Attach the pump hose to the pump and secure it tightly.

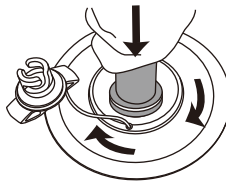

**Connect** - Attach the end of the pump hose to the valve and twist 45° clockwise to lock in place.

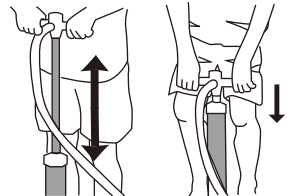

**Save Effort** - As pressure builds, keep arms extended and bend the knees to power for less effort.

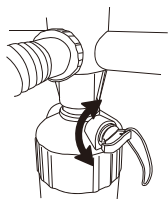

### LIQUID AIR V1

**Fast Inflation** - Use **DOUBLE ACTION** position by closing the air-tap to pump the board up to 7-10 psi.

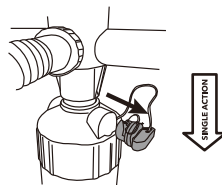
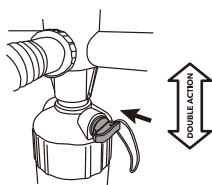

**Easy Inflation** - Switch to **SINGLE ACTION** position by removing the air-tap for easier inflation.

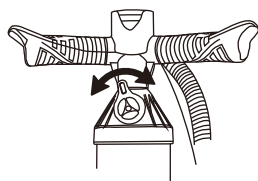

### LIQUID AIR V2

**Fast Inflation** - Use **DOUBLE ACTION** mode with the top cap displaying "2" to pump the board up to 7 - 10 psi.

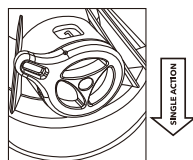
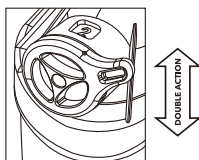

**Easy Inflation** - Rotate the switch to **SINGLE ACTION** mode with the top cap displaying "1" for easier inflation.

**Note:** Gauge will not respond until reaching 4psi. Just keep pumping for 2-3 minutes!

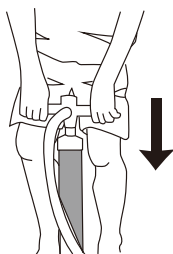

**Max. Pressure** - Keep pumping the board until you reach 15-18 psi.



**12PSI minimum (8PSI for MEGA/ 10PSI for HYPER inner chamber) for proper inflatable boards operation and 15PSI maximum (18PSI for SUPER TRIP TANDEM/ RAPID/ RACE/ RACE ELITE/ WAVE/ BLADE/ AIRSHIP RACE ). Over inflation will void your warranty.**

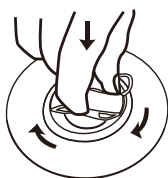

**After inflation, return the valve cover and tighten in clockwise direction to lock in place.**

## Warning:

Do not leave your board under direct sunlight as this may cause over-inflation.

Please keep the board under shade when not in use with a working pressure NO MORE THAN 10psi, or leave your board in a cool dry place.

Remember to check the air pressure before and after use, and deflate your board when necessary.

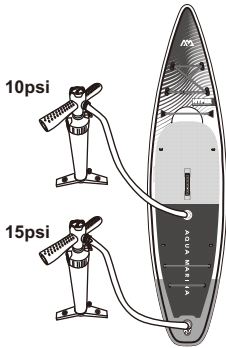

## For Double Chamber Board ( HYPER )

For best performance, the double chamber should always be inflated to ensure the highest stiffness and safety.

- Inflate the inner chamber up to 10 PSI.
- Inflate the outer chamber up to 15 PSI.

## PRECAUTION & TIPS

- Electric Pumps can be used to inflate board up to 80-90%. However, the remaining pressure required should be achieved by using the hand pump to avoid over-inflation.
- Do not use air compressors as this voids warranty of board.
- Before long trips, ensure the board has been inflated and has maintained pressure for a minimum of 24 hours.

## FIN INSTALLATION

### Slide-in Center Fin System

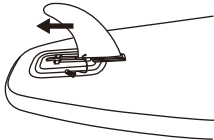

**SLIDE** - Slide in the large Center Fin to the fin base.

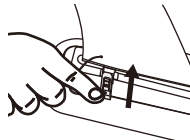

**INSERT** - Insert the push-in pin.

## Swift Attach Fin System

( CORAL / BEAST / MAGMA / ATLAS / CORAL TOURING / HYPER / WAVE / DHYANA )

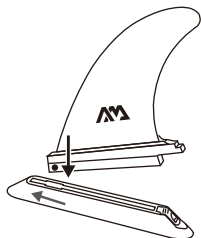

**SLOT IN** - Align the fin base into the fin box slot and slide to the front edge.

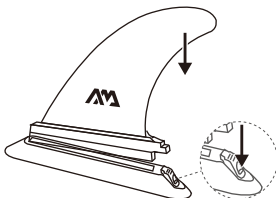

**PRESS** - Keep pressing the lever on the rear and push the fin down.

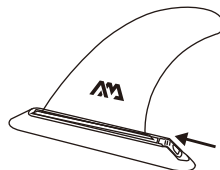

**SNAP** - Lock the fin in place with the snap.

---

**NOTE:** Install the WAVE side fins as suggested below.

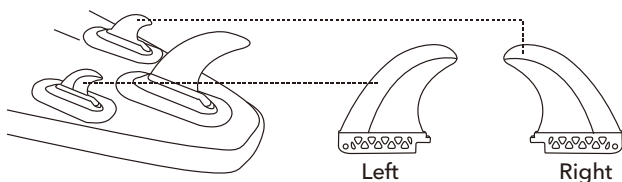

---

## US Fin System ( RACE ELITE )

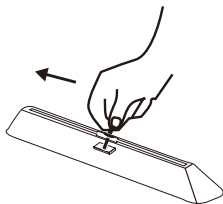

**WASHER** - Place the washer into the fin box and slide it to the front.

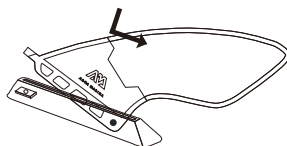

**SLOT IN** - Align the fin base into the fin slot and slide to the rear of the fin box.

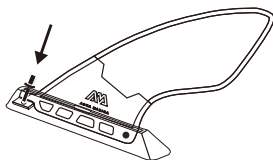

**LINE UP** - Push the fin down and line up the washer hole with the screw.

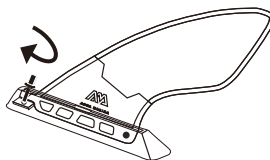

**SCREW** - Secure firmly by screwing.

# DEFLATION

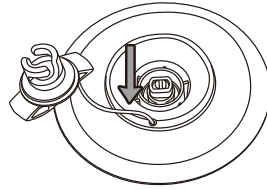
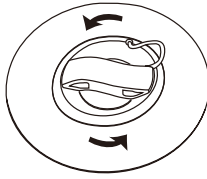

**Valve Open** - Open the valve cap and twist the valve button for "DOWN POSITION". Ensure the valve is clear from debris, sand, or dirt before releasing.



**Deflate (by hands)** - Roll the board from nose to tail to squeeze the air out.

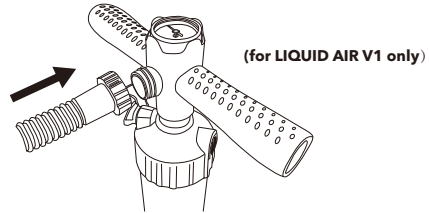

**Deflate (by pump)** - Use the pump on "DEFLATE" position.

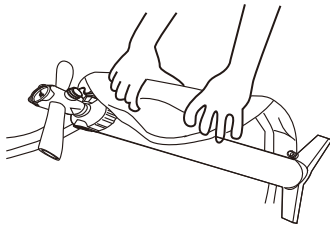

**Roll** - Roll the board around the pump. Make sure the pump is settled in the middle.

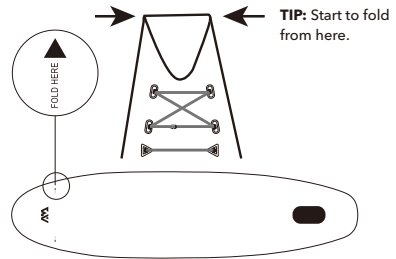

or

**Roll** - Follow the folding line indication for first fold, and roll the board from nose to tail.

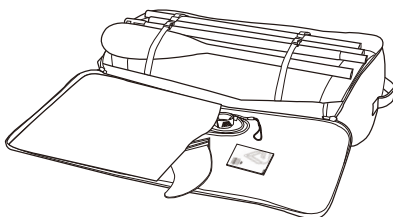

**Pack** - Use the webbing strap to secure the neatly rolled board in place, but do not overtighten the strap. Place the accessories in the pocket.



# YOGA DOCK INSTRUCTION

## YOGA DOCK and DHYANA Connection

Each DHYANA yoga board can be connected to this YOGA DOCK by three straps.

For each strap, follow connection instruction shown below.

1. Link up the clasp (a) with D-ring (b) on the board. Thread the strap through D-ring (c) on the dock.
2. Thread the strap through the buckle (d) and fasten.
3. Repeat above steps for the rest straps.

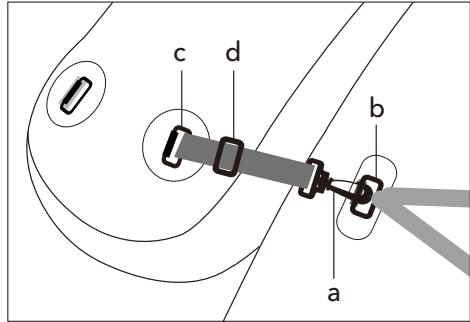

## Folding and Storage

1. Fold the Yoga Dock as shown below.
2. Pack the Yoga Dock into the carry bag.

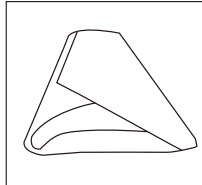
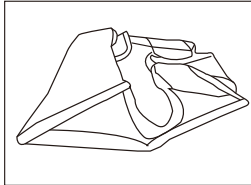
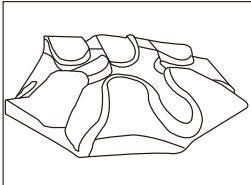

# PADDLE ASSEMBLY

1



Correct



Incorrect

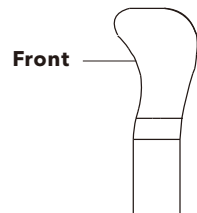

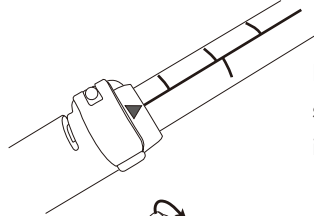
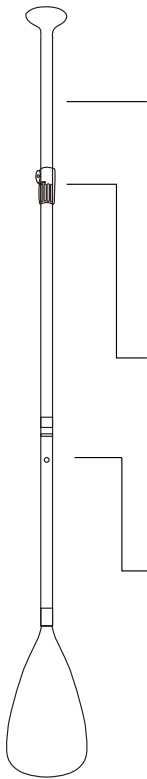

Ensure the center line of the scale is aligned with the indicator on clamp.

**CLAMP SYSTEM**

Adjust tightness by rotating the hasp to reduce any play.

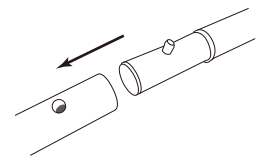

**SPRING PIN SYSTEM**

Secure spring pin.

**NOTE: Always drain the water left in the paddle shaft after each use.**

**3 PCS ADJUSTABLE**

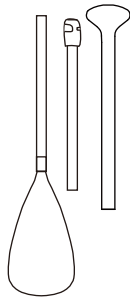

- **ACE** B0303622  
Adjustable Aluminum iSUP Paddle for Kids
- **SPORTS III** B0303922  
Adjustable Aluminum iSUP Paddle
- **PASTEL** B0303923/24/25  
Fiberglass / Carbon iSUP Paddle
- **SOLID** B0303013  
Fiberglass iSUP Paddle
- **CARBON GUIDE** B0303014  
Carbon / Fiberglass iSUP Paddle
- **CARBON PRO** B0303015  
Carbon iSUP Paddle

**2 PCS ADJUSTABLE**

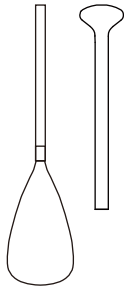

- **CARBON X**  
B0303016  
2PCS Carbon iSUP Paddle

**2-IN-1**

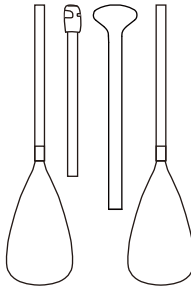

- **DUAL-TECH**  
B0303011  
2-in-1 iSUP & Kayak Paddle

# HOW TO WEAR A SAFETY LEASH

## WAIST



RIVER LEASH  
B0303025

## ANKLE



COIL LEASH  
B0303930



SURF LEASH  
B0303024



STANDARD LEASH  
B0303929

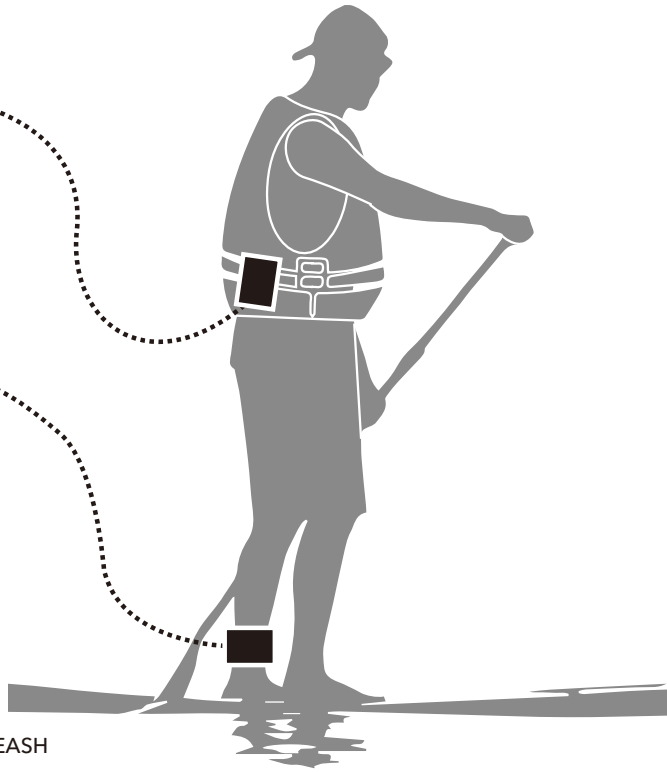

### STANDARD LEASH INSTALLATION

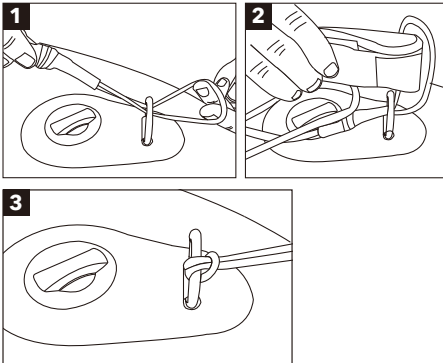

### COIL/SURF/RIVER LEASH INSTALLATION

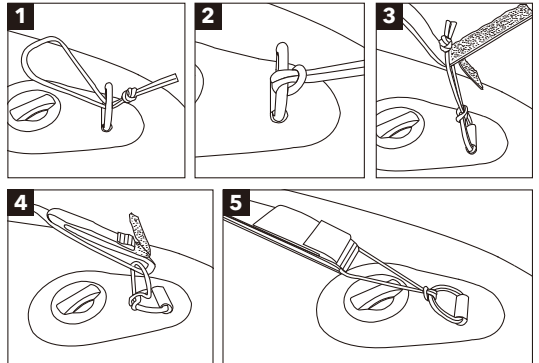

# HOW TO TAKE CARE OF ISUP BOARD

## DO'S

### CLEANING

Clean the board after each use with freshwater and mild soap.



### KEEP IT DRY

Dry the board after each use, especially before storing to avoid mould damage.



### FREQUENT USE

Use the board frequently as long-term storage may cause adhesive failure.



### REGULAR MAINTENANCE

Regularly check for cracks, scrapes, or any other issues and repair if necessary.



## DON'TS

### DON'T USE AN AIR COMPRESSOR

You can easily over-inflate the board by using an air compressor and void the warranty.



### NO DRAGGING

Don't drag the board as sharp debris may puncture it.



### AVOID DIRECT SUNLIGHT

Keep the board under shade when not in use with a working pressure less than 50%-60% of the max. air pressure.



### AVOID TEMPERATURE EXTREMES

Keep the boards sheltered away from temperature extremes and humidity. Store at room temperature between 0°C - 40°C.



## FAQs (Frequently Asked Questions)

**Q: How much air should I pump into my board, and how long does it take to inflate?**

A: The maximum pressure is 15 - 18 PSI (8 PSI for MEGA, 10 PSI for HYPER inner chamber, 3 PSI for DRIFT side chambers), any higher you risk over inflating and damage. Depending on the size of your board it can take anywhere from 5 to 8 minutes.

**Q: When detaching the pump from the board, the air starts to release from the valve. How do I stop this from happening?**

A: The air is releasing as the valve spring pin has been left in the deflating position. Simply push down and turn the pin until it lifts up into the inflation position and stops air from releasing; continue to inflate the board until up to pressure.

# HOW TO REPAIR A CUT OR PUNCTURE IN YOUR INFLATABLE BOARD

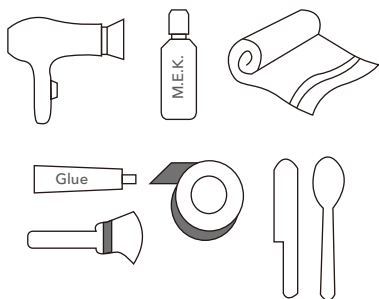

## SUPPLIES REQUIRED

- Glue (AQUASEAL® is recommended)
- Acetone or methyl ethyl ketone (M.E.K.)
- Hairdryer
- Brush
- Tape
- Spatula or spoon
- Towel

(Not provided in the SUP board package)



1

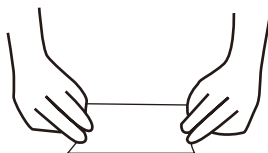

2

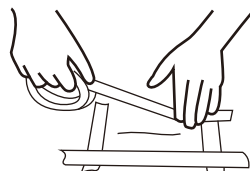

3

1. Clean the area around the cut or puncture using acetone or M.E.K.
2. Draw the outline of the patch using chalk or pencil (do not use ink).  
Cut the patch, cover the cut or puncture with approximately 2.5cm (1 inch) overlap on all sides.
3. Apply tape along the outline of the patch. This will prevent the glue from spreading outside the patch area.

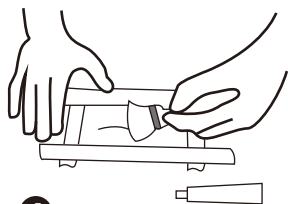

4

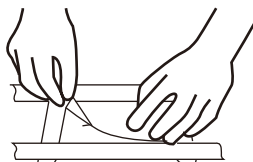

5

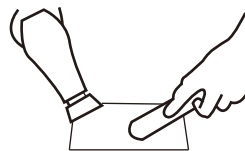

6

4. Apply glue on both the board and patch using a brush or other applicator. Make sure the glue is spread evenly and completely over the board and patch. Let the glue dry for 5 minutes.

5. Apply the patch starting on one side and move towards the other side  
Be careful not to trap any air bubbles.
6. Use a hairdryer to gently heat the area to ensure a good bond between the patch and the board.

Use a metal spatula or spoon and firm pressure to ensure a good bond and to remove any air bubbles.

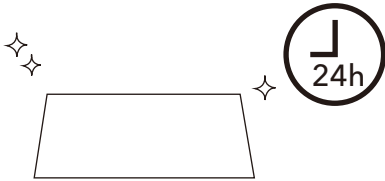

**Allow the glue to cure with the board un-inflated for 24 hours prior to use.**

## HOW TO FIX A LEAKING VALVE

### A. Try to tighten the valve

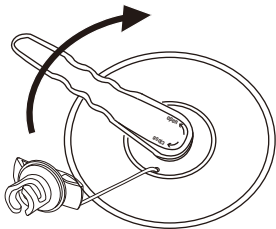

1. Inflate your board up to the max air pressure
2. Stick your valve wrench down inside of valve and turn clockwise to tighten the valve back down onto the board

### B. Re-install or replace a valve

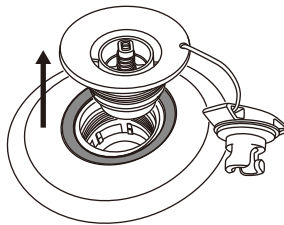
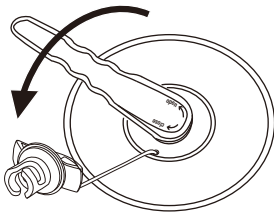

1. Completely deflate your board
2. Undo the dust cap and insert the valve wrench into the valve and twist counterclockwise to remove the valve

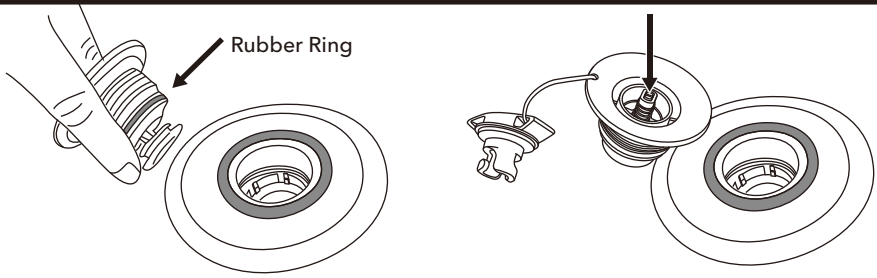

3. Check the rubber ring to make sure that it is in the correct position, tight around the valve and there is no debris in the way
4. Be sure the pin spring is functioning properly and that there are no cracks along the edges

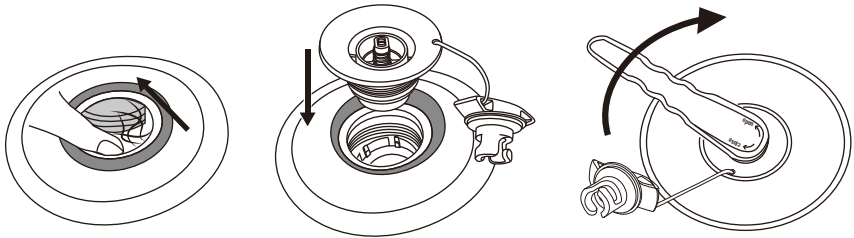

5. Ensure there are no strings from the drop stitching material
6. Note the bottom piece of the valve is not attached to anything
7. Fit the valve back into your board
8. Align all the threads and twist to tighten
9. Once the valve is hand tight, use the valve wrench to seal completely



**NOTE: Correctly use the wrench by pressing it with one hand on top.**

# WARRANTY

**2  
YEAR**

AM warrants this product to be free from major defects in material or workmanship to the original purchaser for a period of **2-year** (board ONLY) from the date of purchase. This warranty is subject to the following limitations.

1. The warranty is valid only when this product is used for normal recreational activities and does not cover products used in rental or school operations.
2. AM will make the final warranty determination, which may require inspection and/or photos of the equipment, which clearly show the defect(s). If necessary, this information must be sent to the AM distributor in your country with prepaid postage. Product can be returned only if a return authorization number is given in advance by the AM distributor. The return authorization number must be clearly labelled on the outside of the package, or it will be refused.
3. If a product is deemed to be defective by AM, the warranty covers the repair or replacement of the defective product only. AM will not be responsible for any costs, losses, or damages incurred as a result of loss or misuse of this product.
4. This warranty does not cover damage caused by misuse, abuse, neglect, normal wear and tear including, but not limited to punctures, damage due to excessive heat exposure, damage caused by improper handling and storage, damage caused by use in waves or shore break, board breakage caused by filling or crashing in surf conditions, or damage caused by anything other than defects in material and workmanship.
5. This product must not be modified and/or fitted with a motor except AM BlueDrive power fin.
6. This product must not be used in excess of the manufacturers recommended maximum load capacity.
7. This warranty is void if any unauthorized repair, change or modification has been made to any part of the equipment.
8. The warranty for any repaired or replacement equipment is good from the date of the original purchase only.
9. The original purchase receipt must accompany all warranty claims. The name of the retailer and date of purchase must be clear and legible.
10. There are no warranties that extend beyond the warranty specified here in.



**WARNING**

**This product is designed in accordance with standards for a specific use. Any modifications or transformations higher than that indicated by the manufacturer could result in serious risks for the user and will void the warranty.**