

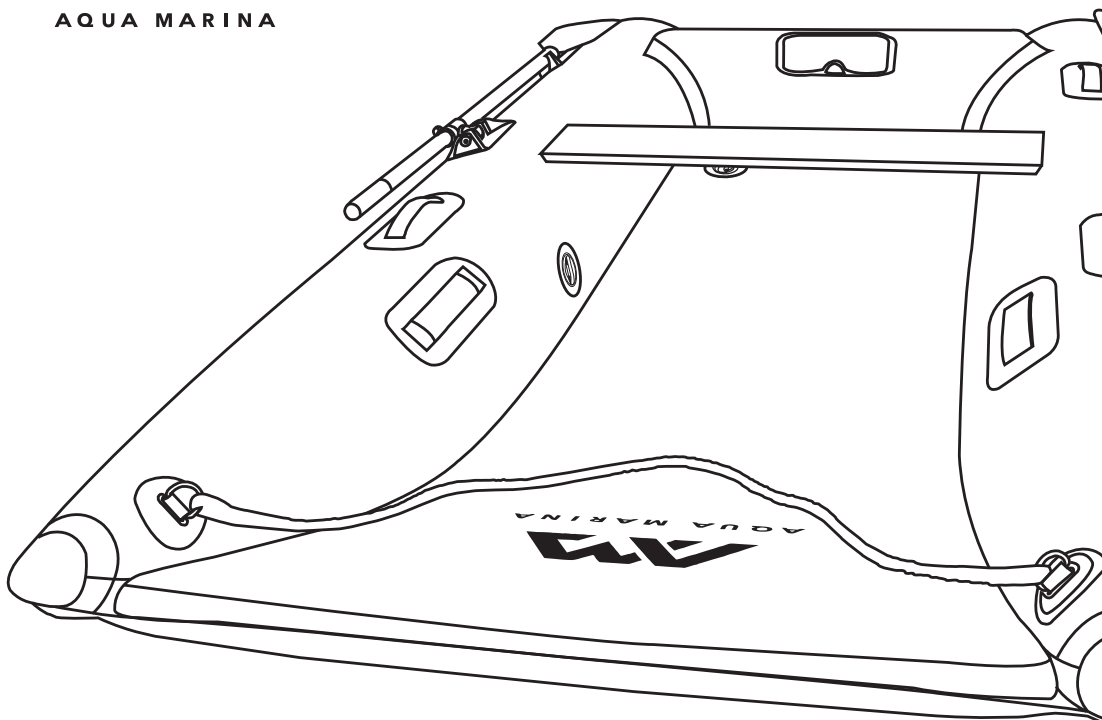

AQUA MARINA



INFLATABLE AIR-DECK CATAMARANS

User's Guide

BT-AC285 / BT-AC335



www.aquamarina.com

THANK YOU FOR CHOOSING AQUA MARINA AIRCAT CATAMARANS

Compact and lightweight, these economical inflatable catamarans are ideal water safety crafts for touring, take-away camping and family weekend outing. Featuring ultra-stable tunnel hull and generous deck space, this inflatable catamaran is impressive with its outstanding capacity and the ability to brave winds and waves while being high-speed. Gone are the days when a dedicated boat trailer is required. Now just pack it in the carry bag, together with all the matching accessories, it can fit into the back seat of most cars.

This manual has been compiled to help you achieve long term safe use and pleasure from your Aqua Marina® boats.

GENERAL INFORMATION

SAFETY

In a manual of this type it is impossible to give adequate space to the topic of water safety. Check in your local area for information and/or training as needed. Inform yourself about local regulations and dangers related to boating and/or other water activities. It is your responsibility to be aware of and comply with all relevant safety regulations. For all water recreation or sport you should have a reasonable swimming ability. Just as swimmers have a cardinal rule about not swimming alone. It is strongly advised that you should never go boating alone.

PLEASE KEEP THIS MANUAL IN A SECURE PLACE, AND HAND IT OVER TO THE NEW OWNER WHEN YOU SELL THE CRAFT. RECORD THE "HULL IDENTIFICATION NUMBER" (HIN) WHICH IS LABELLED ON THE BOAT

S/N.....

MANUFACTURER'S CERTIFICATION

Our boats comply with the ISO 6185 standard established by the International Organization for Standardization.

MANUFACTURER'S RECOMMENDATION

The total number of persons, motor power and total weight shall not exceed the limits labeled (Fig. 1) on the boat.

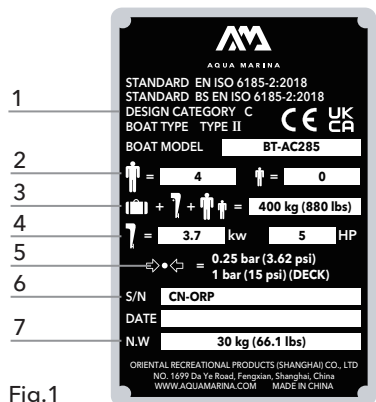

Fig.1

Label format for boat

1. As per Directive 2013/53/EU & Recreational Craft Regulations 2017 boat design category Design Category C - Inshore:
Designed for voyages in coastal waters, large bays, estuaries, lakes and rivers where conditions up to, and including, wind force 6 and significant wave heights up to, and including, 2m may be experienced.
2. Maximum person's capacity without console
3. Manufacturer's recommended maximum load capacity
4. Maximum motor power
5. Manufacturer's recommended working pressure
6. Hull identification number (HIN)
7. Net weight

SAFETY CHECK LIST & SAFETY WARNING

- Always wear an approved Personal Flotation Device (Life Preserver).
- Be aware of your local boating rules and regulations and abide by them accordingly.
- Check inflation levels each time before you go out and inflate your boat for a full 24 hours before undertaking long trips.
- DO NOT allow children to use Aqua Marina unsupervised.
- DO NOT consume alcohol while boating or operating a boat while under the influence of alcohol or drugs.
- DO NOT drag your Aqua Marina over rocks or gravel if it can be avoided.
- DO NOT exceed the certified maximum capacities of this boat under any circumstance.
- DO NOT go boating alone.
- DO NOT use compressors, co² or compressed air for inflation, only use Aqua Marina recommended pumps.
- DO NOT use your Aqua Marina Boat as a personal flotation device as they are designed for leisure/recreation in mind.
- DO NOT sleep inside of your Aqua Marina while on the water.

INFLATABLE BOAT SPECS & FEATURES

SPECIFICATIONS

Model	Category	Item size	Max. Air pressure	No. of air chamber	Max. Passenger	Max. Payload	Max. Motor Power	Net weight
BT-AC285	C	9'4"x63" (2.85x1.6m)	0.25bar/3.62psi Hull 1bar/15psi Floor	2+1+2	4	400 kg (880lbs)	5HP/ 3.7KW	30 kg (66.1 lbs)
BT-AC335	C	11'0"x63" (3.35x1.6m)	0.25bar/3.62psi Hull 1bar/15psi Floor	2+1+2	5	500 kg (1100lbs)	9.9HP/ 7.5KW	33.5 kg (73.9 lbs)

PART LIST

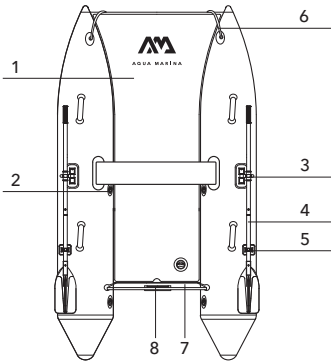

BT-AC285

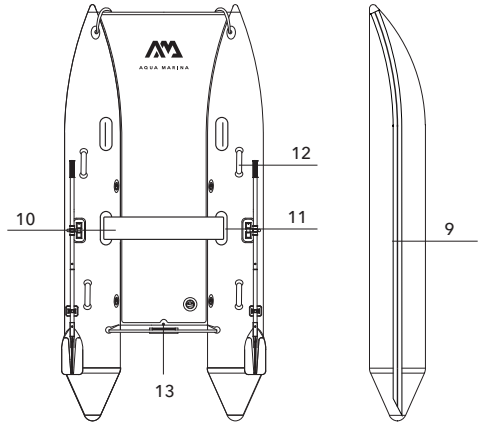

BT-AC335



14



15



16



17

1	DWF air deck floor	10	Wooden bench seat
2	High pressure recessed valve	11	Seat connector
3	Rotation oarlock	12	Safety grab handle
4	Aluminum oar	13	Drain valve
5	Oar holder	14	Carry bag
6	Towing rope	15	Double-action pump with gauge, Inflation hose
7	Transom (Height 15"/38.1cm)	16	Repair patch
8	Engine mount	17	Wrench
9	Anti-collision rubber strake		

NOTE: Drawings and pictures for illustration purpose only. Actual product may vary. Not to scale.

INSTRUCTION FOR ASSEMBLING AND DISASSEMBLING

A

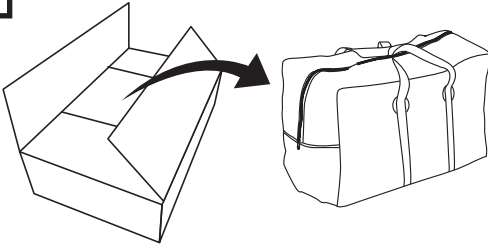

UNFOLD THE BOAT

Clear a clean and flat space that is free of any sharp objects and unroll the boat hull so that it is laid out flat.

B

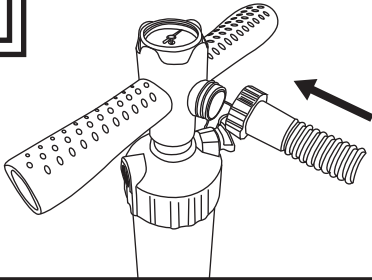

Pump Set Up And Inflation

Connect the pump hose to the gauge housing and secure it tightly.

C

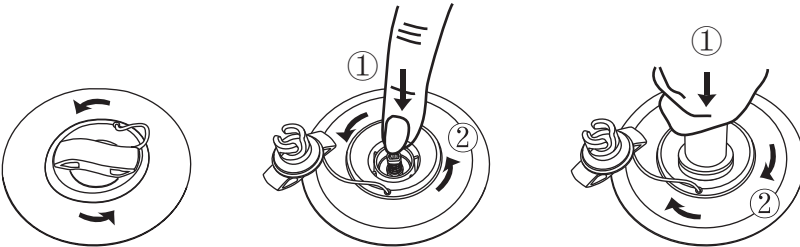

1. Open the valve cap by twisting counter-clockwise. Ensure the valve is clear from debris, sand, or dirt before releasing.
2. Push valve button in and turn counter-clockwise 90 degrees so it pops up and is in the "OUT" position.
3. Insert the pump hose and twist it 45 degree clockwise to lock in place. Inflate until you reach the required pressure.

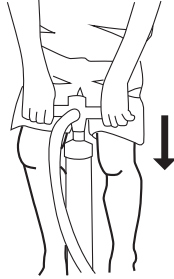
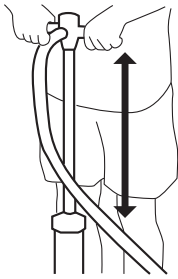

Inflate Faster With Less Effort

- Use full range of the pump cylinder while keeping your arms extended.
- Bend your knees and use the body weight.

D

LIQUID AIR V1

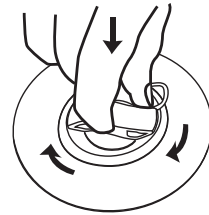
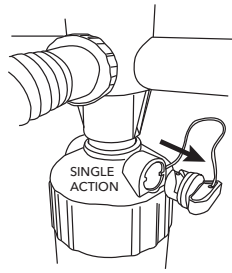
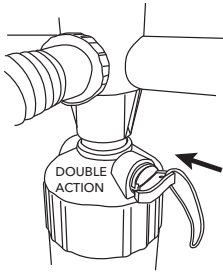

The pump can be switched between double action mode and single action mode.

1. Use **DOUBLE ACTION** mode by closing the air-tap to pump the boat hull up to 0.25 bar/ 3.62 psi, and the deck floor up to 0.5 bar/ 7 psi.
2. Switch to **SINGLE ACTION** position by opening the air-tap to pump the deck floor up to 1 bar/ 15 psi.



Over inflation will void your warranty. 12PSI minimum for proper inflatable deck floor operation and 15PSI maximum.

PRECAUTION & TIPS

- Electric Pumps can be used to inflate boat up to 80-90%. However, the remaining pressure required should be achieved by using the hand pump to avoid over-inflation.
- Do not use air compressors as this voids warranty of boat.
- Before long trips, ensure the boat has been inflated and has maintained pressure for a minimum of 24 hours.

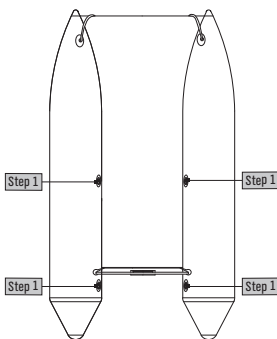
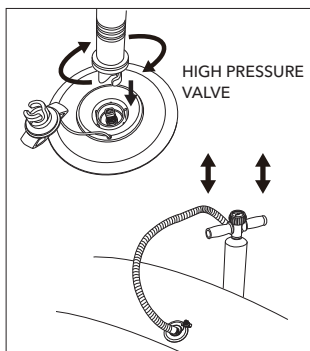
E

(1)



(2)

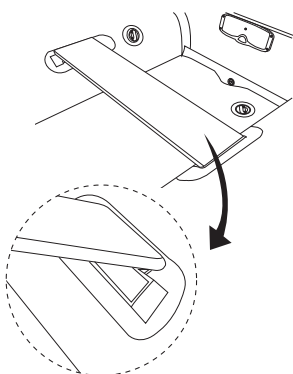

(3)

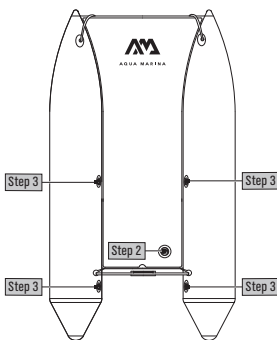

(4)

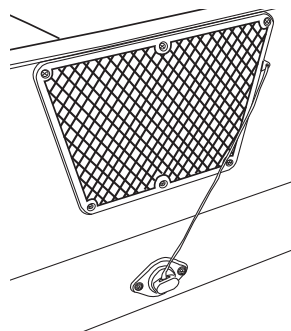

(5)

INFLATE THE BOAT

1. Inflate the tube chambers until the surface is free of wrinkles. By partially inflating the boat, the floor and the bench seat will be easier to install.
2. Place the DWF air deck floor inside of the boat with the air valve facing up.
3. Start to install the wooden bench seat. Slide the bench seat into the position by inserting the flaps on both chambers of the boat into notches on the seat board. Please note the second bench seat is sold separately.
4. With the floor installed and the seat in place, you are now ready to fully inflate the floor up to the maximum air pressure (1 bar/ 15 psi). Then, fully inflate the tube chambers up to the maximum air pressure (0.25 bar/ 3.62 psi).

5. Insert the plug into the drain valve beneath the transom.

IMPORTANT!

Make sure that the drain valve is always in the closed position as shown in picture (5) while on the water. When you are motoring is the only time that the drain valve can be in the opened position.

NOTES: Always check the inflation pressure before using the boat. Air temperature and weather conditions do affect the internal air pressure of inflatable products. In cold weather the product will lose some pressure due to the fact that the air will contract. If this occurs, you may want to add a little air to the product. However, in hot weather, the air will expand. In this case, you must let some air out to protect the product from overpressure.

- Only use Aqua Marina® approved inflation pumps.
- Under and over-inflation will result in safety hazards.
- Never stand on or rest objects on the boat during inflation.
- Never open the cap of air valve while the boat is in use.
- Be sure the valve is tightly closed before using the boat.

F

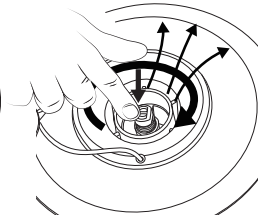
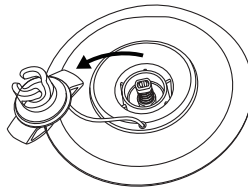
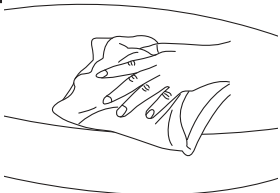

HIGH PRESSURE VALVE

BOAT DEFLATION

Before deflation, please keep in mind that you should not fully deflate one chamber while other chambers remain fully inflated as this can cause damage to the bulkheads of your boat.

1. Clear any water or debris out of the valve areas.
2. HIGH PRESSURE VALVE

Open the valve cap first. Slowly press down on the valve stem to start letting air out of the boat. There will be an initial burst of air, but that will slow down very quickly. Once the air flow has slowed down, press the valve stem all the way down and turn it clockwise to lock it into the **“OPEN”** position.

3. Open all air valves including the ones on the tube chambers and the DWF air deck floor. Release around 50-75% of the air from each chamber before fully deflating. Excess air can be pushed out as you roll up the boat.

NOTE: Remember to remove the DWF air deck floor before folding.

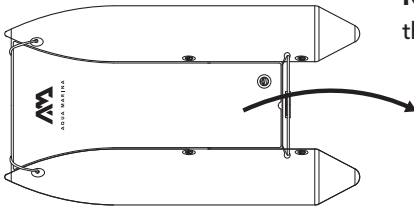

(1)

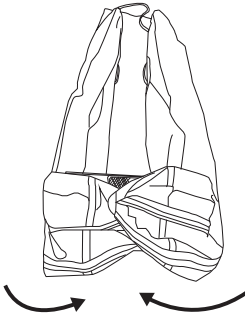
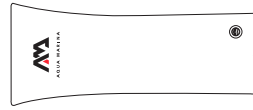

(2)

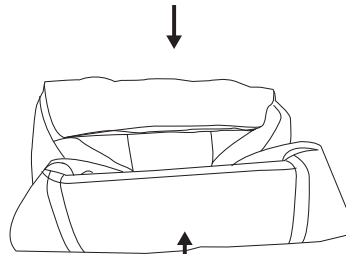

(3)

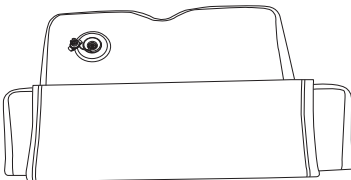

(4)



(5)

BOAT FOLDING STEPS

1. Remove all the accessories from the boat: oars, wooden seat and the DWF air deck floor.

NOTE: Remember to remove the DWF air deck floor before folding.

2. Fold the end of the tube chambers towards the transom.
3. Roll the boat towards the bow, pushing out any remaining air as you go. Then have one fold from the bow and tuck the bow neatly underneath.
4. For the DWF air deck floor, make the first fold from the front. Continue folding towards the valves tightly, pushing out any remaining air as you go.
5. The boat storage bag is designed to allow you to get your boat into the bag as easily as possible with minimal folds.

ACCESSORY ASSEMBLY

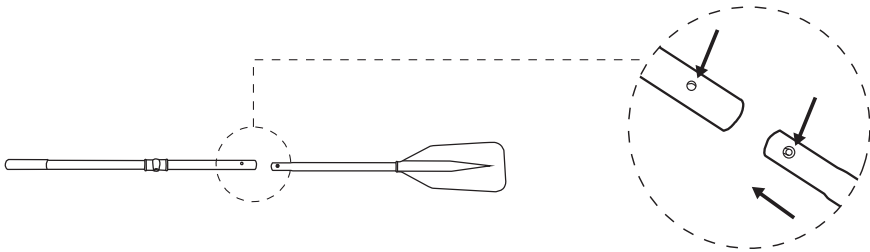

(1)



(2)

1. OAR ASSEMBLY

- 1) Join the two shafts of the oars by snapping them together.
- 2) There are pre-drilled holes in the middle of the oars so you can slide it over the oar holder and then secure the oar in place by using the rotation oarlock.

NOTE: When the oars are not in use, leave the oars in the oar holders to avoid damage and loss.

2. OUTBOARD MOTOR INSTALLATION

After the boat is fully inflated and well assembled, attach your outboard motor onto the Engine Mount at the center of the transom.

NOTE:

- Ensure the motor is always fixed on the transom.
- Read the instruction manual of the outboard motor for correct installation and operation.

WARNING:

Overpowering a boat can result in serious injury, death or boat damage. Do not exceed the maximum motor power.

PRODUCT CARE AND STORAGE

The boat is made of the high quality materials and complies with ISO 6185 standards. Altering the construction of the boat will endanger your own safety, safety of the occupants and void the limited warranty!

There is very little that you have to do to keep your boat in good condition for many years.

- When landing on the shore, carry the boat. Do not tow it on the sand or ground as damage may occur.
- If you use the towing D-ring to tow the boat, go slowly to avoid over-towing as damage may occur.
- Clean your boat after a trip to prevent damage from sand, salt water or sun exposure. Most dirt can be removed with a garden hose, a sponge and mild soap.
- Make sure the boat is completely dry before storing, and remove any excess moisture that could cause unsightly mildew. Use as few cleaning agents as possible, do not discharge waste agents into water, and clean your boat preferably on land.
- Choose a cool and dry spot to store the boat. Ensure protection against rodents and other vermin, as they feed on the fabric of the boat.
- The boat may be stored inflated, but do not place any heavy or sharp objects on it. Hanging the boat is not recommended.
- If you're planning to leave your boat outside, make sure to keep it raised up off the ground. It is also a good idea to keep it covered so that it is not directly exposed to berries, leaves, rain, sunlight and other elements. Boats that are left in water should be emptied from time to time.
- Store the product and accessories in a dry place, with temperature controlled between 32 degrees Fahrenheit (0 degrees Celsius) and 104 degrees Fahrenheit (40 degrees Celsius).

LEAK DETECTION AND REPAIR

AIR LEAK DETECTION

If your boat appears a bit soft, it might not be because of a leak. If the boat was inflated late in the day with 32°C (90°F) air, that air might cool down to 25°C (77°F) overnight. The cooler air exerts less pressure on the hull, so it could appear soft the next morning. If there has been no temperature variation, you need to start looking for a leak:

- Take a good look at your boat from just a few feet away. Flip it over and closely check over the outside. Any large leaks should be clearly visible.
- If you have an idea where your leak is, use a mix of dishwashing liquid and water in a spray bottle, and spray over the suspicious areas. Any leak will produce bubbles that will pinpoint the location of the leak.
- Check valves for leak, if necessary, spray soapy water around the valve and the valve base.

SMALL REPAIRS

Inadvertent punctures can be repaired using vinyl repair patch (included) and vinyl glue (excluded). You can also purchase additional PVC or silicon based glue for repairing camping mats, tents or shoes from your local market to patch your boat. Please refer to the instruction of the glue for patching.

1. Thoroughly clean and dry the damaged area. Completely deflate the product.
2. Cut a portion of the patch to cover the puncture and allow an additional 1/4" on all sides. Always cut a round patch, never leave square corners.
3. Be sure the repair area is completely dry.
4. Apply generous coat glue to the vinyl repair patch and to the product.
5. Allow the glue to dry for 2 to 3 minutes, or until the glue becomes tacky.
6. Apply the patch to the product, using your thumb or finger; apply even pressure across the entire surface of the patch. Make sure the edges of the patch are pressed down along the entire diameter.
7. Allow the product to dry for at least 12 hours before inflating and using.

If there are large tears/cracks, please bring the water craft or any essential equipment part into a professional repair shop for appropriate repair or replacement.

HOW TO FIX A LEAKING VALVE

A. Try to tighten the valve

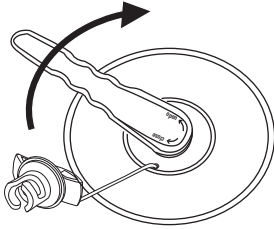

1. Inflate your DWF air deck floor up to the max air pressure.
2. Stick your valve wrench down inside of valve and turn clockwise to tighten the valve back down onto the DWF air deck floor.

B. Re-install or replace a valve

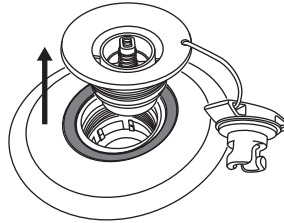
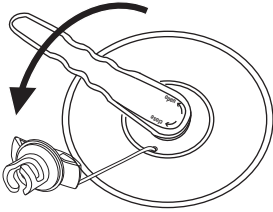

1. Completely deflate your DWF air deck floor.
2. Undo the dust cap and insert the valve wrench into the valve and twist counterclockwise to remove the valve.

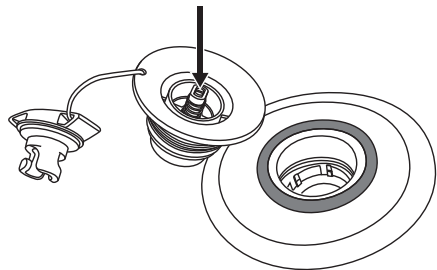
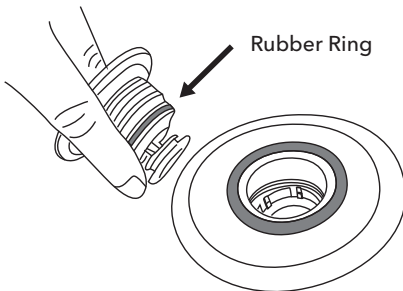

3. Check the rubber ring to make sure that it is in the correct position, tight around the valve and there is no debris in the way.
4. Be sure the pin spring is functioning properly and there are no cracks along the edges.

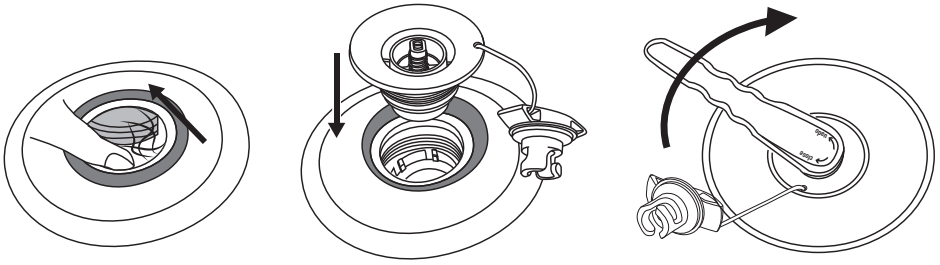

5. Ensure there are no strings from the drop stitching material.
6. Note the bottom piece of the valve is not attached to anything.
7. Fit the valve back into your DWF air deck floor.
8. Align all the threads and twist to tighten.
9. Once the valve is hand tight, use the valve wrench to seal completely.



NOTE: Correctly use the wrench by pressing it with one hand on top.

WARRANTY

AM warrants this product to be free from major defects in material or workmanship to the original purchaser for a period of ONE (1) Year from the date of purchase. This warranty is subject to the following limitations:

1. The warranty is valid only when this product is used for normal recreational activities and does not cover products used in rental or school operations.
2. AM will make the final warranty determination, which may require inspection and/or photos of the equipment, which clearly show the defect(s). If necessary, this information must be sent to the AM distributor in your country with prepaid postage. Product can be returned only if a return authorization number is given in advance by the AM distributor. The return authorization number must be clearly labeled on the outside of the package, or it will be refused.
3. If a product is deemed to have manufacturing defect, the warranty covers the repair or replacement of the defective product only. AM will not be responsible for any costs, losses, or damages incurred as a result of loss or use of this product.
4. This warranty does not cover damage caused by misuse, abuse, neglect, normal wear and tear including, but not limited to, punctures, damage due to excessive heat exposure, damage caused by improper handling and storage, damage caused by use in waves or shore break, boat breakage caused by filling or crashing in surf conditions, or damage caused by anything other than defects in material and workmanship.
5. This product must not be used in excess of the manufacturers recommended maximum load capacity.
6. This warranty is void if any unauthorized repair, change or modification has been made to any part of the equipment.
7. The warranty for any repaired or replacement equipment is good from the date of the original purchase only.
8. The original purchase receipt must accompany all warranty claims. The name of the retailer and date of purchase must be clear and legible.
9. There are no warranties that extend beyond the warranty specified here in.



This product is designed in accordance with standards for a specific use. Any modifications or transformations higher than that indicated by the manufacturer could result in serious risks for the user and will void the warranty.

© **Oriental Recreational Products (Shanghai) Co., Ltd**

®™Trademarks used in some countries of the world under license to / ®™marques utilisées sous licence de /
Marcas registradas utilizadas en algunos países del mundo bajo licencia de / Das®™ Warenzeichen wird in
einigen Ländern der Welt unter der Lizenz davon benützt / Oriental Recreational Products (Shanghai) Co., Ltd.,
No.1699, Daye Road, Shanghai, China 201402 • Represented in the European Union by / Représenté dans
l'Union européenne par / Innerhalb der Europäischen Union vertreten durch / Representado en la Unión
Europea por ORPC SAS 250bis bd Saint-Germain 75007 Paris - France • Represented in the UK by / Représenté
au Royaume-Uni par / Innerhalb des Vereinigten Königreichs vertreten durch / Representado en Reino Unido
por Marine & Outdoor Ltd. Birch Farm, Brooks Road, Raunds, Wellingborough NN9 6NT, UK