



# INTELLICHLOR®

## SALT CHLORINE GENERATOR

Model IC15



## INSTALLATION AND USER'S GUIDE



REGISTRATION NO. 30931  
PEST CONTROL PRODUCTS  
ACT DOMESTIC

Pentair Water Pool and Spa, Inc.  
10951 West Los Angeles Ave.,  
Moorpark, CA 93021  
USA. (800) 831-7133  
(800) 553-5000

IMPORTANT SAFETY INSTRUCTIONS  
READ AND FOLLOW ALL INSTRUCTIONS  
SAVE THESE INSTRUCTIONS  
KEEP OUT OF REACH OF CHILDREN

## **Technical Support**

**Sanford, North Carolina** (8 A.M. to 5 P.M. Eastern Time)

**Moorpark, California** (8 A.M. to 5 P.M. Pacific Time) **Phone:** (800)  
831-7133

**Fax:** (800) 284-4151

### **Download the IntelliChlor User's Guide (PDF)**

<http://www.pentairpool.com/pdfs/IntelliChlorOM.pdf>

<http://www.pentairpool.com/pdfs/IntelliChlorIC15IG.pdf>

## Contents

<b>Important Warnings and Safety Instructions .....</b>	<b>i - iv</b>
IntelliChlor Salt Chlorine Generator Overview/Features.....	1
IntelliChlor System Components .....	2
IntelliChlor Salt Chlorine Generator Control Panel and Cell Description .....	2
IntelliChlor IC15 Power Supply .....	3
System Schematic Diagram .....	4
Install Chlorine/Bromine Feeders after the Intellichlor cell .....	4
Loop Plumbing Diagram .....	5
IntelliChlor Plumbing Diagram .....	5
<b>Section 1: IntelliChlor SCG Control Panel .....</b>	<b>7</b>
Salt Level Status LEDs .....	7
Status LEDs .....	7
Sanitizer Output LED Indicators .....	8
More and Less Output Buttons .....	8
Self-Cleaning .....	8
<b>Section 2: Pool Water and Chemistry, Conditions and Precautions .....</b>	<b>9</b>
Pool Water Chemistry, Conditions and Precautions .....	9
Optimum Pool Water Conditions for Salt Water Pools (using the IntelliChlor Salt Chlorine Generator ) .....	10
Covered Pools and Vinyl Liner Pool and Lowering Chlorine Output Levels .....	10
Chlorine Testing .....	11
What Type of Salt to Use .....	11
How Much Salt to Use? .....	11
Calculating the Saturation Index .....	12
TDS Factor .....	12
Langelier Saturation Index Factors .....	12
How to Add Salt to the Pool .....	13
Table 1. Approximate Pounds (Kg) of salt needed to obtain 3,400 ppm in pool .....	13
Table 2. Approximate amount of stabilizer (cyanuric acid) to obtain 40 ppm in pool .....	14
Pool Water Preparation .....	14
Determining Pool Size (Gallons of Water in Your Pool) .....	14
Determining Pool Size (liters of water in your pool) .....	14
<b>Section 3: Operating IntelliChlor SCG.....</b>	<b>15</b>
Initial Start-Up Period .....	15
Operation .....	15
Use of an external Pool Pump Timer is not required .....	15
If you use a Pool Pump Timer .....	15
Startup Procedure (Super Chlorination) .....	16
Sanitizer Output Settings and Adjustments .....	16
Operating in Winter .....	16
General Recommendations .....	17
General Cautions .....	17
<b>Section 4: User Maintenance .....</b>	<b>19</b>
Daily service .....	19
Weekly service .....	19
Monthly Service .....	19
SCG Usage Hours Meter .....	20
Cleaning the SCG Cell Blades .....	20
Winterizing .....	21

## Contents

<b>Section 5: Installation .....</b>	<b>23</b>
Kit Contents .....	23
Required Tools .....	23
IntelliChlor “Dummy” Cell .....	24
Installing the IntelliChlor Cell Assembly .....	24
Connecting the Cell Power Cable to the Power Center .....	24
Connecting the Power Supply Cable to the IC15 Cell .....	25
<b>Section 6: Troubleshooting .....</b>	<b>25</b>
Table 1: Troubleshooting .....	26
IC15 System Specifications and Wiring .....	27
Warranty Information .....	28

## IMPORTANT WARNINGS AND SAFETY INSTRUCTIONS

### SAVE THESE INSTRUCTIONS



**Important Notice: Attention Installer:** This manual contains important information about the installation, operation and safe use of this product. This information should be given to the owner and/or operator of this equipment. When installing and using this electrical equipment, basic safety precautions should always be followed, including the following:



**⚠ WARNING: IMPORTANT SAFETY INSTRUCTIONS PERTAINING TO A RISK OF FIRE, ELECTRIC SHOCK, OR INJURY TO PERSONS. READ AND FOLLOW ALL INSTRUCTIONS.**

Before installing this product, read and follow all warning notices and instructions which are included. Failure to follow safety warnings and instructions can result in severe injury, death, or property damage. Call (800) 831-7133 for additional free copies of these instructions, or obtain a copy of these instructions at:  
[http://www.pentairpool.com/misc/owners\\_manuals/sanitizers/IntelliChlor\\_Owners.pdf](http://www.pentairpool.com/misc/owners_manuals/sanitizers/IntelliChlor_Owners.pdf)



**WARNING:** To reduce the risk of injury, do not permit children to use this product.



**WARNING: CHLORINE GAS BUILDUP CAN OCCUR WITH IMPROPER WIRING:** To reduce the risk of personal injury the IntelliChlor® Salt Chlorine Generator (SCG) Power Center must be installed on and wired to the load side of the time clock, electronically controlled switch, or relay load side, so that it will receive power only when the pool pump is on. Otherwise, dangerous chlorine gas buildup can occur. The SCG should never be energized when the pool pump is OFF and water is not flowing through the unit.



**WARNING:** To reduce the risk of injury, service should only be performed by a qualified pool service professional.



**WARNING:** Never operate the IntelliChlor Salt Chlorine Generator (SCG) without proper flow or water circulation. A build-up of flammable gases will result in hazardous conditions.









**CAUTION -** IntelliChlor Salt Chlorine Generator (SCG) is for use with permanently-installed pools and may also be used with hot tubs and spas if so marked. Do not use with storable or steel pools. A permanently-installed pool is constructed in or on the ground or in a building such that it cannot be readily disassembled for storage. A storable pool is constructed so that it is capable of being readily disassembled for storage and reassembled to its original integrity.





**CAUTION -** When using the IntelliChlor Salt Chlorine Generator (SCG) it is required to use a ground fault circuit-interrupter (GFCI) to protect the circuit. The power supply must be interconnected with pool pump motor power source. This insures the SCG and pool pump will switch on and off together.

## IMPORTANT WARNINGS AND SAFETY INSTRUCTIONS

-  **CAUTION** - Use of chemicals other than those recommended may be hazardous. Even proper use of the recommended chemicals can be hazardous. Follow the Chemical Manufacturer's Instructions.
-  **CAUTION** - To reduce the risk of electric shock, install IntelliChlor® Salt Chlorine Generator (SCG) a minimum of 1.5 m (5 ft) away from the inside wall of the pool.
-  **CAUTION** - Install the SCG a minimum of 90 cm (3 ft) away from the heater outlet.
-  **CAUTION** - A solid copper, bonding conductor not smaller than No. 8 AWG (8.4 mm) should be connected from the accessible wire connector on the unit to all metal parts of the swimming pool, spa, or hot tub structure and to all electrical equipment, metal conduit, and metal piping within 1.5 m (5 ft) of the inside walls of a swimming pool, spa, or hot tub, when the unit is installed within 1.5 m (5 ft) of the inside walls of the swimming pool, spa, or hot tub.

  **WARNING:** When mixing acid with water;  
**ALWAYS ADD ACID TO WATER. NEVER ADD WATER TO ACID.**

**Canada - Industry Canada (IC)** - This device complies with RSS210 of Industry Canada. (1999)

-  **CAUTION** - The **IC15 Power Supply** must be interconnected with pool pump motor power source. This ensures the SCG and pool pump will switch on and off together. When the IC15 (SCG) is installed in Europe, IC15 (SCG) Power Center supply fuses should **ONLY** be obtained from the manufacturer.
-  **CAUTION** - The **IC15 Power Supply** is only intended for use with the IC15 cell, **DO NOT PLUG ANY OTHER INTELLICHLOR CELL INTO THIS POWER SUPPLY, SEVERE DAMAGE WILL RESULT.**

!

## IntelliChlor® Salt Chlorine Generator (SCG) Overview

The IntelliChlor® Salt Chlorine Generator IC15 (SCG) salt chlorinator uses a process known as electrolysis to produce chlorine gas which immediately dissolves into a solution to create Hypochlorite and Hypochlorous acid pool and spa water sanitizer from a low concentration of salt added to the pool water. Hypochlorite and Hypochlorous kill bacteria, oxidizes organic material, and kills algae, then reverts back to salt. The SCG then reuses the salt and the process starts over again. The IntelliChlor system is comprised of the SCG and Power Center.

### CAUTION

The IntelliChlor Salt Chlorine Generator (SCG) is designed only to produce chlorine. The SCG does not monitor or control chlorine levels in the pool or spa water. It is the pool owner's responsibility for monitoring and maintaining free chlorine levels at 1-3 ppm for pools and 3-5 ppm for spas. It is the pool owner's responsibility to check, on a regular basis, the free chlorine level while the pool pump is running, and adjust the IntelliChlor Salt Chlorine Generator accordingly.

### WARNING

Salt is an inherently corrosive material. While the levels of salt required for proper operation of the IntelliChlor Salt Chlorine Generator are relatively low when compared to sea water and other salt solutions, placing any amount of salt in your pool increases the likelihood of corrosion or other deterioration of pool equipment and any surfaces used in and around your pool. Metal parts (including steel pools) and certain natural and man-made surfaces are particularly susceptible to corrosion and deterioration when used in and around salt water pools. Pentair Water Pool and Spa ("Pentair") does not represent or otherwise guarantee that the proper use of the IntelliChlor Salt Chlorine Generator will prevent corrosion or other deterioration of pool equipment and any surfaces used in and around your pool. Consult your experienced pool professional, who should be able to advise you on the proper material selection, installation techniques for those materials, and the proper use, care and maintenance of those materials for your specific pool type and location in order to minimize the corrosion and deterioration that is inherent in and around salt water pools.

### CAUTION

**FOR ALL NEWLY CONSTRUCTED OR RESURFACED PLASTER POOLS: Do not operate the SCG with newly poured or resurfaced pool plaster. Salt is a corrosive element and severe salt damage can occur to your pool. Wait at least ONE (1) MONTH after construction to allow plaster to cure before adding salt and operating SCG. Follow the pool surface manufacturer's guidelines for your specific pool.**  
**FOR NEW VINYL LINER POOLS, contact the manufacturer for recommended guidelines before adding salt and operating the IntelliChlor SCG.**

## Features

- Superior design combines cell and control panel as one assembly.
- Cell blades are made from a titanium metal base and coated with precious metal Ruthenium oxide.
- Cell blades are capable of producing chlorine for at least 10,000 hours, when the SCG is used properly.
- The SCG can be installed horizontally or vertically.
- Separate Power Center mounts to wall at equipment pad, for easy AC wiring.
- Electronics run cool for long, reliable life.
- Cell hour meter reports current usage to determine how many hours remain in the life of the unit.
- IC15 produces up to 0.278 kg of chlorine per day
- Head Loss of the SCG system installed into the main line is less than 6.9 kPa (1 psi).
- Salt level LED indicators show three ranges for the amount of salt in pool.
- Red and green LED indicators show system status for water flow, cell status and cold water.
- MORE and LESS output buttons control how much chlorine is produced.
- BOOST cycle sets the unit to maximum chlorine output for 24 hours of pump run time.
- UL listed to UL1081 standards for swimming pool chlorinators.
- Approved NSF regulatory standards, and CE certified.

## IntelliChlor® SCG System Components

An IntelliChlor® Salt Chlorine Generator system consists of one or more of the following:

- **IC15 Cell and Power Center (P/N 520888):** Designed for pools up to 56 800 L (15,000 Gal) and spas up to 55,600 L (14,688 Gal). The cell will produce the equivalent of 0.278 kg of pure chlorine per 24 hours of continuous pool pump run time.
- **IntelliChlor “dummy” bypass cell (P/N 520588):** For new pool start-up.

## IntelliChlor SCG Control Panel and Cell Description

The IntelliChlor Salt Chlorine Generator (SCG) includes a control panel with buttons and LED indicators to control the SCG and produce chlorine. The SCG measures the water temperature and salt level to produce chlorine at the defined output. If the salt level in the pool water is too low (red on salt display), the cell is turned off until salt is added to the pool. The controller has a self-cleaning cycle which reverses the cell polarity, reducing calcium buildup. This feature turns the cell on and off at regular intervals to minimize calcium and scale buildup and further maximizes cell life.

The SCG contains the control electronics and bipolar electrodes that electrically produce chlorine when energized with DC current. Chlorine is generated as pool water containing salt passes through the cell. The chlorine production can be varied by either adjusting the sanitizer output level on the control panel and/or by varying the number of hours the SCG is on each day. ***The SCG automatically reverses the cell electrode blades every few hours to help clean the cell. This process does not interrupt the production of Chlorine.*** The SCG also contains a mechanical flow sensor to ensure the proper amount of water is passing through the cell to allow chlorination to occur. The SCG automatically measures the water salinity and temperature and displays three (3) salinity ranges on the control panel using LED indicators. The SCG includes a 4.5 m (15 ft.) UL approved four conductor 16-gauge cable for connection to the Power Center.

- **Flow Sensor:** A flow sensor assures that there will always be adequate water flow through the SCG. If the SCG is not properly plumbed and/or does not receive adequate water flow, no chlorine will be produced.
- **Temperature Sensor:** To protect the SCG from operation and potential damage when the temperature of the pool water falls below 11° C, ±1.67° C (52° F, ±3° F), the temperature sensor switches the SCG off, illuminates the COLD WATER light and no chlorine will be produced.
- **Salt Sensor:** Two (2) salt sensor probes in the SCG are activated each time the SCG is switched on and again during every 12 hours of continuous running. At each of those times, the salt level LED indicator lights flash in a scrolling sequence for two (2) minutes to indicate that the SCG is in analysis mode. After two (2) minutes, the LED indicators lights will signal one (1) of three (3) salinity ranges. For more information, see “Salt Level Status LEDs” on page 7.

**Note:** The salt sensor reading is within +/- 500 ppm accuracy.



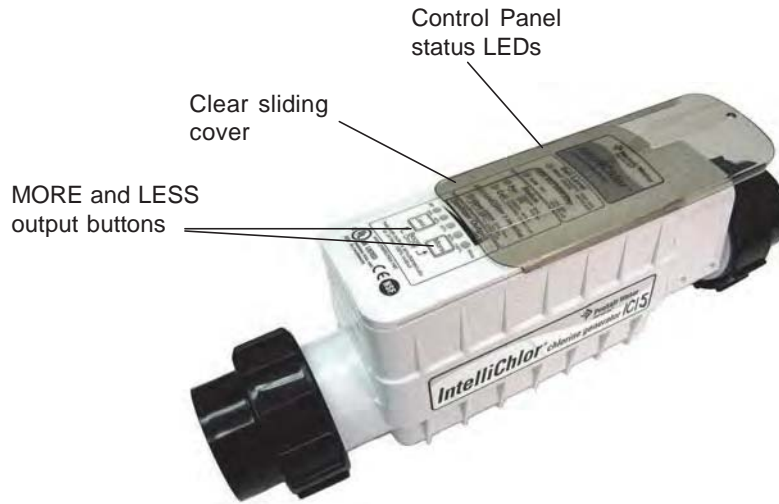

IntelliChlor® Salt Chlorine Generator

### IntelliChlor® SCG Power Supply

The IntelliChlor Power Supply converts AC electrical current to a low-voltage AC electrical current which is required to produce chlorine. The Power Supply is connected with the pool circulation pump electrical source so that the SCG only operates when the pool pump is on. A 4.5 m (15 ft). cord connected to the IC15 unit plugs into the Power Supply which plugs directly into a 110VAC outlet. The Power Supply can be mounted vertically on the wall up to 4.5 m (15 ft) away from the SCG.. The Power Supply contains the transformer, fuse (1 AMP 250 V, 3 AG), connector to the cell and the AC electrical cord with plug. There are no other controls or lights on the Power Supply. The Power Supply must be connected to a GFCI protected outlet.

**⚠ CAUTION** - The IntelliChlor Power Supply does NOT control the pump. The IntelliChlor Salt Chlorine Generator, model IC15 only produces chlorine when the pool pump is on.



IntelliChlor® Salt Chlorine Generator External Power Supply

**⚠ CAUTION** - First switch OFF AC power to the Power Supply before plugging or unplugging the IntelliChlor SCG IC15.

## System Schematic Diagram

The following schematic diagram shows a typical IntelliChlor® SCG system installation.

**Note:** This schematic diagram is not drawn to scale. Refer to the relevant portions of this Installation and User's Guide for information regarding proper placement and spacing of all equipment depicted in this diagram.

### Install Chlorine/Bromine Feeders after the IntelliChlor SCG Cell

**⚠ CAUTION** - To avoid permanent damage to the IntelliChlor cell, automatic in-line chlorine/bromine feeders (such as Pentair Water Pool and Spa® Rainbow models) **MUST** be installed **AFTER** the IntelliChlor cell as shown below. When using the IntelliChlor with an in-floor cleaner pressure system, it is recommended that a separate return line be used for the cleaner to reduce the increased water pressure stress on the IntelliChlor cell.

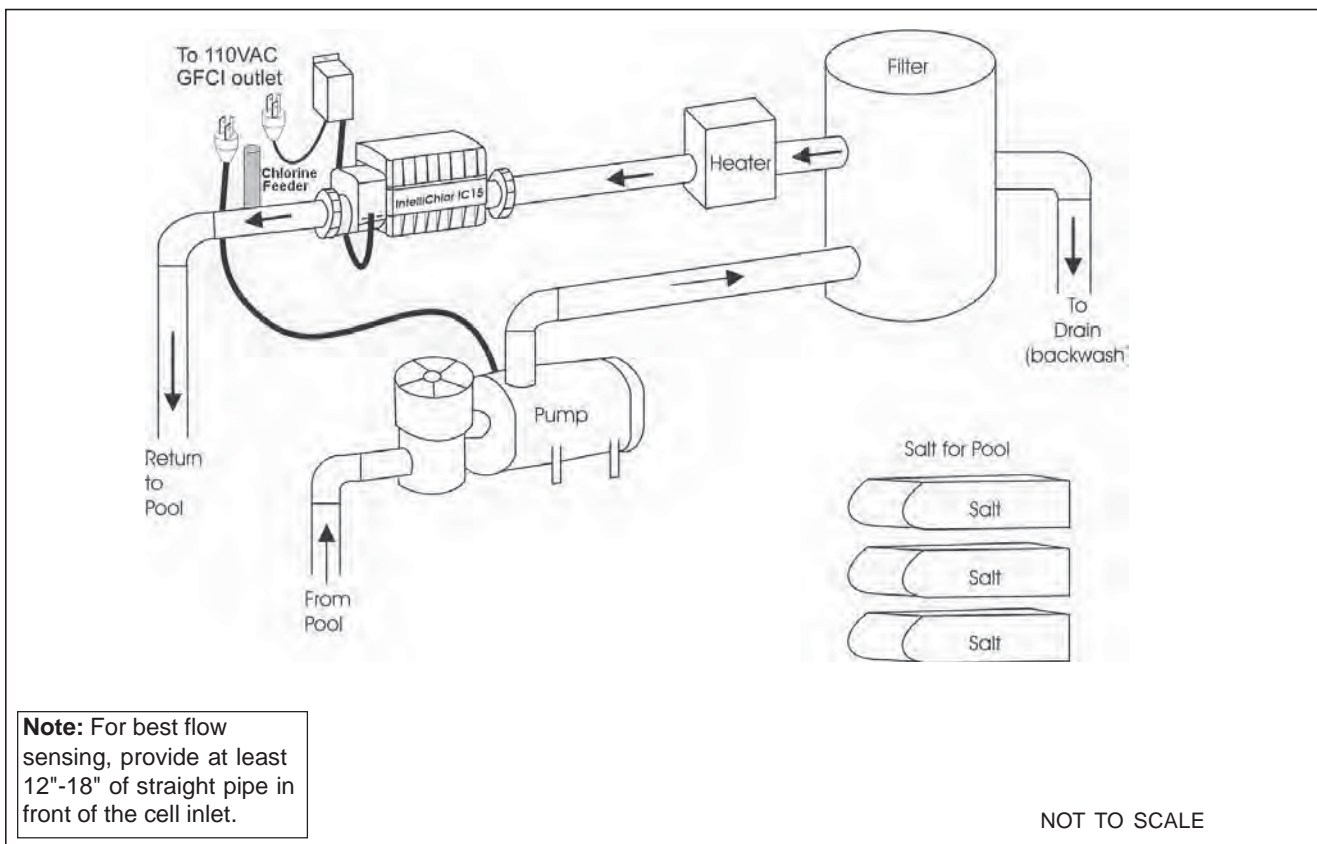

## Loop Plumbing Diagram

The IntelliChlor® SCG is designed to operate with water flow rates from 95 Litres per minute (Lpm) (25 gallons per minute (gpm)) up to 397 Lpm (105 gpm). Do not exceed 397 Lpm (105 gpm) or pipe manufacturers recommended flow rate, whichever is less. For flow rates over 303Lpm (80 gpm) you must use a bypass loop (as shown below) for best chlorine production. Installations with flow rates over 303 Lpm (80 gpm) include those that have in-floor cleaning systems or booster pumps. These systems **MUST** use a bypass loop with the SCG with a flow control valve that assures that the flow through the SCG is maintained within its designed operating water flow rates.

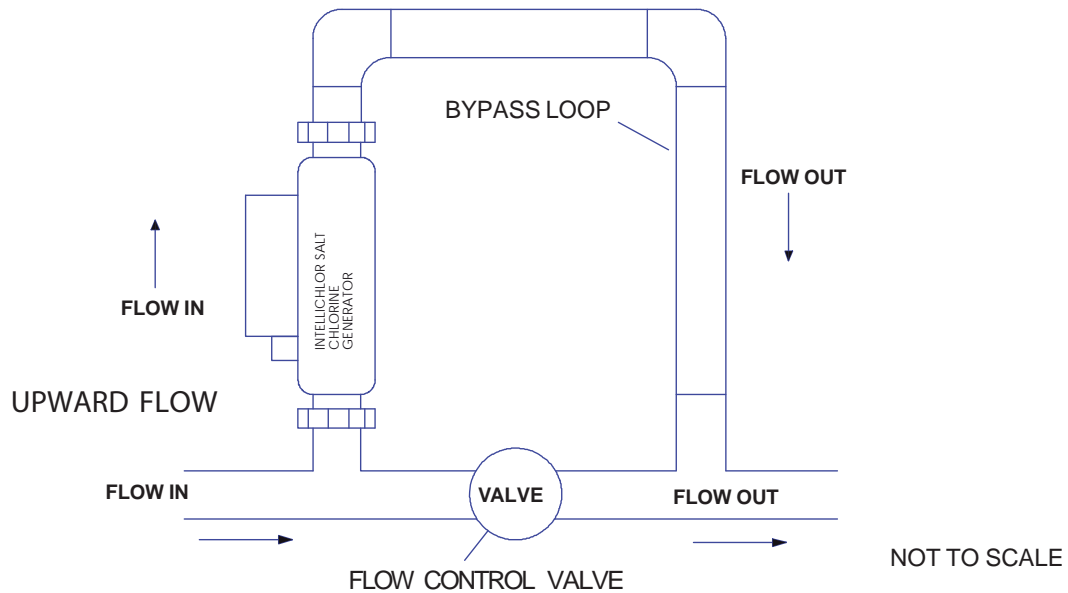

## IntelliChlor Plumbing Diagram

Plumbing the IntelliChlor Salt Chlorine Generator (SCG):

- Always install the SCG **AFTER** the filter and heater (see “System Diagram” on page 4). The ICEG should be no closer than 90 cm (3 ft) away from the heater outlet.
- If the SCG is installed on a pool/spa combination system, install (see diagram below) the SCG **BEFORE** the pool/spa return valve to allow proper chlorination of both the pool and spa and also to avoid creating gas traps in the pipes.

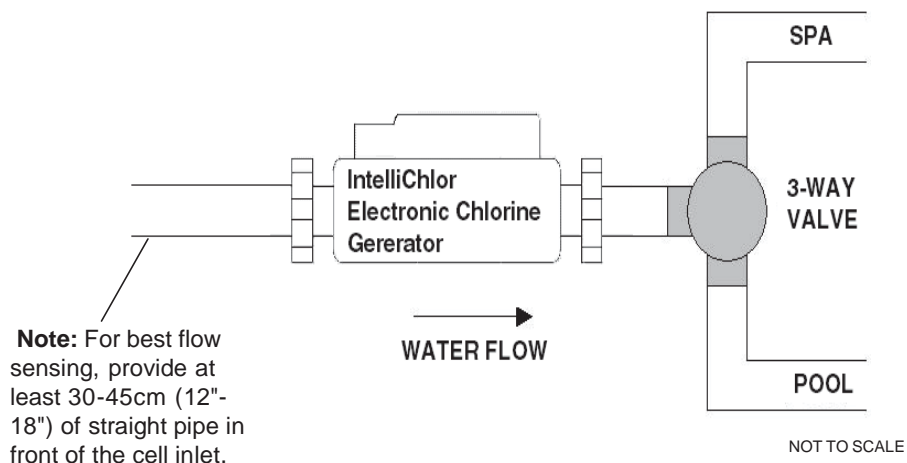

Blank Page

# Section 1

## IntelliChlor<sup>®</sup> SCG Control Panel

### Salt Level Status LEDs

The SCG salt level checks the pool water daily and displays the levels as follows:

**Green LED: Good salt.** The pool water salt level is between 2800 ppm and 4500, and the SCG is producing chlorine. SCG salt LED should always be showing GREEN level for better results.

**Green LED (Flashing):** Salt level is above 4500 ppm. Chlorine is being produced but the salt level is too high which increases the risk of corrosion and deterioration of pool equipment and surfaces in and around the pool. Pool water needs to be drained and refilled 30 cm (1ft) at a time until the salt level is below 4500 ppm.

**Red LED:** Low salt. The water salt level is below 2800 ppm. The SCG will be producing chlorine at reduced efficiency. It is highly recommended to add salt. See (\*) Note below.

**Red LED:** Very low salt. The water salt level has fallen below 2600 ppm. The SCG will not produce chlorine until salt is added. The SCG is OFF. See (\*) Note below.

**NOTE (\*):** After every salt addition, pump should be allowed to run for at least 24 hours for proper dilution. Salinity readings should only be taken, after the dilution period.

DO NOT take salinity readings during the dilution period, otherwise readings WILL NOT be accurate.

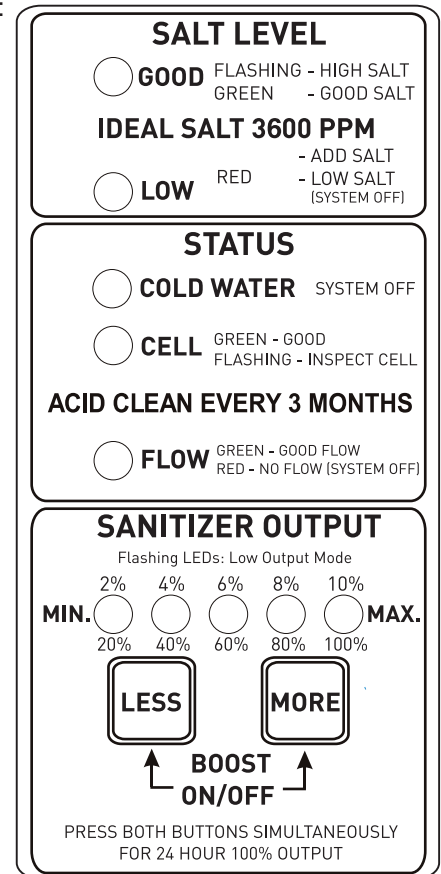

### Status LEDs

**Cold Water:** Shows the IntelliChlor Salt Chlorine Generator power status:

- **No Light:** The SCG is operating in the normal temperature range > 11° C (> 52° F).
- **Red:** The SCG is in "Standby" mode (system off, no chlorine production) due to a cold water condition. The SCG will resume to normal operation mode, including accurate salinity report, once water temperature goes above 11° C (52° F).

**Cell:** Shows the status of the SCG.

- **Green (flashing):** The SCG needs to be inspected. The blades may have calcium buildup. The SCG is not producing chlorine.
- **Green:** SCG is good and producing chlorine

**No Light:** SCG is off and not producing chlorine. It may be in an off-period of the sanitizing cycle and will return on shortly. This light will also be blank if the water temperature is below 11° C +/- 1.67° C (52° F +/- 3° F). This cold water cutoff mode extends the blade life.

**Flow:** This light indicates the status of water flowing through the SCG.

- **Red:** Insufficient water flow through the SCG, no chlorine is being produced.
- **Green:** Sufficient water flow to produce chlorine.

## Operator Control Panel (continued)

### Sanitizer Output LED Indicators

The five (5) LED indicators display as a bar graph to show in 20% increments, the percentage of time the chlorine is produced per hour of pump run time. In BOOST mode, these LEDs (blink from left to right).

*Note: If no LEDs are lit, the output is set to 0% and the SCG is not producing chlorine.*

- 0% - No LEDs lit - No chlorine produced – IntelliChlor Salt Chlorine Generator is off.
- 20% - 1 LED lit - Produces chlorine 20% of each hour of pump run time, 12 minutes on, 48 minutes off.
- 40% - 2 LEDs lit - Produces chlorine 40% of each hour of pump run time, 24 minutes on, 36 minutes off.
- 60% - 3 LEDs lit - Produces chlorine 60% of each hour of pump run time, 36 minutes on, 24 minutes off.
- 80% - 4 LEDs lit - Produces chlorine 80% of each hour of pump run time, 48 minutes on, 12 minutes off.
- 100% - 5 LEDs lit - Produces chlorine almost 100% of each the hour of pump run time, 59 minutes on, 1 minute off.

*Note: If connected to an IntelliTouch<sup>®</sup>, EasyTouch<sup>®</sup> or SunTouch<sup>®</sup> Control System, these lights may slowly flash when the output is set to a value not exactly 20%, 40%, 60% 80% or 100%. Example: 21% output setting from the Control System will flash the 20% light.*

### More and Less Output Buttons

The More and Less buttons control the percentage of time of each hour that the IntelliChlor Salt Chlorine Generator is producing chlorine while the pump is on (see Sanitizer Output LED indicators above). The lights act as a bar graph: the more lights that are on, the more that chlorine is produced. Slide the panel cover up to access the More, Less and Boost On/Off buttons. To exit **Boost** mode, press and hold both the **More** and **Less** buttons.

**More:** Increases the time the cell produces chlorine, in 20% increments. Example: The Sanitizer Output display is showing 20%. Pressing the **MORE** button once will turn on the 40% light. The unit will produce chlorine 40% of each hour the SCG is on. Pressing **MORE** again will turn on the 60% light, and so on until all five (5) lights are on.

**Less:** Decreases the time the cell produces chlorine, in 20% increments. Example: The Sanitizer Output display is showing 40%. Pressing the **LESS** button once will turn off the 40% light, leaving only the 20% light. The unit will produce chlorine 20% of each hour the SCG is on. Pressing **LESS** again will turn off the 20% light, leaving no lights on, no chlorine is produced.

**Boost On/Off:** Press and hold both the **More** and **Less** buttons together to activate Boost mode on or off. Boost mode sets the sanitizer output to run 100% for the next 24 hours of pool pump run time. If the time clock switches off the pump cycle, then switches power back on the next day, Boost mode will continue until 24 hours has elapsed since Boost mode was turned on or Boost mode is canceled by the user. The Sanitizer Output display will show a pattern LED display to indicate Boost mode.

### Self-Cleaning

The self-cleaning feature reduces scale buildup on the blades of the SCG. The self-cleaning cycle tends to reduce the life of the SCG, therefore, it should be used only to the extent necessary to minimize the scale buildup on the blades. The self-cleaning cycle can be adjusted to run every 2, 3, 4, or 5 hours, whichever is the optimal for your particular pool conditions in order to minimize scale buildup but maximize the life of the SCG. It is factory set to two (2) hours for the first 30 days of operation, then automatically switches to three (3) hours. To change the self-cleaning cycle, press and hold the **LESS** button for three (3) seconds. The sanitizer output display will show the number of hours in a bar graph style. The number of output LEDs lit is the number of reverse hours. Pressing **More** or **Less** button will change this setting.

**Example:** The self-clean cycle is set to run for four (4) hours and the pool owner chooses to change it to three (3) hours to optimize the blade cleaner cycle for your particular pool conditions. Press and hold the **LESS** button for three (3) seconds. The sanitizer output display will blank, then light up the 20%, 40%, 60% and 80% lights, four (4) total. This is a four (4) hours reverse setting. Pressing the **LESS** button once within ten (10) seconds will switch off the 80% light, leaving only three (3) lights on, now at a three (3) hours reverse setting. Wait ten (10) seconds and this mode will end automatically, returning to the original sanitizer output display.

## Section 2

# Pool Water Chemistry, Conditions and Precautions

This section describes the start-up procedure and operating instructions for IntelliChlor® Salt Chlorine Generator (SCG).

## Pool Water Chemistry, Conditions and Precautions

1. **New Pool Water:** A recently filled or newly-refinished pool may contain undesirable matter. This undesirable matter could interfere with SCG's ability to chlorinate properly. Make sure the water is tested by a pool professional and properly balanced before switching on the SCG.

**⚠ WARNING** - Salt is an inherently corrosive material. While the levels of salt required for proper operation of the IntelliChlor Salt Chlorine Generator are relatively low when compared to sea water and other salt solutions, placing any amount of salt in your pool increases the likelihood of corrosion or other deterioration of pool equipment and any surfaces used in and around your pool. Metal parts (including steel pools) and certain natural and man-made surfaces are particularly susceptible to corrosion and deterioration when used in and around salt water pools. Pentair Water Pool and Spa ("Pentair") does not represent or otherwise guarantee that the proper use of the IntelliChlor Salt Chlorine Generator will prevent corrosion or other deterioration of pool equipment and any surfaces used in and around your pool. Consult your experienced pool professional, who should be able to advise you on the proper material selection, installation techniques for those materials, and the proper use, care and maintenance of those materials for your specific pool type and location in order to minimize the corrosion and deterioration that is inherent in and around salt water pools.

2. **Super Chlorination** burns out the swimmer waste that has combined with chlorine. This frees the chlorine for sanitizing. This is accomplished by raising the chlorine level quickly and dramatically. When the chlorine level is raised to ten (10) times the amount of combined chlorine (usually 5 to 10 ppm) the pool water is said to have been super chlorinated. As pool water is continuously passed through the SCG while the unit is powered on, all pool water inside the SCG is being super chlorinated. When the IntelliChlor Salt Chlorine Generator is used on pools, the pool water sparkles is less likely to contain chloramines.  
*Note: On initial start-up of a pool, it is best to super chlorinate using an outside source, i.e., use a shock treatment available at your local pool supplier.*
3. **Chloramines** should not be present in pool water. Chloramines are formed when ammonia (which is found in urine and sweat) combine with free chlorine. This ties up the free chlorine in your pool and does not allow the chlorine in your pool to disinfect. Chloramines also burn the eyes and are foul smelling. Super Chlorinate to remove chloramines at the initial start-up of the pool and as needed to maintain proper levels of free chlorine.
4. **Cyanuric acid** is needed in outdoor pools to help to stabilize and maintain proper levels of chlorine. 90% of unstabilized chlorine is destroyed by the UV radiation from the sun within two hours. Cyanuric acid stabilizes chlorine in water from UV degradation. When using the SCG, the cyanuric acid level should be maintained between 30-50 ppm. See Table 2, on page 14. **NOTE: DO NOT USE CYANURIC ACID IN INDOOR POOLS.**
5. **Total Dissolved Solids (TDS):** Adding salt to pool water will raise the TDS level. While this does not adversely affect the pool water chemistry or clarity, the pool water professional testing for TDS must be made aware salt has been added to the IntelliChlor system. The individual performing the TDS test (see page 20) may then subtract the salinity level to arrive at a TDS level that would be compatible to a TDS reading for a non-salt water pool.

6. **Metals** - Some metals, i.e. copper and iron, can cause loss of chlorine. Also, metals can stain your pool. Metals can also damage the IntelliChlor<sup>®</sup> Salt Chlorine Generator. Have your local pool professional check for metals and recommend methods of removal.
7. **Nitrates and Phosphates** can cause extremely high chlorine demands and will deplete chlorine from your swimming pool. In some cases nitrates may even lower your chlorine levels to zero. Your local pool professional can test for nitrates and phosphates. While a 0 ppm level of nitrates is the ideal, the pool owner should make sure that nitrates **DO NOT** exceed 10 ppm. Phosphates should not exceed 125 parts per billion (ppb).

## Optimum Pool Water Chemistry Conditions for Salt Water Pools

### (using the IntelliChlor Salt Chlorine Generator )

In accordance with the Association of Pool and Spa Professionals (APSP) standards, it is recommended that the following pool water chemistry conditions be maintained on an on going basis to help protect pool users, pool related equipment and surfaces in and around the pool. These values are important to maintaining the pool equipment in proper operating condition and preventing corrosion, liming or other problems. The IntelliChlor Salt Chlorine Generator is warranted to operate properly only if these conditions are met. For more information, refer to your local agency having jurisdiction, NSPI (National Spa and Pool Institute), the CDC (Centers for Disease Control), or the WHO (World Health Organization).

**Free Chlorine:** 1-3 ppm for pools and 3-5 ppm for spas. Above 4.0 ppm may cause corrosion of metal components

**Combined Chlorine (Chloramines):** None (super chlorinate to remove all chloramines)

**pH:** 7.2 - 7.8 (USE MURIATIC ACID to lower pH and Soda Ash to raise pH for pools and spas)

**Cyanuric Acid:** 30 ppm - 50 ppm

**Total Alkalinity:** 100 ppm - 120 ppm for pools and spas

**Calcium Hardness:** 200 ppm - 300 ppm for pools / 150-200 for

spas **TDS (includes salt):** 3000 ppm minimum to 5700 to 6000 maximum

ppm **Salt:** 3000 ppm - 4500 ppm (ideal 3400 ppm)

**Metals (Copper, Iron, Manganese):** None

**Nitrates:** None

**Phosphates:** Less than 125 ppb

**Saturation Index** -.3 to .3 (zero (0) best)

## Covered Pools and Vinyl Liner Pool and Lowering Chlorine Output Levels

When using the IntelliChlor Salt Chlorine Generator with covered pools and/or vinyl liner pools, less chlorine is needed. It is recommend to lower the chlorine output level while the pool is covered. For more information about chlorine output levels, see “More or Less Output Buttons” page 8.



## Chlorine Testing

It is recommended that chlorine test samples be taken from two (2) locations in the pool. Compare the samples. A higher level should be found at the pool return line. The higher level at the pool return line indicates the SCG is producing chlorine. Take chlorine samples for testing at:

- The pool return line.
- 45cm (18 inches) below the surface and well away from the pool return line.

## What Type of Salt to Use

The purer the salt, the better the life and performance of the IntelliChlor® Salt Chlorine Generator . Use salt that is at least 99.8% pure NaCl, sodium chloride. The preferred and recommended salt is an evaporated, granulated, food quality, non-iodized salt with no additives. Consult your salt supplier.

- Avoid using salt with anti-caking agents (sodium ferrocyanide, also known as YPS or yellow prussiate of soda). Filling agents can cause some discoloration of fittings and surface finishes in pool.
- Water conditioning salt pellets are compressed forms of evaporated salt and may be used, but will take longer to dissolve. Such pellets could damage pool plaster and other surfaces in and around the pool.
- Do not use calcium chloride or potassium chloride as a source of salt. (Use sodium chloride only).
- Do not use Rock salt (insoluble impurities mixed with the rock salt can shorten the life of the SCG).

## How Much Salt to Use?

 **CAUTION - FOR ALL NEWLY CONSTRUCTED OR RESURFACED PLASTER POOLS:** Do not operate the SCG with newly poured or resurfaced pool plaster. Salt is a corrosive element and severe salt damage can occur to your pool. Wait at least ONE (1) MONTH after construction to allow plaster to cure before adding salt and operating SCG. Follow the pool surface manufacturer's guidelines for your specific pool.

FOR NEW VINYL LINER POOLS, contact the manufacturer for recommended guidelines before adding salt and operating the SCG.

Use the Table 1 chart (page 13) to determine how much salt will be needed. Most pools contain some salt, depending on the water source and chemicals used for sanitizing. Therefore, the pool owner must always test salt levels before adding salt. A hand held meter calibrated for NaCl (salt) can be used to determine the salt levels of the pool water. After the IntelliChlor Salt Chlorine Generator is powered on, the LED salt level lights will blink from bottom to top for two (2) minutes while it analyzes the pool water, then the LED indicators will show one (1) of four (4) salt level ranges. This solid light indicates the salt status of the pool.

- 3000 to 3500 ppm of salt is recommended for optimum water conditions.
- Low salt concentration below 2600 ppm will cause the unit to turn off
- High salt concentration above 4500 ppm may cause excessive corrosion or deterioration to pool equipment and surrounding surfaces in and around the pool.

*Note: Salt measurements will vary between measuring devices (salt test strips, electronic testers, and titration). The salt sensor reading is within +/- 500 ppm accuracy. For more troubleshooting information about high salt levels, see "Troubleshooting," on page 31.*

## Calculating the Saturation Index

The saturation index is a formula that relates pH, calcium and alkalinity in the pool water. A well balanced pool water will have a formula result range between -0.3 and 0.3. Outside this range, the pool water is out of balance, potentially damaging pool equipment or scaling the SCG. The equation to calculate Si is:

$$SI = pH + CHF + AF + TF + TDSF$$

Saturation Index	pH as tested	Calcium Hardness Factor	Alkalinity Factor	Temperature Factor	TDS Factor
------------------	--------------	-------------------------	-------------------	--------------------	------------

Cyanuric acid in the form of cyanurate ions contribute to alkalinity. Thus, a correction must be made to total alkalinity. We subtract 1/3 of the cyanuric acid level from the reading obtained in the total alkalinity test.

$$\text{Total Alkalinity} - \frac{1}{3} \text{Cyanuric Acid} = \text{Corrected Alkalinity}$$

This correction can be considerable in established pools with high cyanuric acid levels; for example, at 240 ppm cyanuric acid, the correction amounts to 80 ppm (240 ÷ 3 = 80).

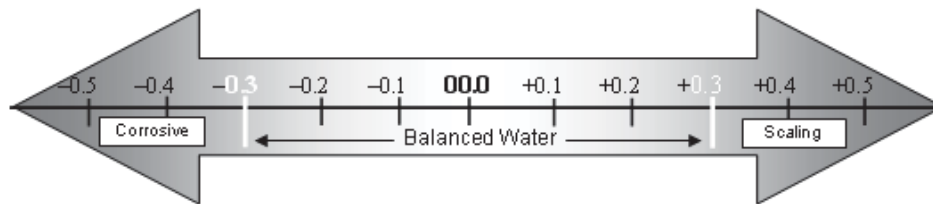

**TDS Factor** (Factors shown below are based on the actual measured value for the particular parameter)

TDS	Factor
<1000	12.10
1000	12.19
2000	12.29
3000	12.35
4000	12.41
5000	12.44

### Langelier Saturation Index Factors

Temperature		TF	Calcium Hardness		Total Carbonate Alkalinity	
°F	°C		ppm (mg/L)	CHF	ppm (mg/L)	AF
32	0.0	0.0	25	1.0	25	1.4
37	2.8	0.1	50	1.3	50	1.7
46	7.8	0.2	75	1.5	75	1.9
53	11.7	0.3	100	1.6	100	2.0
60	15.6	0.4	125	1.7	125	2.1
66	18.9	0.5	150	1.8	150	2.2
76	24.4	0.6	200	1.9	200	2.3
84	28.9	0.7	250	2.0	250	2.4
94	34.4	0.8	300	2.1	300	2.5
105	40.6	0.9	400	2.2	400	2.6
			800	2.5	800	2.9

**Note:** Use the reading closest to your actual reading in choosing the factor.

Total alkalinity in this context refer to the total of carbonate and bicarbonate alkalinity. If cyanuric acid is used, a correction factor must be used (see cyanuric acid Table 2 on page 14).

## How to Add Salt to the Pool

**⚠ CAUTION - FOR ALL NEWLY CONSTRUCTED OR RESURFACED PLASTER POOLS:** Do not operate the SCG with newly poured or resurfaced pool plaster. Salt is a corrosive element and severe salt damage can occur to your pool. Wait at least ONE (1) MONTH after construction to allow plaster to cure before adding salt and operating SCG. Follow the pool surface manufacturer’s guidelines for your specific pool. **FOR NEW VINYL LINER POOLS,** contact the manufacturer for recommended guidelines before adding salt and operating the SCG.

1. Check salt level in pool water before adding any salt to pool.
2. Determine the amount of salt from the following charts.
3. Slowly pour in the salt around the outer perimeter of the pool for quick and even distribution. ***To avoid clogging the filter or damaging pool related equipment and surrounding surfaces, do not add salt through the skimmer or surge tank.***
4. Brush the pool bottom and allow water to circulate for 24 hours to dissolve salt completely.
5. After 24 hours, verify correct salt level reading by checking the LED indicators on the IntelliChlor SCG and by a separate reliable test method.
6. Power on the IntelliChlor® Salt Chlorine Generator and set the Sanitizer Output level to the proper setting to maintain the appropriate free chlorine levels in the pool and spa water (i.e., within the 1-3 ppm for pools and 3-5 ppm for spas).

**Table 1.** Approximate pounds (lbs) / kilogram (kg) of salt needed to obtain 3,400 ppm in pool

CHART FOR ADDITION OF SALT TO 3400 PPM														
Pool Gallons		0 ppm	250 ppm	500 ppm	750 ppm	1000 ppm	1250 ppm	1500 ppm	1750 ppm	2000 ppm	2250 ppm	2500 ppm	2800 ppm	3000 ppm
10,000	lbs	284.00	263.12	242.24	221.35	200.47	179.59	158.71	137.82	116.94	96.06	75.18	50.12	33.41
	kg	128.82	119.35	109.88	100.41	90.93	81.46	71.99	62.52	53.04	43.57	34.10	22.73	15.16
12,000	lbs	340.80	315.74	290.68	265.62	240.56	215.51	190.45	165.39	140.33	115.27	90.21	60.14	40.09
	kg	154.59	143.22	131.85	120.49	109.12	97.75	86.39	75.02	63.65	52.29	40.92	27.28	18.19
14,000	lbs	397.60	368.36	339.13	309.89	280.66	251.42	222.19	192.95	163.72	134.48	105.25	70.16	46.78
	kg	180.35	167.09	153.83	140.57	127.31	114.05	100.78	87.52	74.26	61.00	47.74	31.83	21.22
16,000	lbs	454.40	420.99	387.58	354.16	320.75	287.34	253.93	220.52	187.11	153.69	120.28	80.19	53.46
	kg	206.12	190.96	175.80	160.65	145.49	130.34	115.18	100.03	84.87	69.72	54.56	36.37	24.25
18,000	lbs	511.20	473.61	436.02	398.44	360.85	323.26	285.67	248.08	210.49	172.91	135.32	90.21	60.14
	kg	231.88	214.83	197.78	180.73	163.68	146.63	129.58	112.53	95.48	78.43	61.38	40.92	27.28
20,000	lbs	568.00	526.24	484.47	442.71	400.94	359.18	317.41	275.65	233.88	192.12	150.35	100.24	66.82
	kg	257.64	238.70	219.76	200.81	181.87	162.92	143.98	125.03	106.09	87.14	68.20	45.47	30.31
22,000	lbs	568.00	526.24	484.47	442.71	400.94	359.18	317.41	275.65	233.88	192.12	150.35	100.24	66.82
	kg	257.64	238.70	219.76	200.81	181.87	162.92	143.98	125.03	106.09	87.14	68.20	45.47	30.31
24,000	lbs	681.60	631.48	581.36	531.25	481.13	431.01	380.89	330.78	280.66	230.54	180.42	120.28	80.19
	kg	309.17	286.44	263.71	240.97	218.24	195.51	172.77	150.04	127.31	104.57	81.84	54.56	36.37
28,000	lbs	795.20	736.73	678.26	619.79	561.32	502.85	444.38	385.91	327.44	268.96	210.49	140.33	93.55
	kg	360.70	334.18	307.66	281.14	254.61	228.09	201.57	175.05	148.52	122.00	95.48	63.65	42.44
30,000	lbs	852.00	789.35	726.71	664.06	601.41	538.76	476.12	413.47	350.82	288.18	225.53	150.35	100.24
	kg	386.47	358.05	329.63	301.22	272.80	244.38	215.97	187.55	159.13	130.72	102.30	68.20	45.47

**Table 2.** Approximate amount of stabilizer (cyanuric acid) to obtain 40 ppm in pool

Current Cyanuric Acid Level - ppm	10,000 g (38,000 L)	12,000 g (45,425 L)	14,000 g (53,000 L)	16,000 g (60,600 L)	18,000 g (68,137 L)	20,000 g (76,000 L)	22,000 g (83,300 L)	24,000 g (90,850 L)	26,000 g (98,421 L)	28,000 g (106,000 L)	30,000 g (134,000 L)
0	3.25 (1.47 kg)	3.90 (1.77 kg)	4.55 (2.6 kg)	5.20 (2.36 kg)	5.85 (2.65 kg)	6.50 (2.94 kg)	7.15 (3.24 kg)	7.80 (3.53 kg)	8.45 (3.83 kg)	9.10 (4.12 kg)	9.75 (4.42 kg)
10	2.43 (1.10 kg)	2.92 (1.32 kg)	3.40 (1.54 kg)	3.89 (1.76 kg)	4.37 (1.98 kg)	4.86 (2.20 kg)	5.35 (2.42 kg)	5.83 (2.64 kg)	6.32 (2.86 kg)	6.80 (3.08 kg)	7.29 (3.30 kg)
20	1.62 (0.73 kg)	1.94 (0.88 kg)	2.27 (1.03 kg)	2.59 (1.17 kg)	2.92 (1.32 kg)	3.24 (1.47 kg)	3.56 (1.61 kg)	3.89 (1.76 kg)	4.21 (1.91 kg)	4.54 (2.05 kg)	4.86 (2.20 kg)

**NOTE:** The cyanuric acid reading should be maintained at 30 - 50 ppm.

## Pool Water Preparation

### Determining Pool Size (Gallons of Water in Your Pool)

- **Rectangular Pools:** Length x width x average depth x 7.5
- **Circular Pools:** Diameter x diameter x average depth x 5.9
- **Oval Pools:** Length x width x average depth x 6.7
- **Sloping Sides:** Multiply total gallons by 0.85 = gallon capacity

### Determining Pool Size (liters of water in your pool)

- **Rectangular Pools:** Length x width (meters) x average depth x 1000
- **Circular Pools:** Diameter x diameter x average depth x 785
- **Oval Pools:** Length x width (meters) x average depth x 893
- **Sloping Sides:** Multiply total liters by 0.85 = liter capacity.

 **CAUTION** - Never use dry acid (sodium bisulfate) to adjust pH in arid geographic areas with excessive evaporation and minimal dilution of pool water with fresh water. A buildup of byproducts can damage the SCG.

## Section 3

# Operating IntelliChlor SCG

This section describes the start-up procedure and operating instructions for IntelliChlor® Salt Chlorine Generator (SCG).

Before starting up and operating the SCG, the pool in which the SCG will be used must have been completed and filled with water for at least one (1) month (for plaster pools) and the pool water salt level must be stable and being maintained at 3,000 to 3,500 ppm.

### Initial Start-up Period

For the first thirty (30) days of cell operation, the self-cleaning cycle, is factory set to two (2) hours. After thirty (30) days has elapsed, the SCG will automatically set itself to four (4) hour self-cleaning cycle. This feature will clean the SCG blades more often during the initial installation, then go to a more standard self-cleaning cycle for longer blade life.

### Operation

#### Use of an external Pool Pump Timer is not required

The ICEG is designed to supply a sufficient amount of chlorine to sanitize pool water on a daily basis. If the pool pump is continuously running and the SCG is operated 24 hours a day at 100%, more chlorine would be generated than would be needed by most pools (2-4 ppm, per APSP recommendations). The SCG has its own internal timer which cycles the electrolytic cell on and off depending on what percent the Sanitizer Output is set. For instance, at 100% the cell works all the time while the pool pump is running. When set at 80%, the cell is allowed to rest 20% of the time while the pool pump is running prolonging cell life. In order to fine tune SCG to your pool size just increase or decrease the Sanitizer Output from 20% to 100% of the time. For more information, see “More and Less Output Buttons,” on page 8.

**⚠ CAUTION** - The SCG is designed only to produce chlorine. The SCG does not monitor or control chlorine levels in the pool or spa water. It is the pool owner's responsibility for monitoring and maintaining free chlorine levels at 1-3 ppm for pools and 3-5 ppm for spas. It is the pool owner's responsibility to check the free chlorine level while the pool pump is running on a regular basis, and adjust the Sanitizer Output on the SCG accordingly.

**⚠ CAUTION** - Before attempting to operate IntelliChlor refer to “General Recommendations and General Cautions,” on page 17, and “Pool Water Preparation,” on page 14. Also, do not adjust Sanitizer Output above 20% until it is certain that salt has been dissolved in pool. Operating without salt will result in the unit turning off and lighting the ADD SALT light on the salt display. No chlorine will be produced until salt is added to the pool.

#### If you use a Pool Pump Timer

The Association of Pool and Spa Professionals (APSP) recommends that all water in a residential pool pass through the filtration system at least once every twelve (12) hours (referred to as pool water turnover). However, many factors have an effect on actual pump and filter system run times. Pool size, source of water, direct sun light, indoor/outdoor, screened/unscreened, filtration system, cold or hot weather, swimmer load, rain, organic debris, algae, etc., are all factors which contribute to either more or less pool pump and filter system run times. Because of these differences, it is extremely difficult to set a standard initial run time (starting point) for the pool pump and chlorinating system.

Try initially setting the pool pump timer to twelve (12) hours. It will take a few days to achieve the correct amount of pool pump operating time. When IntelliChlor SCG is wired with a pool pump timer **results will vary greatly from one pool installation to the next, so this should be discussed with your pool professional. The key points are:**

- Operate the pool pump at least the minimum time needed for good filtration and adequate chlorine production by the SCG, according to your pool professional's recommendations.
- While pool pump timers can reduce energy consumption, the pool pump must be running for the IntelliChlor<sup>®</sup> Salt Chlorine Generator to provide chlorine and must remain running long enough to maintain proper chlorine levels (i.e., 1-3 ppm for pools and 3-5 ppm for spas of free available chlorine).

*Note: Exception - For Cold Weather Operation: The unit turns off in water temperatures of 11° C, ±1.67° C (52° F, ±3° F) and below, and will not produce chlorine. This feature extends the life of the cell.*

## Start-up Procedure (Super Chlorination)

**Super Chlorination is recommended before pool start-up.** Start out with clean, properly chlorinated, pool water from the beginning. The SCG will build up a sufficient level of chlorine for sanitation in several hours. However, if the pool water has a high demand from the start-up the SCG will not be able to produce enough chlorine to reach break-point chlorination. So, it is best to super chlorinate using an outside source at the time of pool start-up. Then, wait until the chlorine level has returned to 1-3 ppm for pools and 3-5 ppm for spas before switching on the SCG.

## Sanitizer Output Settings and Adjustments

- Switch on the pool pump switch or pool pump timer. The salt display will blink both LEDs (bottom to top) for two (2) minutes, indicating that it has not checked the salt level yet. After two (2) minutes, the salt will be checked and one (1) of the salt level LEDs will be displayed. If the salinity is below 2600 ppm, the salt display will light the red LOW SALT indicator, and the CELL light will go blank, indicating there is not enough salt in the pool for chlorine to be produced.
- Set the Sanitizer Output to 60% by pressing the **MORE** or **LESS** button (see page 8).
- After 24 hours, use a reliable test method to test the pool water for free available chlorine. The ideal range to maintain is 1-3 ppm for pools and 3-5 ppm for spas. **If the free chlorine level of the pool water is too low, increase chlorine production by pressing the MORE button. If the free chlorine level of the pool water is too high, decrease chlorine production by pressing the LESS button.**
- Due to a varying free chlorine demand of pool water, it may take a few days to determine the number of daily pool operating hours and "Sanitizer Output" percentage setting (see page 8) for your pool. Continue adjusting as necessary, allowing 24 hours between adjustments until the free chlorine level of the pool water is stabilized at 1-3 ppm for pools and 3-5 ppm for spas.

## Operating in Winter

The IntelliChlor SCG switches off and will not produce chlorine in water temperatures of 11° C, ±1.67° C (52° F, ±3° F) and below. This feature extends the life of the unit. See "Winterizing," on page 21.

## General Recommendations

- After new pool construction has been completed, before installing the IntelliChlor<sup>®</sup> Salt Chlorine Generator, install the IntelliChlor SCG “dummy cell” (P/N 520588) to remove debris from the pipes for thirty (30) days and to allow sufficient time for the pool plaster (or other similar material) to properly cure and seal.
- Read and keep this Installation and User’s Guide in a safe place.
- Increase Sanitizer Output level as necessary after heavy rain (outdoor pools) and return to normal afterwards.
- Increase Sanitizer Output level when air and water temperature rise.
- Increase Sanitizer Output level when number of pool users increase.
- Use Cyanuric Acid ONLY as necessary to stabilize chlorine in the pool water in outdoor pools. NOTE: DO NOT USE CYANURIC ACID IN INDOOR POOLS.
- Once a month take a pool water sample to a pool professional for a complete analysis.  
Add the following statements:
  - Heavy bather loads may trigger the need for additional chlorine to be added to maintain appropriate chlorine residual in the water.
  - DO NOT add pool or spa chemicals directly to the skimmer. This may damage the cell.
  - Check the expiry date of the test kit as test results may be inaccurate if used after that date.
  - When replacing the cell, only use replacement cells having a label that clearly states that it is a replacement cell for the chlorine generating device IntelliChlor Salt Chlorine Generator Model IC15REGISTRATION NUMBER 30931, PEST CONTROL PRODUCTS ACT.
  - Follow all aspects of the local and Canadian Electrical Code(s) when installing this device.
  - For proper sanitation, spas must be completely drained periodically. The number of days between COMPLETE SPA DRAINAGE is equal to the volume of spa water in litres, divided by 10 times the maximum number of daily spa users. Refill spa with water and repeat DIRECTIONS FOR USE of the device.
  - People with a medical condition should consult a physician before entering pool or spa water.
  - Maximum spa water usage temperature is 40°C. Bathing in spa water at 40°C should not exceed 15 minutes.”

## General Cautions

- Do not get fertilizer in your pool. Fertilizers contain nitrates, which cause a high chlorine demand.
- Never use dry acid to adjust pH in arid geographic areas with excessive evaporation and minimal dilution of pool water with fresh water. A buildup of byproducts can damage the SCG.
- Do not add any pool water balancing chemicals (including salt) unless the SCG is switched off.
- Do not let the Cyanuric Acid level drop below 30 ppm in outdoor pools. NOTE: DO NOT USE CYANURIC ACID IN INDOOR POOLS.

Blank Page



# Section 4

## User Maintenance

This section describes how to maintain the IntelliChlor® Salt Chlorine Generator.

### Daily service

None is needed.

1. **pH Level Test:** Test the pH level of your pool water with a reliable test method. If necessary, adjust according to your pool professional's recommendations. APSP's recommended ideal range for pH is 7.4 to 7.6, although 7.2 to 7.8 is an acceptable range under APSP's guidelines.

*Note: Never use dry acid (sodium bisulfate) to adjust pH in arid geographic areas with excessive evaporation and minimal dilution of pool water with fresh water. A buildup of byproducts can damage the SCG..*

2. **Chlorine Test:** Test the pool water the for free chlorine level with a reliable test method. Maintain ideal range by adjusting the IntelliChlor Salt Chlorine Generator Sanitize Output settings. See "More and Less Output Buttons," on page 8.

- Desired Free Chlorine is 1-3 ppm for pools and 3-5 ppm for spas.

*Note: Above 4.0 ppm of chlorine may cause excessive corrosion of metal components and possibly cause damage to associated pool equipment.*

*Note: It is recommended that free chlorine readings be taken from samples of pool water taken from two (2) places, one at the pool return line, the other well away from the pool return line. Compare the test results. A higher free chlorine level should be found at the pool return line. The higher free chlorine level at the pool return line indicates IntelliChlor Salt Chlorine Generator is producing chlorine.*

### Weekly service

1. **Total Alkalinity Test:** Test the pool water for total alkalinity with a reliable test method. Adjust according to your pool professional's recommendations. APSP's recommended ideal range for total alkalinity is 100 to 120 ppm for pools and spas.
2. **Salt Level Test:** Check salt display lights on the unit and check that the green "GOOD" light is on and is not flashing.
  - If the red LOW LED salt light is on, add salt to the pool water (see charts beginning on page 13).
  - If salt level does not rise after 24 hours, see "Troubleshooting," page 25.
3. **Calcium Hardness:** Test pool water for calcium hardness level using a reliable test method. If necessary, adjust according to your pool professional's recommendations. APSP's recommended ideal range for calcium is 200 to 300 ppm for pools and 150 -200 ppm for spas.

### Monthly Service

To ensure that the correct chemical balance is maintained in your pool, it is important to perform the following recommended salt and pool water tests every month using a reliable test method.

1. **Pool Water Sample:** Take a sample of the pool water to your local pool store for testing.

## Monthly Service (Continued)

2. **Cyanuric Acid:** Sample the pool water and test for cyanuric acid level using a reliable test method. When using the IntelliChlor SCG the recommended ideal cyanuric acid level is 30-50 ppm.
3. **Metals Test:** It is recommended that the pool water be sampled and tested periodically for the presence of metals such as copper, iron, and manganese. These metals can damage the IntelliChlor® SCG and other related pool equipment and should not be present in the pool water. If those metals are present, contact your pool professional.
4. **TDS (Total Dissolved Solids):** Test pool water for TDS level using test kit or by having a water sample tested by a pool professional. If necessary, adjust according to your pool professional's recommendations. APSP standard of 3000 minimum to 5700 - 6000 maximum ppm (which includes the salt) is recommended for salt pools.

## SCG Usage Hours Meter

The SCG provides a built-in cell "usage hours" meter that reports how many hours IntelliChlor has been operating. The SCG is designed to operate for approximately 10,000 hours before replacement is needed or roughly five (5) years of average use.

To access the system status mode:

1. Press and hold the **MORE** button for three (3) seconds until the lights scroll across the unit.
2. One (1) of the five (5) Sanitizer Output LED indicators (20%, 40%, 60%, 80% and 100%) will be lit, indicating the hours of usage. The Output LEDs are as follows:
  - 2000 hours (20% LED on)
  - 4000 hours (40% LED on)
  - 6000 hours (60% LED on)
  - 8000 hours (80% LED on)
  - 10,000 hours (100% LED on)

## Cleaning the SCG Cell Blades

**Note: Before acid washing, remove the calcium buildup in cell:** Use a garden hose on the jet setting and spray directly into both ends of the cell. Most of this calcium buildup has a slushy consistency and will be blown out of the cell. Once the majority of the calcium has been removed, continue with acid washing which will now be more effective since most of the calcium has been removed.

1. **Automatic Cleaning:** The SCG has an automatic cell blade cleaning feature (cell reversing) that helps remove scale deposits from the SCG blades. **Note:** Automatic cleaning does not interrupt chlorine production. "Scale" is a white crusty deposit that forms in excessively hard water or from pool water that is out of balance and in a scaling condition. If the SCG blades show excessive scaling, you need to perform an acid wash cleaning. Proceed to "Acid Wash Cleaning," Step 2.
2. **Acid Wash Cleaning:** If the SCG blades show a tendency to scale, it is recommended that every two (2) months the SCG be removed and inspected for scale formation and/or debris on the SCG blades. High hardness areas may require more frequent cleaning. Some filters allow debris to pass through to the SCG, possibly lodging between the blades in the SCG. A small amount of scale formation is normal. If by looking through the SCG it is observed that there is excessive scale formation between the blades or debris is present, the SCG must be cleaned as follows:
  - a. Use a high-pressure jet of water from a garden hose. If the blades cannot be reasonably cleaned in this manner, acid cleaning is necessary.

## Cleaning the SCG Blades (Continued)

- b. **To acid clean the SCG blades:** Disconnect the AC power from the Power Center. Disconnect the IntelliChlor<sup>®</sup> Salt Chlorine Generator cell communication cable from the Power Center.
- c. Mix 0.95 litres (one (1) quart) of muriatic acid with 3.79 litres (one (1) gallon) of tap water in a plastic bucket.

 <b>WARNING</b>
<p>Working with muriatic acid can be dangerous. When cleaning the SCG always wear rubber gloves and eye protection. Always add acid to water, do not add water to acid. Always work in a well-ventilated area. Splashing or spilling acid can cause severe personal injury and/or property damage.</p>

*Note: The IntelliChlor SCG acid cleaning kit (P/N 520670) provides a cap for the SCG to allow diluted acid solution to be poured into the SCG to immerse the blades for cleaning.*

- d. Screw the cap with washer and o-ring onto the threaded end of the IntelliChlor SCG cell (*the cap, o-ring and washer are provided with the cleaning kit*). Place the SCG vertically in a 18.9L (five (5) gallon) bucket. Pour the acid solution (as described in step c) into the SCG until the cell blades and salinity probes are just covered. Allow the acid solution to bubble, and to clean the blades. *Note: The acid should only be contained inside the SCG covering the blades. Try not to spill the acid on the outside of the SCG. If acid does spill on the outside of the SCG, wash it off with water.* A foaming action will begin, which is caused by scale (calcium carbonate) being dissolved from the blades. If rigorous foaming action does not begin, the blades do not need to be cleaned (**STOP THE CLEANING PROCESS - go on to step “e”**). **Otherwise, allow the blades to remain immersed in the solution until the foaming has stopped. However, do not leave acid in the SCG for more than thirty (30) minutes. Excessive acid washing will damage the blades.**
- e. Remove the SCG from the bucket and place in an empty 18.9L (five (5) gallon) bucket. Rinse the inside and outside of the SCG thoroughly with clean tap water and inspect. If deposits are still visible, repeat the acid cleaning process.
- f. Rinse the SCG again with clean tap water and inspect. Once clean, replace the SCG and resume normal operation.
- g. If the acid wash procedure is necessary, it is recommended that a sample of pool water be analyzed by a pool professional for excessive calcium hardness (i.e. ideal range is 200 to 300 ppm for pools and 150 -200 ppm for spas.) and/or improper water balance.
- h. **Inspect the inside of the SCG every two (2) months (or more frequent in hard water areas).** If no scale or debris deposits are observed inside the SCG after four (4) months, it is not necessary to continue inspections every two (2) months. However, due to possible changes in pool water chemistry and filtering effectiveness, it is recommended that the cell be removed for inspection at least twice a year.
- i. Reconnect the SCG communication cable plug in the Power Center, then reconnect AC power to the IntelliChlor SCG Power Center.

## Winterizing

Very little chlorine production is needed in cold water so long as free chlorine levels are maintained at 1-3 ppm for pools and 3-5 ppm for spas. The IntelliChlor SCG will not produce chlorine below 11° C, ±1.67° C (52° F ±3° F). This low-temperature cutoff extends the life of the cell. If preventative measures are not taken, freezing water may cause severe damage to the cell. Prevent freeze damage to the cell by running the pool pump continuously or winterize the pool by draining water from pump, filter, and all intake and return lines. Remove the cell, clean and store it.

Blank Page

# Section 5

## Installation

This section describes how to install the IntelliChlor® Salt Chlorine Generator into the pool plumbing system. Also, included are connection instructions for IntelliTouch®, EasyTouch® and SunTouch® Control Systems. Before installing, review the IntelliChlor SCG kit contents and required tools.

**Note:** For Power Center installation instructions, see the “IntelliChlor Power Center Installation Guide” (P/N 520590).

**Note:** Salt is not provided. For details about the type of salt to use, see “What Type of Salt to Use,” on page 11.

### Kit Contents

- One IntelliChlor Salt Chlorine Generator
- Two (2) cell union with two (2) o-rings
- Installation and User’s Guide (this manual)

### Required Tools

- Tape measure
- Phillips and flathead screwdriver
- Pliers
- Hacksaw
- An NSF® approved all purpose PVC/CPVC/ABS cleaner primer
- An NSF® approved all purpose PVC/CPVC/ABS cement

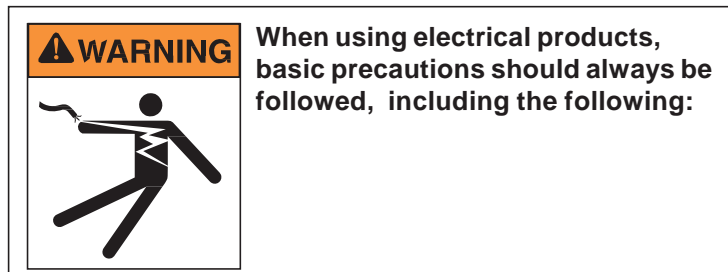

- **DANGER: RISK OF ELECTRIC SHOCK, WHICH CAN RESULT IN SERIOUS INJURY OR DEATH.** Before attempting installation of service, ensure that all power to the circuit supplying power to the system is disconnected/turned off at the circuit breaker. It is recommended, but not mandatory that the IntelliChlor Power Center be connected to a circuit protected by a ground fault circuit-interrupter (GFCI).
- Grounding (earth bonding) is required. The unit should be installed by a qualified service person and grounded.
- Install to allow access to cell buttons and power center.
- **Read Safety Precautions and Important Instructions (page ii and iii). Before attempting any electrical wiring, be sure to read and follow Safety Instructions. Wiring should only be performed by a qualified professional.**
- Install the IntelliChlor SCG unit a minimum of 1m (3 ft) away from the heater outlet.
- Pipe couplings: Schedule 80, maximum pressure 517kPa (75 psi) at 21° C (70° F).
- **Note:** Operate unit with minimum flow of 94 Lpm (25 gpm). For high flow applications, use a bypass loop (see page 4) for best flow sensing.
- **Note:** Provide at least 30-45 cm (12"-18") of straight pipe in front of the cell inlet.

## IntelliChlor® SCG “Dummy” Cell

After new pool construction has been completed, in order to prevent debris from entering the IntelliChlor Salt Chlorine Generator, it is recommended that the IntelliChlor® Salt Chlorine Generator “dummy” cell (P/N 520588) be installed before installing the IntelliChlor Salt Chlorine Generator. After the pool system has flushed the debris from the pipes, remove the “dummy cell” and install the IntelliChlor Salt Chlorine Generator.

## Selecting Model Size

### IntelliChlor SCG (Model IC15)

**Chlorine Production:** The equivalent of 0.278 kg of pure chlorine per 24 hour period of pool pump run time.

**Residential Pools:** One unit per 56,800 L (15,000 Gal), Residential Spas: One unit per 55 600 L (14,688 Gal).

## Installing the IntelliChlor SCG Cell

Install the IntelliChlor cell assembly no closer than 1 metre (three (3) feet) away from the heater outlet, if used. For more information see plumbing diagrams on page 4 and 5.

*Note: For best flow sensing, provide at least 30-45 cm (12"-18") of straight pipe in front of the cell inlet.*

*Note: After new pool construction has been completed, in order to prevent debris from entering the IntelliChlor cell assembly, it is recommended that the IntelliChlor pass-through cell (P/N 520588) be installed before installing the IntelliChlor cell. After the pool system has flushed the debris from the pipes, remove the pass-through cell and install the IntelliChlor cell.*

*Note: Pipe couplings: Schedule 80, maximum pressure 517 kPa (75psi) at 21° C (70°F).*

To install the IntelliChlor cell:

1. Using PVC glue, mount the PVC couplings to the plumbing pipe. Allow the glue to dry.
2. Mount the cell to allow access to the control panel. Install the cell onto the couplings. Ensure the O-rings are seated properly.
3. Switch on the pump and visually inspect for leaks around the couplings.

## Connecting the IC15 Cell Power Cable to the Power Center

**⚠ WARNING** - Switch OFF main system power to the Power Center before making any connections.

**Be sure that AC power is switched OFF before connecting the power cord to the Power Center.**

After the IC15 cell installation is completed, connect the cell power cable to the Power Supply:

- Align the four (4) pins of the cell power cord connector with the socket on the side of the Power Supply and insert the connector. Turn the round socket nut until it locks the connector in place.

Power Supply connector



IC15 Power Center

# Section 6

## Troubleshooting

Use the following troubleshooting information to resolve possible problems with the IntelliChlor® SCG.

**Note:** *Switch power off to unit before to attempting service or repair. Always remove AC power to the IntelliChlor SCG IC15 Power Center.*

**Table 1: Troubleshooting**

Problem	Possible Cause	Corrective Action
Low or no chlorine.	Low stabilizer (cyanuric acid) level in pool water (outdoor pools only).	Add cyanuric acid in outdoor pools only to maintain 30 - 50 PPM per pool professional's recommendations. See Stabilizer Chart, Table 2, page 14.
	Insufficient operating hours of the SCG.	Increase the SCG operating time per day. See page 15 for pump run time information.
	SANITIZER OUTPUT percentage set too low or off at 0%.	Increase SANITIZER OUTPUT by pressing the MORE button. See page 8.
	Recent increases in weather temperature without increasing the SCG Sanitizer Output.	Increase SANITIZER OUTPUT by pressing the MORE button. See page 8.
	Temporary loss of chlorine due to heavy organic load, rain, leaves, fertilizer or heavy bather load, recent party, or pets using pool.	Set "Boost" mode and allow to run for 24 hours. Recheck, If still too low, super-chlorinate by using an outside source. (Take pool water sample to pool professional).
	Low (less than 2600 ppm) salt level in pool water, shuts off chlorine production.	Observe Salt Display lights. See "Salt Level Status LEDs," page 7.
	High nitrate and phosphate level.	Contact Pool Professional.
	Metals present in pool water.	Contact Pool Professional.
	New pool water, or not shocked properly upon startup.	Super Chlorinate Pool. See "Start-up Procedure (Super Chlorination)", page 16.
	Clogged or dirty cell.	Remove cell for inspection. Clean if necessary. (see page 20).

**Table 1: Troubleshooting (Continued)**

<b>Problem</b>	<b>Possible Cause</b>	<b>Corrective Action</b>
Red LOW salt LED is on.	Pool water needs salt. No chlorine is being produced.	Add salt as described on pages 13, 14.
Red LOW SALT light on and green CELL light flashing	Salt level in pool water is low and may need inspecting.	Check salt level, add if necessary to GOOD level. Allow 24 hours for salt to mix in water. If CELL light is still flashing after 24 hours, remove and inspect cell and clean if necessary.
Red CHECK SALT light is on	Not enough salt in pool. Heavy Rainfall. Leak in pool.	Add salt to pool to achieve 3400 ppm. See page 13, 14.
Green GOOD salt light is flashing	Too much salt in pool. May cause damage to pool related equipment and surrounding surfaces.	Dilute pool water by draining some water, then filling with fresh water
COLD WATER light is red.	Water is below 52°F.	The water temperature must be above 52°F to produce chlorine.
CELL light does not come on.	Chlorine Production set to 00%.	Adjust CHLORINE PRODUCTION to desired percentage.
	Insufficient water flow. Cell is plugged with debris, pump has lost prime.	Remove obstruction and/or clean cell. See page 10. Prime pump if necessary.
	Salt level below 2600 ppm.	Add salt as described on pages 13, 14, and 15.
CELL light is flashing green.	Check salt level	Add salt if necessary to maintain 3400 ppm minimum.
	Cell has calcium build-up and requires cleaning.	Refer to Maintenance Procedure for acid wash/cleaning. See "User Maintenance," on page 9.
	Check water chemistry and balance. NOTE metal content should be 0 ppm.	Remove metals from water using chemical solution.
Flow light is red.	Pump fails to provide sufficient water flow.	Check for correct operation of the pump, i.e., loss of pump prime or clogged strainer baskets.
	Closed valves.	Check and correct all valve alignments.
	Dirty filter.	Follow filter cleaning procedures.
	Obstruction in the Chlorinator cell.	Remove cell for inspection. Follow cleaning procedures. See "Electrolytic Cell Cleaning," on page 20.
IntelliChlor unit does not have power.	Fuse in Power Center is open.	Replace AC fuse, located at bottom of Power Center.
	No AC power to Power Center.	Verify time clock is providing 110 VAC or 220 VAC to Power Center when active.
	Transformer leads not wired correctly in Power Center.	Verify transformer leads wired to AC source by referring to wiring diagram decal on inside of Power Center cover.



# IntelliChlor® SCG Model IC15 System Specifications and Wiring

**Circuit Protection:** Two-pole 20 AMP device at the electrical panel.

## IntelliChlor SCG (Model IC15)

**Input:** 85-130 VAC, 50/60 Hz, 65 watts

**Output:** 24 VAC (4 AMPS) to internal blades of cell. Chlorine: 0.278 g/24 hours

**Water flow:** 95 liters per minute (25 gallons per minute) minimum. 397 liters per minute (105 gallons per minute) maximum. Maximum pressure: 517 kPa (75 psi).

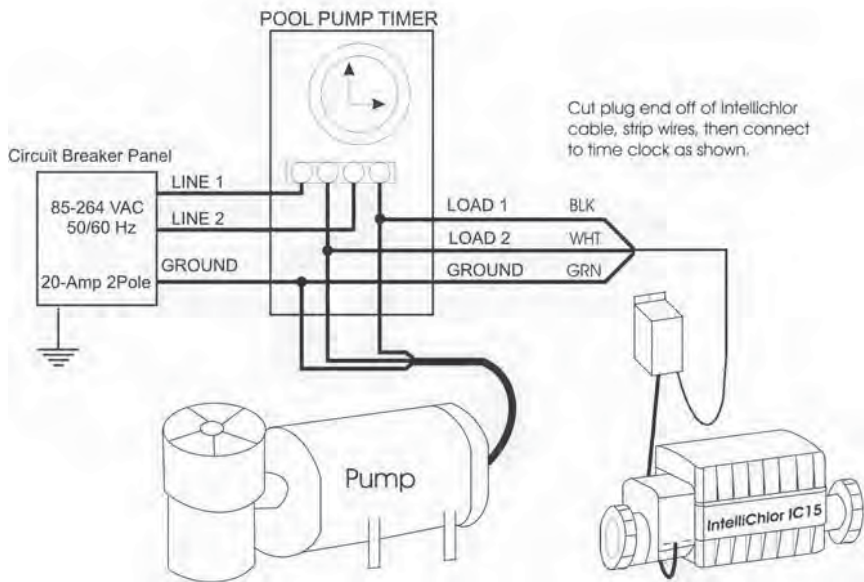

## 110 VAC Basic System Wiring with Pool Pump Timer

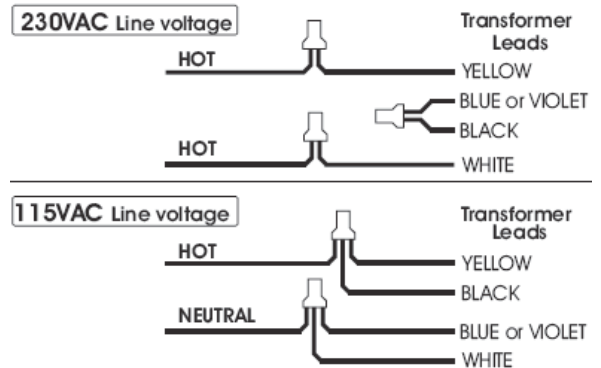
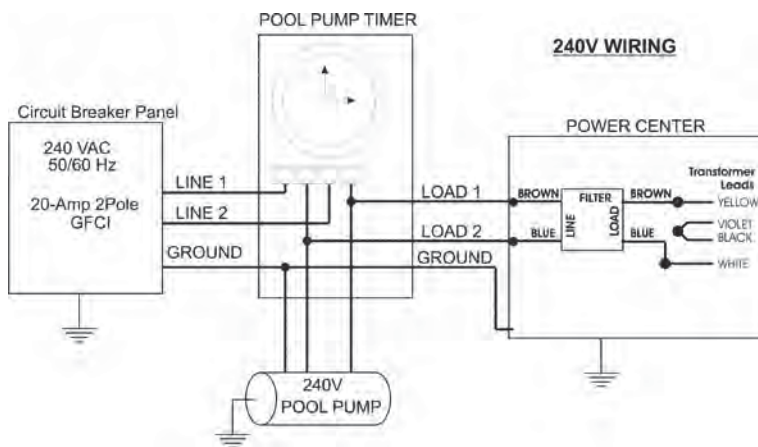

## 240 VAC Basic System Wiring with Pool Pump Timer

## LIMITED WARRANTY

Pentair Aquatic Systems ("Pentair") warrants the IntelliChlor® Salt Chlorine Generator (SCG) as follows:

**SCG Cell Limited Warranty:** Pentair warrants the SCG to be free from defects in material and/or workmanship for a period of one (1) year from the original date of installation.

**SCG Power Supply Limited Warranty:** Pentair warrants the SCG Power Center to be free from defects in material and/or workmanship for a period of one (1) year (parts only) from the original date of installation.

*Exceptions that shall result in Pentair's denial of a warranty claim:*

1. Damage caused by careless handling, improper repackaging, or shipping.
  2. Damage due to misapplication, misuse, abuse or failure to operate equipment as specified in the SCG Installation and User's Guide.
  3. Damage caused by failure to install products as specified in the SCG Installation and User's Guide.
  4. Damage due to unauthorized product modifications or alterations, or failure to use Pentair original replacement parts.
  5. Damage caused by negligence, or failure to properly maintain products as specified in the SCG Installation and User's Guide.
  6. Damage caused by failure to maintain water chemistry in conformity with the standards set forth in the SCG Installation and User's Guide.
  7. Damage caused by water scaling, freezing or any conditions causing inadequate water circulation.
  8. Accidental damage, fire, acts of God, or other circumstances outside the control of Pentair.
- This warranty extends to the original retail owner (Customer) only, beginning on the date of installation and is not enforceable by any other party. Proof of purchase and/or date of installation will be required for all warranty claims. Customer agrees to pay all shipping charges to Pentair.
  - Warranties by others: Some products incorporate components manufactured by other manufacturers. Some of these provide warranties in addition to the warranty provided herein. In all such cases a copy of that warranty will be provided with the product. To the extent protection provided under any such third party warranty exceeds the Limited Warranty provided herein, the Customer must look only to that other manufacturer for the additional warranty protection.

**Warranty Obligations of Pentair Water Pool and Spa, Inc.:** Should a defect in workmanship and/or material in any item covered by this warranty become evident during the term of the warranty, then upon the Customer following the procedures set forth below, Pentair will, at its option, repair or replace such item or part at its own cost and expense. Pentair's maximum obligation under this warranty is limited to the repair and replacement of the SCG. Pentair disclaims all other expressed or implied warranty obligations.

Pentair is not, however, responsible under this warranty for any cost of shipping or transportation of the equipment or parts thereof to or from Pentair's Technical Service Department. Also, Pentair is not liable for any loss of time, inconvenience, incidental expenses such as telephone calls, labor or material charges incurred in connection with the removal or replacement of the equipment, or any other incidental or consequential damages, including but not limited to damage to pool equipment or any surface in or around the pool in which the SCG is installed.

PLEASE NOTE: Some provinces do not allow the exclusion or limitation of incidental, or consequential damages, so the above limitation or exclusion may not apply to you.

**No Other Warranties:** TO THE MAXIMUM EXTENT PERMITTED BY APPLICABLE LAW, PENTAIR DISCLAIMS ALL OTHER WARRANTIES, WHETHER EXPRESS OR IMPLIED, INCLUDING BUT NOT LIMITED TO THE IMPLIED WARRANTIES OF MERCHANTABILITY AND FITNESS FOR A PARTICULAR PURPOSE.

*Continued on next page.*

### LIMITED WARRANTY (Continued)

**Procedure for Obtaining Performance:** In order to obtain the benefits of this warranty, the Customer who made the original retail purchase must contact the Pentair Technical Service Department upon discovery of the defect, but in no event later than the expiration date of the warranty period provided in this warranty. Upon receipt of this communication, Pentair will promptly notify the Customer of the address to which the defective item may be shipped. The Customer shall then ship the item, freight prepaid, to the address indicated, together with a "RETURN GOODS AUTHORIZATION" form obtained from Pentair's Technical Service and a brief description of the problems encountered. Unauthorized returns will not be accepted. Freight must be prepaid by customer.

**Warranties or Representations by Others:** No dealer or other third party entity has any authority to make any warranties or representations concerning Pentair or its products. Accordingly, Pentair is not responsible for any such warranties or representations.

**Other Rights:** This warranty gives you specific legal rights and you may also have other rights, which vary from state to state. This warranty supersedes all previous publications.

PENTAIR WATER POOL AND SPA, INC.

1620 Hawkins Ave. Sanford, NC 27330 - 10951 W. Los Angeles Ave. Moorpark, CA 93021 - Phone 800-831-7133  
- Fax 800-284-4151

 **WARNING:** Salt is an inherently corrosive material. While the levels of salt required for proper operation of the IntelliChlor® Salt Chlorine Generator are relatively low when compared to sea water and other salt solutions, placing any amount of salt in your pool increases the likelihood of corrosion or other deterioration of pool equipment and any surfaces used in and around your pool. Metal parts (including steel pools) and certain natural and man-made surfaces are particularly susceptible to corrosion and deterioration when used in and around salt water pools. Pentair Aquatic Systems does not represent or otherwise guarantee that the proper use of the IntelliChlor Salt Chlorine Generator will prevent corrosion or other deterioration of pool equipment and any surfaces used in and around your pool. Consult your experienced pool professional, who should be able to advise you on the proper material selection, installation techniques for those materials, and the proper use, care and maintenance of those materials for your specific pool type and location in order to minimize the corrosion and deterioration that is inherent in and around salt water pools.



1620 HAWKINS AVE., SANFORD, NC 27330 - (919) 566-8000  
10951 WEST LOS ANGELES AVE., MOORPARK, CA 93021 • (805) 553-5000  
WWW.PENTAIRPOOL.COM

All Pentair trademarks and logos are owned by Pentair or one of its global affiliate. Pentair Aquatic Systems™, IntelliChlor®, EasyTouch®, IntelliTouch®, SunTouch®, Rainbow™ and Eco Select® are trademarks and/or registered trademarks of Pentair Water Pool and Spa, Inc. and/or its affiliated companies in the United States and/ or other countries. Unless expressly noted, names and brands of third parties that may be used in this document are not used to indicate an affiliation or endorsement between the owners of these names and brands and Pentair Water Pool and Spa, Inc. Those names and brands may be the trademarks or registered trademarks of those third parties. Because we are continuously improving our products and services, Pentair reserves the right to change specifications without prior notice. Pentair is an equal opportunity employer.

© 2017 Pentair Water Pool and Spa, Inc. All rights reserved. This document is subject to change without notice.

P/N 522333 REV. C 6/2017