

AquaCal®

HEATWAVE SUPERQUIET®



Installation Manual

Five Button Display v2.xxx (HP9 control board)

Important

Read this document before operating / installing this product

For additional product manuals and operation / installation procedures, please visit www.AquaCal.com



MODEL / SERIAL NUMBER

Table of Contents

Contacting AquaCal AutoPilot, Inc.	1
Safety	1
1 - Installation	4
1.1 Positioning Equipment	5
1.2 Plumbing	7
1.2.A Plumbing Requirements	7
1.2.B Plumbing Diagrams	7
1.2.C Maintaining Ability to Winterize	11
1.2.D Water Connections to Heat Pump	11
1.2.E In-Line Chlorine Feeders	12
1.2.F Water Flow Rates	12
1.3 Electrical	13
1.3.A Electrical Requirements	14
1.3.B Incoming Power Access Holes	16
1.3.C Access Panels	17
1.3.D Verifying Transformer Setting (Select Units)	18
1.3.E Schematic Location	19
1.4 Connecting Circulation Pumps (Optional)	19
1.4.A Connections	19
1.4.B Manually Configure a Circulation Pump	21
1.4.C Deleting Equipment	22
1.5 Connecting an External Controller (Optional)	23
1.5.A PoolSync®	24
1.5.B FS2 (Pool-Spa)	25
1.5.C SMART Controllers	26
1.5.D 2-wire Controllers (Pool-Spa)	30
1.5.E 3-wire Controllers (Pool-Off-Spa)	32
1.6 Connecting and Configuring a Solar Control System (Optional)	33
1.6.A Connecting a Solar Control Actuator	33
1.6.B Connecting a Solar Control (Roof) Temperature Sensor	34
1.6.C Install Water Temperature Sensors for Solar Systems	35
1.6.D Configuring Solar Control (Select Units)	36
D.1 Activating Solar Control Feature	37
D.2 Manually Configure (Add) Solar Controller	38
D.3 Solar Controller Group Setup	39
D.4 Solar Control Mode	40
D.4.a Set Solar Control to ECO Mode	40
D.4.b Set Solar Control to HYBRID Mode	41
D.4.c Set Solar Control to SOLAR OFF	41

D.5 Set a desired temperature (setpoint) for the solar system to activate (Select Units)	42
D.6 Heat Pump Mode (Hybrid or OFF Only)	43
D.7 Solar Boost (ECO Mode Only)	43
D.8 Adjusting Solar Heating Differential	44
D.9 Adjusting Solar Cooling Differential	46
D.10 Solar Override	47
D.11 Viewing Solar Roof Temperature	48
D.12 Solar Heat / Cool Mode	49
1.7 Connecting Multiple Heat Pumps (Optional)	50
1.7.A Connecting Heat Pumps	50
1.7.B Configure Primary Heat Pump	51
1.7.C Configure Secondary Heat Pumps	52
1.8 Programming	53
1.8.A Setting Date and Time	54
1.8.B Setting Date and Time Format	54
1.8.C Selecting Celsius or Fahrenheit	55
1.8.D Set a desired temperature (setpoint) for the solar system to activate (Select Units)	56
1.8.E Set a desired temperature (setpoint) for the Heat Pump to activate	57
1.8.F Setting Entry Code Option	58
1.8.G Disabling Entry Code Option	59
1.8.H Site Configuration Presets (Optional)	60
1.8.I Configuring Groups	65
I.1 Create a Group	66
I.2 Edit a Group	67
I.3 Delete a Group	68
1.8.J Configuring Schedules	69
J.1 Create a Schedule	69
J.2 Edit a Schedule	71
J.3 Delete a Schedule	72
1.8.K Schedule and Program Modes	73
1.8.L Using Shortcuts	78

2 - Appendix	81
2.1 Adjusting Water Flow Using ΔT (Delta-T)	81
2.2 Adjusting Water Pressure Switch (Select Units)	82
2.3 Configure Variable Speed Compressors (Select Units)	83
2.4 Clearances	87
2.5 Cleaning Equipment After Installation	87
2.6 Dimensions	89
2.7 Equipment Parameters	90
2.8 Factory Reset	91
2.9 Freeze Protection	92
2.10 FS2 Turbo Boost Enable (Select Units)	94
2.11 Identifying Model Specifications	95
2.12 Menu Trees	97
2.13 Three-Phase Adjustment	99
2.14 Viewing System Information	99
2.15 Weights	100
2.16 RPM Adjustments	101
2.17 Saving Installer Settings to USB	103
2.18 Initial Heating Recommendations	104
2.19 Initial Cooling Recommendations	104
2.20 Service Mode	105
2.21 Winterizing	106
2.22 Available Accessories	107
3 - Troubleshooting	110
3.1 Fault Codes	111
3.2 Issues and Resolutions	117

Contacting AquaCal AutoPilot, Inc.

For further assistance, please contact the distributor or installer of this product.

If unavailable, please contact AquaCal® for a partner in your area. To better assist you, please have the heat pump model and serial number available.

Product Information:	
Website	www.AquaCal.com
Phone	(1) 727-823-5642
Hours	8-5 pm, Eastern M-F
Service Information:	
Website	www.AquaCal.com/request-heat-pump-service/

SAFETY

- For personal safety, and to avoid damage to equipment, follow all safety instructions displayed on the equipment and within this manual. Repair and service of heat pump must be performed by an authorized service center.
 - Warranties may be voided if the equipment has been improperly installed, maintained or serviced.
 -
- If the issue persists, please contact the installing dealer for service.

SAFETY SIGNALS

Throughout this document, safety signals have been placed where particular attention is required.

 **DANGER**

Failure to heed the following will result in injury or death.

 **WARNING**

Failure to heed the following may result in injury or death.

 **NOTICE**

Failure to heed the following may result in damage to equipment.

When installing and using your heat pump basic safety precautions must always be followed, including the following:

 **DANGER**

Failure to heed the following will result in injury or death.

- The heat pump utilizes high voltage and rotating equipment. Use caution when servicing.
- RISK OF ELECTRICAL SHOCK FROM ENERGY STORED IN CAPACITORS - MODELS EQUIPPED WITH VARIABLE FREQUENCY COMPRESSOR DRIVES STORE ELECTRICITY EVEN AFTER THE POWER HAS BEEN DEACTIVATED AT THE POWER BREAKER. ***Wait for 2 minutes after the shut down of equipment before servicing.***
- Follow all National Electric Codes (NEC) and / or State and Local guidelines.



WARNING

Failure to heed the following may result in injury or death.

- Installation and repairs must be performed by a qualified technician.
- The Heat Pump contains refrigerant under pressure. Repairs to the refrigerant circuit must not be attempted by untrained and / or unqualified individuals. Service must be performed only by qualified HVAC technicians. Recover refrigerant before opening the system.
- Improper water chemistry can present a serious health hazard. To avoid possible hazards, maintain pool / spa water per standards as detailed in the product's operation manual.
- Sudden or prolonged immersion in water warmer than normal body temperature may cause a condition known as Hyperthermia and related injuries.
 - Hyperthermia occurs when the internal temperature of the body reaches a level several degrees higher than the normal body temperature of 98.6° F (37° C).
 - The symptoms of Hyperthermia include, but are not limited to, a failure to perceive heat, slurred speech or mumbling, slow, shallow breathing, weak pulse, clumsiness, drowsiness or low energy level, confusion, poor decision-making, lack of concern about personal welfare; progressive loss of consciousness resulting in danger of drowning.
 - The effects of Hyperthermia include failure of the nervous system, respiratory system and heart; failure to recognize the need to exit spa; unawareness of impending hazard; physical inability to exit the spa; progressive loss of consciousness resulting in danger of drowning.
 - Persons having an adverse medical history. or pregnant women, should consult a physician before immersing in a warm body of water. Children and the elderly should be supervised by a responsible adult.
 - When pregnant, soaking in warm water for long periods of time can harm the fetus.
 - The use of alcohol, drugs, or medication can greatly increase the risk of fatal Hyperthermia.
 - Exit immediately if uncomfortable, dizzy, or sleepy.
- Sudden or prolonged immersion in water colder than normal body temperature may cause a condition known as Hypothermia and related injuries.
 - Hypothermia occurs when the internal temperature of the body reaches a level several degrees below the normal body temperature of 98.6° F (37° C).
 - The symptoms of Hypothermia include, but are not limited to, shivering (although as hypothermia worsens, shivering stops), slurred speech or mumbling, slow, shallow breathing, weak pulse, clumsiness, drowsiness or low energy level, confusion, poor decision-making, lack of concern about personal welfare, unconsciousness, and bright red, cold skin (in infants).
 - The effects of Hypothermia include failure of the nervous system, respiratory system and heart; failure to recognize the need to exit spa or cold plunge; unawareness of impending hazard; fetal damage in pregnant women; physical inability to exit the spa or cold tub; progressive loss of consciousness resulting in danger of drowning.
 - Persons having an adverse medical history. or pregnant women, should consult a physician before immersing in a cold body of water. Children and the elderly should be supervised by a responsible adult.
 - When pregnant, soaking in cold water for long periods of time can harm the fetus.
 - The use of alcohol, drugs, or medication can greatly increase the risk of fatal Hypothermia.
 - Exit immediately if uncomfortable, dizzy, shivering, or sleepy.
- This appliance is not to be used by persons (including children) with reduced physical, sensory, or mental capabilities, or lack of experience and knowledge, unless they have been given supervision or instruction.
- Children must be supervised and are not to play with the appliance.
- The information contained in this section is intended for use by qualified electricians familiar with electrical Service-industry safety standards and methods.
- Locate the equipment disconnect as near to the heat pump as possible. Always satisfy applicable codes and standards.
- Never mount power-disconnects directly to the heat pump.
- In sizing power wiring, be especially aware of up-sizing requirements necessary due to wiring distances. Always satisfy applicable codes and standards.

- AquaCal AutoPilot, Inc. heat pumps are designed to use copper conductors, only. Do not use aluminum wire.
- If multiple heat pumps are on-site, confirm that the multiple heat pump configuration has been utilized. This will prevent multiple heat pumps attempting to start at the same time, causing an excessive power drop at start-up.
- Multiple heat pumps installed at the same site may benefit from automatic sequencing controllers (ASC) to avoid excessive power draws at start-up.

NOTICE

Failure to heed the following may result in damage to equipment.

- Maintain proper water chemistry to avoid damage to the pump, filter, pool shell, etc.
- Water flow exceeding the maximum flow rate requires a bypass. Damage due to excessive water flow will void the warranty.
- Failure to protect equipment against corrosive conditions will adversely affect the life of the equipment and will void equipment warranty.

SAVE THESE INSTRUCTIONS

1 - Installation

DANGER

Failure to heed the following will result in injury or death.

- Deactivate power while routing wiring to control board.
- RISK OF ELECTRICAL SHOCK FROM ENERGY STORED IN CAPACITORS - MODELS EQUIPPED WITH VARIABLE FREQUENCY COMPRESSOR DRIVES STORE ELECTRICITY EVEN AFTER THE POWER HAS BEEN DEACTIVATED AT THE POWER BREAKER. *Wait for 2 minutes after the shut down of equipment before servicing.*
- Follow all National Electric Codes (NEC) and/or State and Local guidelines.

WARNING

Failure to heed the following may result in injury or death.

- Installation of this equipment by anyone other than a qualified installer can result in a safety hazard.
- The information contained throughout the "Installation" section is intended for use by qualified installation technicians familiar with the swimming Pool/Spa safety standards.

NOTICE

Failure to heed the following may result in damage to equipment.

- Failure to protect equipment against corrosive conditions will adversely affect the life of the equipment and will void equipment warranty.
- Do not install equipment inside of a building.

IN THIS SECTION:

1.1 Positioning Equipment	5
1.2 Plumbing	7
1.3 Electrical	13
1.4 Connecting Circulation Pumps (Optional)	19
1.5 Connecting an External Controller (Optional)	23
1.6 Connecting and Configuring a Solar Control System (Optional)	33
1.7 Connecting Multiple Heat Pumps (Optional)	50
1.8 Programming	53

1.1 Positioning Equipment

NOTICE

Failure to heed the following may result in damage to equipment.

- Do not install equipment inside of a building.

Outdoor Use Only

Do not install equipment inside of a room or building.

- Heat Pumps require unobstructed airflow for proper operation. Heat Pumps should never be installed indoors or in a location where airflow is restricted.
- If an indoor installation is being considered, the installer and dealer are strongly urged to contact the AquaCal Application Department, or a local Professional Engineer prior to proceeding.
- See "*Clearances*" on page 87.

Controlling Irrigation and Rainwater Runoff

- Irrigation water may damage heat pump components. Direct irrigation water away from the heat pump.
- The heat pump will withstand normal rainfall. Do not allow a roof slope to direct rainwater onto the heat pump. Have a gutter installed on the roof edge to direct this water away from the heat pump. Or install the heat pump in another location.
- Prevent installations in corrosive conditions that will adversely affect the life of the equipment and void equipment warranty.

Planning for Condensation

The heat pump can produce a large amount of condensation. The amount of water depends on air temperature and humidity.

- Install the heat pump with enough height to allow for water drainage.
- Plan for water drainage as needed.
 - See "*Condensation Drain Kit (# STK0202)*" on page 107.

Mounting Pad Requirements

- The heat pump's base must be installed on a flat and level surface that completely supports the entire base.
- Build the heat pump pad out of concrete or other code-approved material.
- Confirm the pad can support the weight of the heat pump.
- Elevate the pad enough to allow for drainage.
- Make sure the pad is flat and level.
- Have the pad support the entire heat pump base in all directions.
- Do not install the heat pump on soil or grass.
- Do not allow the heat pump base to touch the building's foundation.
- Do not place the heat pump directly on a concrete floor. This can cause noise to be transmitted to an occupied space. If necessary install vibration dampers between the heat pump base and floor.
- Equipment pad must meet all requirements of authorities having code-related jurisdiction.

Anchoring to Pad

- Follow all applicable local, state, and national requirements regarding wind load anchoring.
- The shipping brackets used to secure the heat pump to the pallet are approved mounting (hurricane) brackets. They should be used to anchor the heat pump to the pad.
- If needed, contact AquaCal® to obtain anchoring kit information. Please have the heat pump model number and serial number when requesting support.

1.2 Plumbing

1.2.A Plumbing Requirements

- The heat pump must receive water flow under worst-case conditions such as a fouled water filter.
- Failure to provide clean filtered water to the heat pump can void the product warranty.
- Water flow exceeding maximum flow rates will negatively affect the total pool filtration performance and may damage the heat pump. This will not be covered under the equipment warranty. See "*Water Flow Rates*" on page 12.
 - Install a bypass valve whenever water-flow may exceed the maximum rating.
 - See "*Bypass Valve Kit (# STK0135)*" on page 107.
 - For additional guidance testing water flow rates, please contact AquaCal®.

1.2.B Plumbing Diagrams

Plumbing diagrams are provided in this section as a planning guide to the sequence of equipment, valves, and fittings.

- The basic plumbing configurations for typical installations are shown.
- If the installation does not closely follow any of the supplied plumbing diagrams, AquaCal® Technical Support is available for installation advice and guidance.
- Confirm water provided to the heat pump is clean and filtered.

Heat Pump with water flows equal or less than the maximum listed flow rate

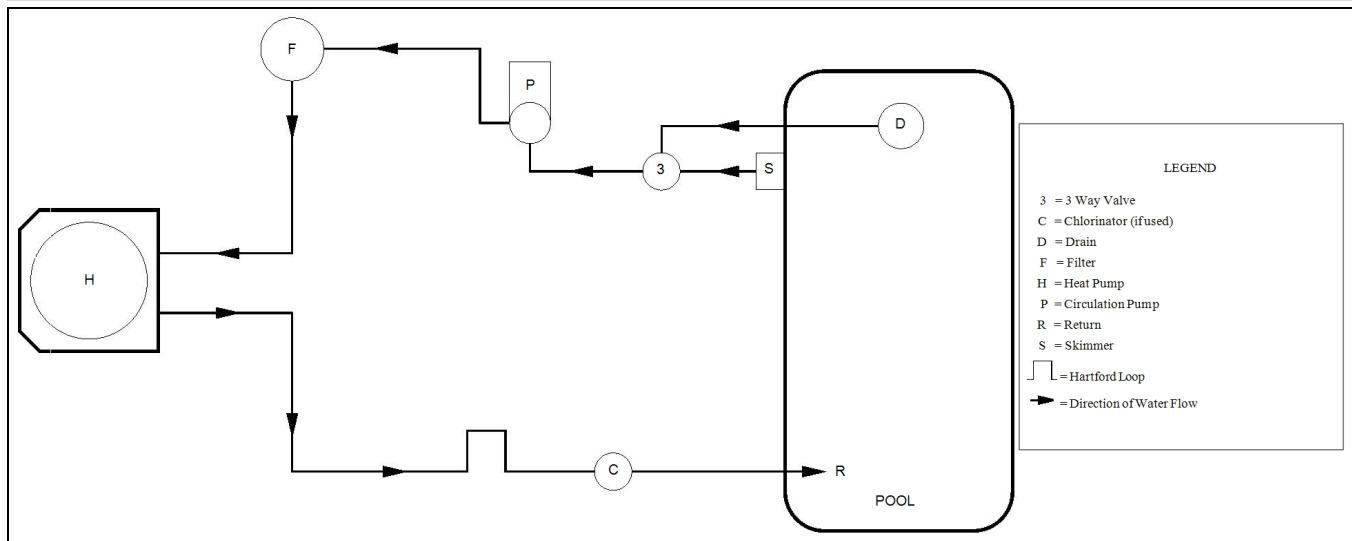

Heat Pump with water flows greater than the maximum listed flow rate

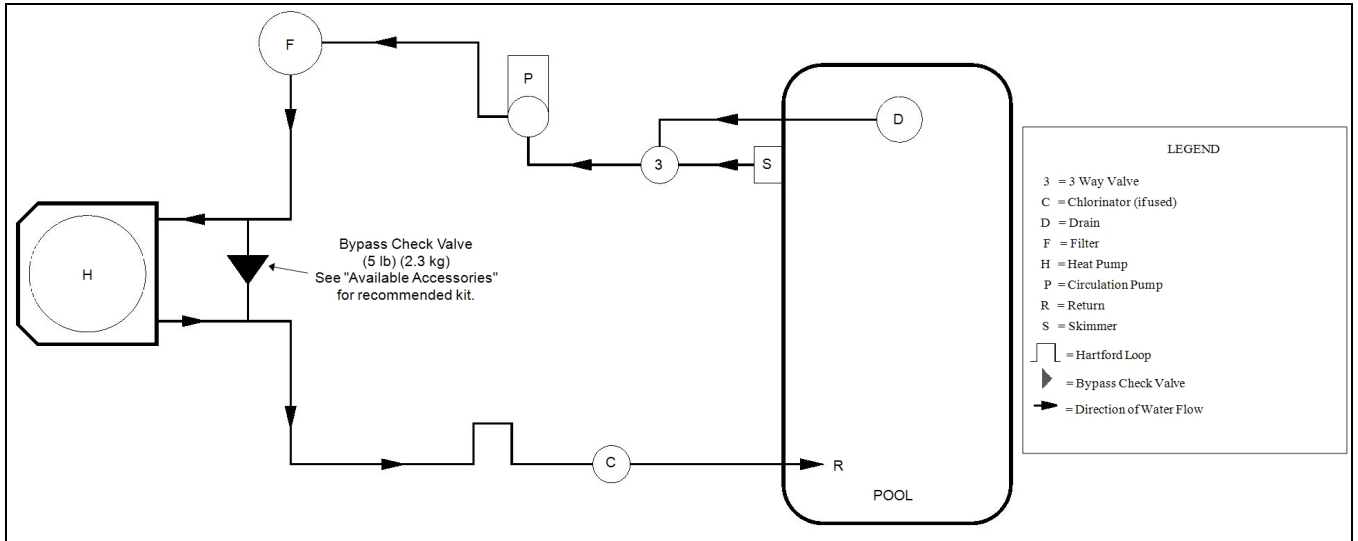

Heat Pump with Spillover Spa (One filter Pump)

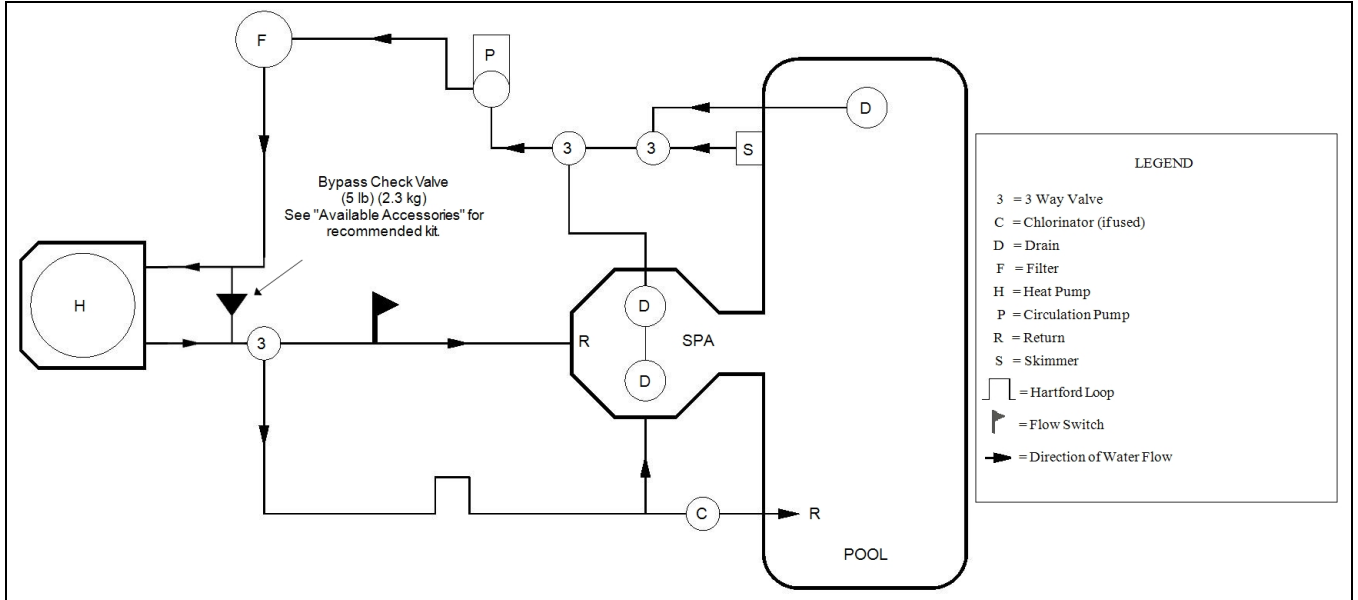

Heat Pump with Spillover Spa (Two filter Pumps)

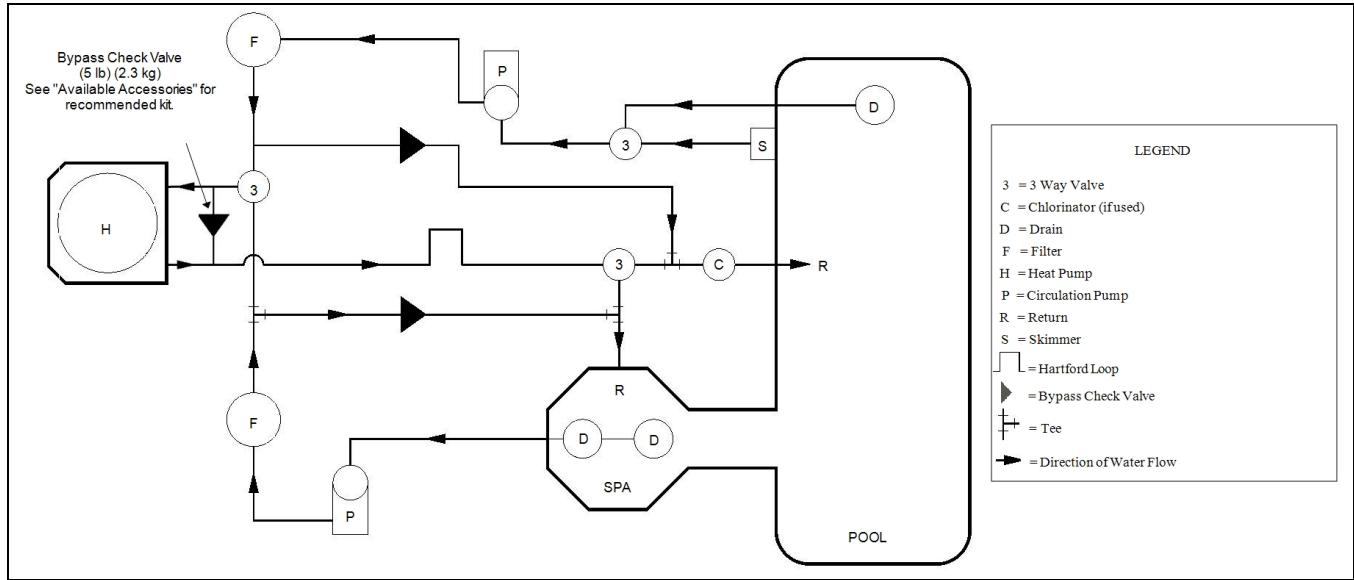

Heat Pump with Gas Heater backup

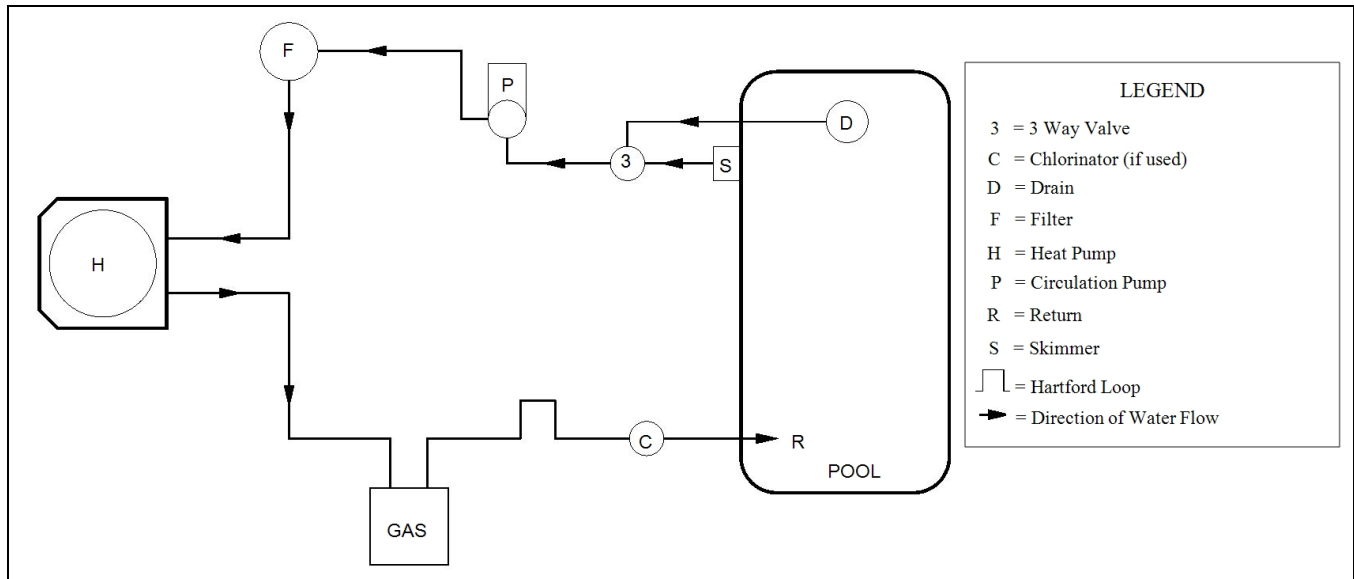

Heat Pump with Solar Panels in Plumbing Circuit (not controlled by AquaCal heat pump)

The solar panels are controlled by a system other than the Heat Pump.

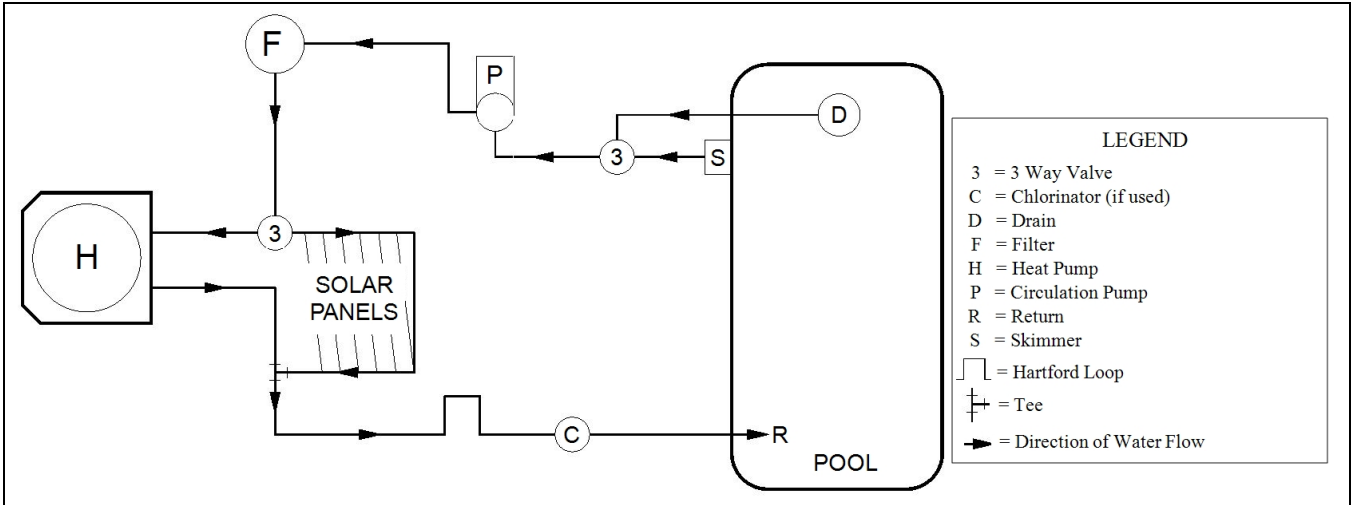

Heat Pump with Solar Panels in Plumbing Circuit (controlled by AquaCal heat pump)

See "Connecting and Configuring a Solar Control System (Optional)" on page 33.

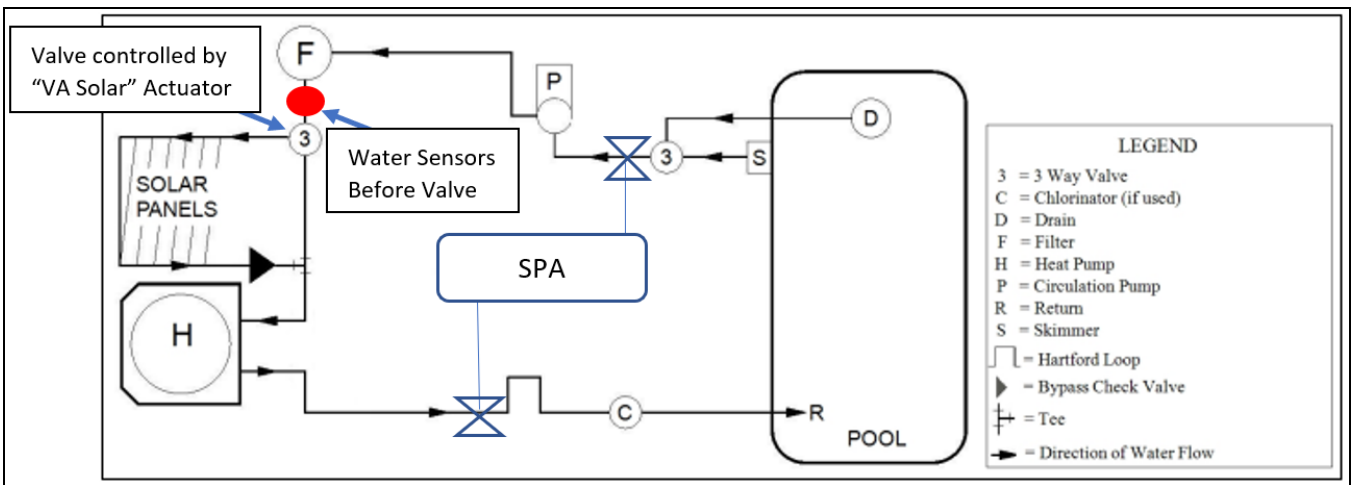

Multiple Air Source Heat Pumps

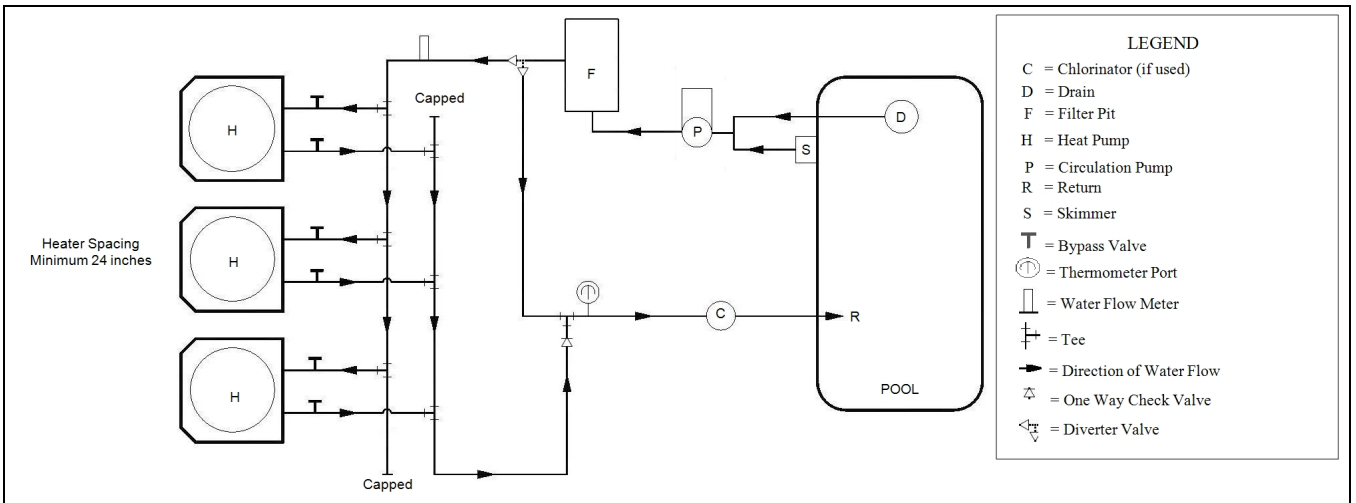

1.2.C Maintaining Ability to Winterize

Do not use glue on the threaded portion of the equipment's unions. A glued-in-place union will prevent the equipment from being properly winterized.

1.2.D Water Connections to Heat Pump

- Heat Pump union sizes are specified on diagrams.
- Connections to site plumbing are made via PVC solvent cement to the female slip socket of the plumbing unions.
- Plumbing unions are available from AquaCal®.

NOTICE

Failure to heed the following may result in damage to equipment.

- Do not use glue on the threaded portion of the equipment's unions. A glued-in-place union will prevent the equipment from being properly winterized.

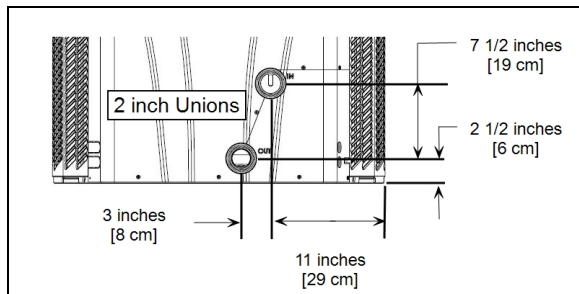

HeatWave SuperQuiet® SQ140R, SQ160R and SQ200R

TropiCool® TC1000C TC1500

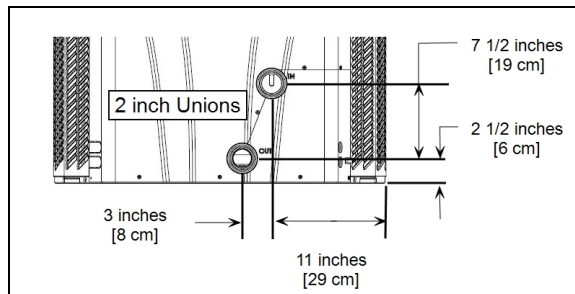

TropiCal® Inverter T035, T055, T075

TropiCool® TC500

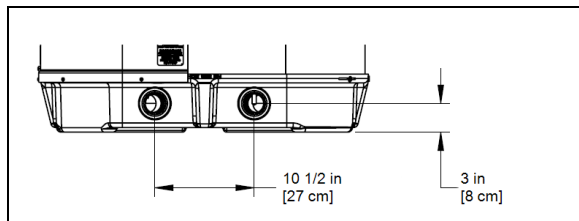
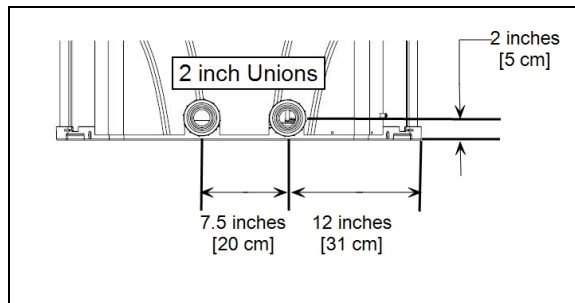

TropiCal® Inverter T170

1.2.E In-Line Chlorine Feeders

Place in-line chlorinators downstream from the heat pump and as low in elevation as possible.

- If an erosion type feeder is used, it is recommended that a Hartford Loop be installed to protect internal heat pump components.
- A Hartford Loop is not required when using a Salt Chlorine Generator.
- Avoid storing corrosive chemicals near the heat pump to minimize potential damage to the exterior of the heat pump.

Heat Pump with Erosion Tablet Feeder and Hartford Loop

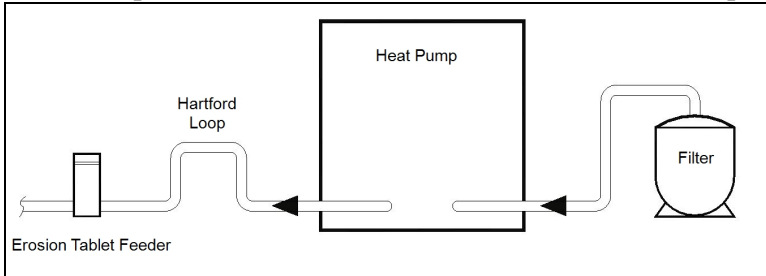

1.2.F Water Flow Rates

Maintain water flow rates as indicated. Please note, these specifications relate to the heat pump only. Code-specified whole system turnover rates must be satisfied.

NOTICE

Failure to heed the following may result in damage to equipment.

- Water flow exceeding maximum flow rates will negatively affect the total pool filtration performance and may damage the heat pump. This will not be covered under the equipment warranty.

MODEL	HEAT EXCHANGER TYPE	FLOW RATES	
		MINIMUM	MAXIMUM
SQ140	Titanium ThermoLink [®]	30 GPM (113.6 L/min)	70 GPM (265 L/min)
SQ200	Titanium ThermoLink [®]	30 GPM (113.6 L/min)	70 GPM (265 L/min)
SQ160	Titanium ThermoLink [®]	30 GPM (113.6 L/min)	70 GPM (265 L/min)
TC1000*	Titanium ThermoLink [®]	30 GPM (113.6 L/min)	70 GPM (265 L/min)
TC1500*	Titanium ThermoLink [®]	30 GPM (113.6 L/min)	70 GPM (265 L/min)

* Head Loss - 30 GPM = 1.5 PSI, 70 GPM = 8.2 PSI

PLEASE NOTE -

If minimum flow rates are not met, heat pump performance is reduced and performance will suffer. Internal safety devices may deactivate the heat pump with the following errors:

- **HIGH PRESSURE FAULT**
- **HP5 SYSTEM LOCKOUT**
- **LOW PRESSURE FAULT**
- **LP5 SYSTEM LOCKOUT**

- Operate water filtration devices per manufacturer's specifications. Dirty filters can cause a reduction of water flow to the heat pump. An increase of 7-10 psi (48 to 69 kPa) higher than the clean filter pressure typically reduces flow rates. This requires the filter to be cleaned or back-washed.
- Keep baskets free of debris. A large quantity of debris in the pump and skimmer baskets can reduce water flow.
- Check for improper valve settings. A partially closed valve after the filter, or a full-open bypass around the heat pump, will cause insufficient water flow through the heat pump.
- The maximum static pressure (or operating pressure) is 50 psi (345 kPa). These specifications relate to the heat pump only.
- Code-specified whole system turnover rates must be satisfied.

1.3 Electrical

DANGER

Failure to heed the following will result in injury or death.

- Deactivate power while routing wiring to control board.
- RISK OF ELECTRICAL SHOCK FROM ENERGY STORED IN CAPACITORS - MODELS EQUIPPED WITH VARIABLE FREQUENCY COMPRESSOR DRIVES STORE ELECTRICITY EVEN AFTER THE POWER HAS BEEN DEACTIVATED AT THE POWER BREAKER. ***Wait for 2 minutes after the shut down of equipment before servicing.***
- Follow all National Electric Codes (NEC) and/or State and Local guidelines.

WARNING

Failure to heed the following may result in injury or death.

- The information contained in this section is intended for use by qualified electricians familiar with electrical service-industry safety standards and methods.
- Locate the equipment disconnect as near to the heat pump as possible. Always satisfy applicable codes and standards.
- Never mount power-disconnects directly to the heat pump.
- In sizing power wiring, be especially aware of up-sizing requirements necessary due to wiring distances. Always satisfy applicable codes and standards.
- AquaCal® heat pumps are designed to use copper conductors, only. Do not use aluminum wire.
- If multiple heat pumps are on-site, confirm that the multiple heat pump configuration has been utilized. See "*Connecting Multiple Heat Pumps (Optional)*" on page 50. This will prevent multiple heat pumps attempting to start at the same time, causing an excessive power drop at start-up.

1.3.A Electrical Requirements

Standards

Standards	Title
NFPA 70, Nat'l Elec. Code 2017	The electrical installation must conform to the current version of the National Electric Code (NEC), and all applicable local and state codes
IEC 60335-1	Household and similar electrical appliances - Safety - General Requirements
IEC 60335-2	Household and similar electrical appliances - Safety – Particular requirements for electrical heat pumps, air-conditioners, and dehumidifiers
UL 1995 & CSA C22.2 No. 236-15	Standard for Safety - Heating and cooling equipment

Table 1 - Standards

Grounding and Bonding

Follow local code requirements for proper grounding and bonding of heat pump equipment.

- A bonding lug has been provided on the heat pump.

Surge Suppression

The use of approved commercial surge protectors is strongly recommended.

Sizing the Electrical Service

Refer to equipment data plate for specific information required to size electrical service and over-current protection of the heat pump. Sizing is based on data plate information, wire size, wiring devices, and over-current protection per applicable local codes and standards.

Minimum and Maximum Operating Voltage

The heat pump must operate within specified voltages.

NOTICE

Failure to heed the following may result in damage to equipment.

- Operating equipment under higher or lower voltage conditions may result in damage to your compressor, motors or other electrical components. This damage will not be covered by the product warranty.
1. Measure site voltage. The site voltage **MUST** be measured under “FULL LOAD” conditions. Activate all equipment using the same electrical panel as the heat pump.
 2. If measured site voltage is outside listed ranges, immediately deactivate equipment until site conditions have been corrected. If unsure of heat pump equipment rating, please

Equipment Rating	Minimum Site Voltage	Maximum Site Voltage
A Voltage (208 to 230 Volts) Single Phase 60 hertz	200 Volts	253 Volts
B Voltage (208 to 230 Volts) Three Phase 60 hertz	200 Volts	253 Volts
D Voltage (380 to 420 Volts) Three Phase 50 hertz	361 Volts	441 Volts
E Voltage (380 Volts) Three Phase 60 hertz	361 Volts	399 Volts
G Voltage (460 Volts) Three Phase 60 hertz	437 Volts	483 Volts
H Voltage (200 to 240 Volts) Single Phase 50 hertz	180 Volts	264 Volts

1.3.B Incoming Power Access Holes

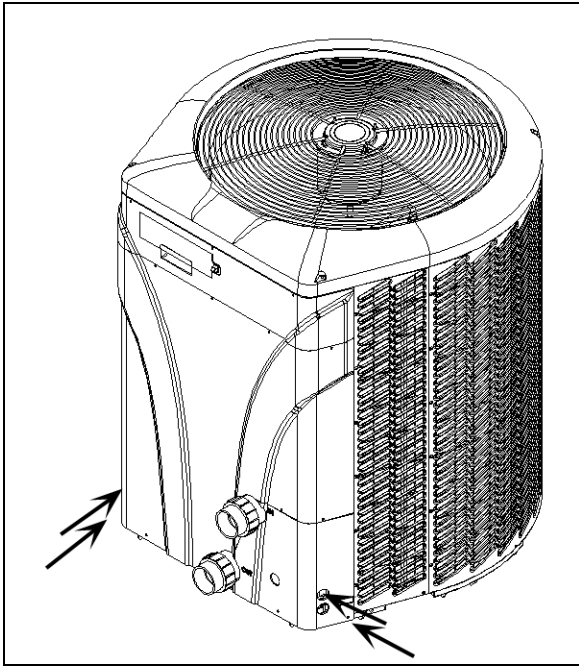

HeatWave SuperQuiet® SQ140R, SQ160R
and SQ200R
TropiCool® TC1000C TC1500

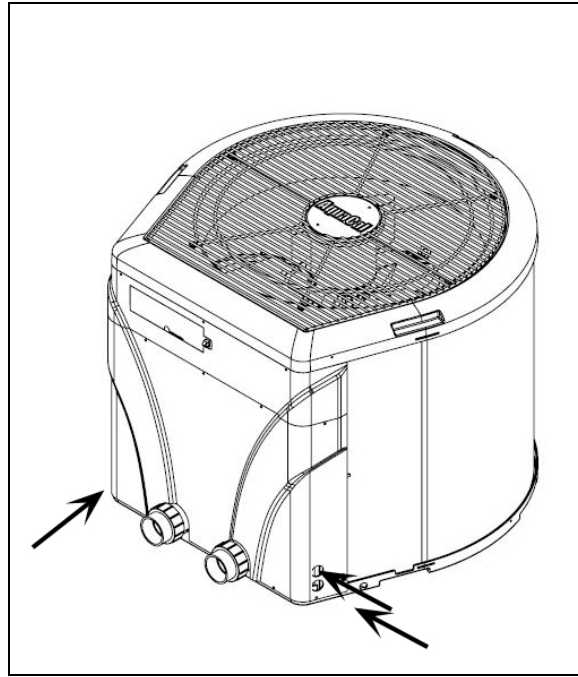

TropiCal® Inverter T035, T055, T075
TropiCool® TC500

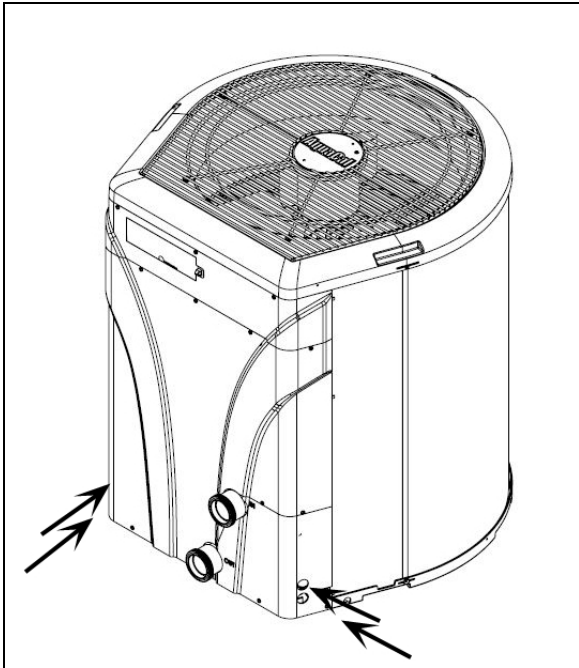

TropiCal® Inverter T170

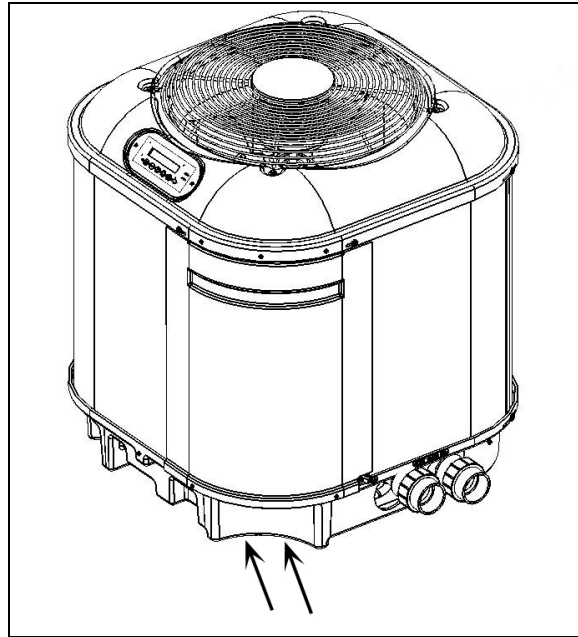

1.3.C Access Panels

DANGER

Failure to heed the following will result in injury or death.

- Deactivate power while routing wiring to control board.
- RISK OF ELECTRICAL SHOCK FROM ENERGY STORED IN CAPACITORS - MODELS EQUIPPED WITH VARIABLE FREQUENCY COMPRESSOR DRIVES STORE ELECTRICITY EVEN AFTER THE POWER HAS BEEN DEACTIVATED AT THE POWER BREAKER. ***Wait for 2 minutes after the shut down of equipment before servicing.***
- Follow all National Electric Codes (NEC) and/or State and Local guidelines.

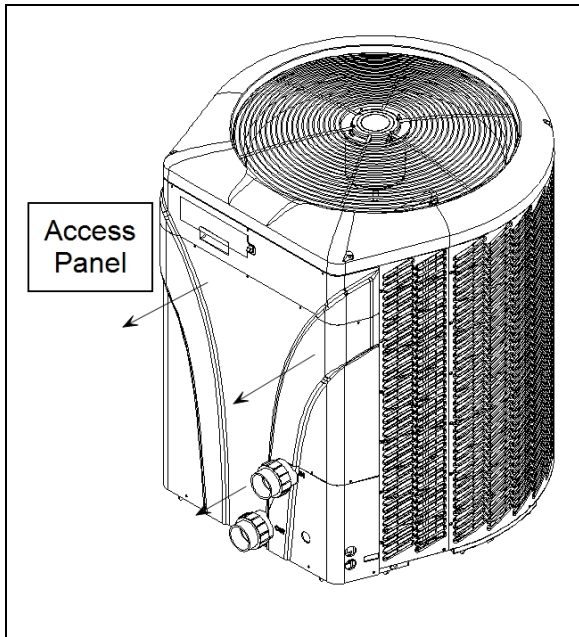

HeatWave SuperQuiet® SQ140R, SQ160R
and SQ200R
TropiCool® TC1000C TC1500

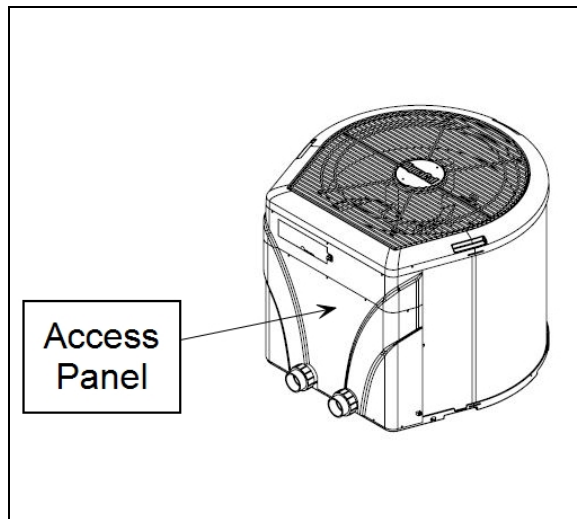
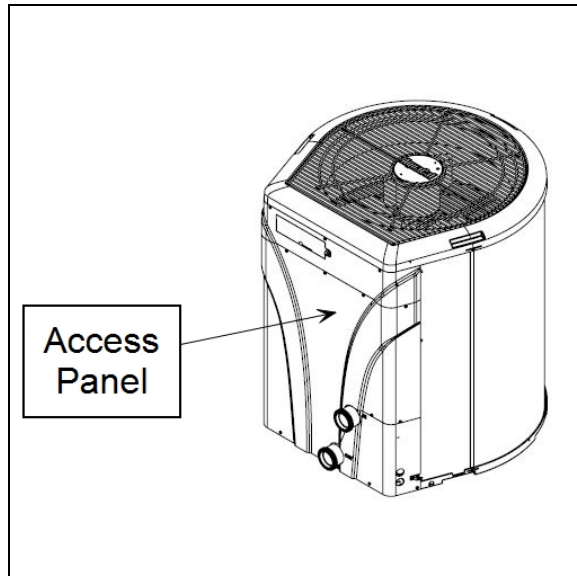

TropiCal® Inverter T035, T055, T075
TropiCool® TC500

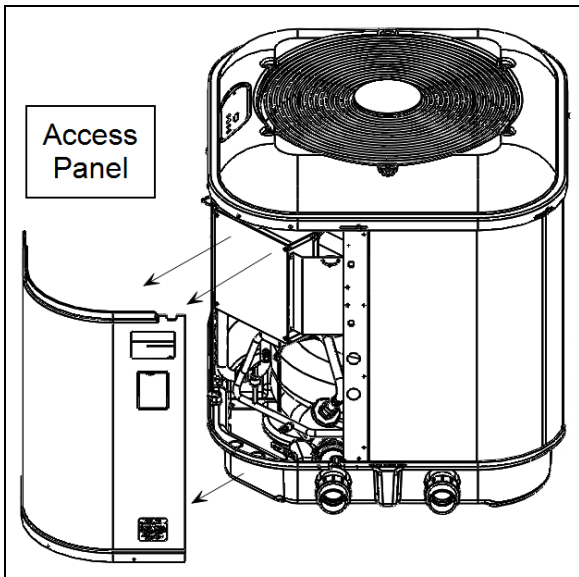

TropiCal® Inverter T170

1.3.D Verifying Transformer Setting (Select Units)

Transformer voltage must be confirmed and set correctly depending on the measured voltage found on the site. Incorrect settings may cause heat pump damage. The following procedure will allow the installer to set the heat pump's transformer for the appropriate site voltage.

⚠ DANGER

Failure to heed the following will result in injury or death.

- Deactivate power while routing wiring to control board.
- **RISK OF ELECTRICAL SHOCK FROM ENERGY STORED IN CAPACITORS - MODELS EQUIPPED WITH VARIABLE FREQUENCY COMPRESSOR DRIVES STORE ELECTRICITY EVEN AFTER THE POWER HAS BEEN DEACTIVATED AT THE POWER BREAKER. *Wait for 2 minutes after the shut down of equipment before servicing.***
- Follow all National Electric Codes (NEC) and/or State and Local guidelines.

⚠ WARNING

Failure to heed the following may result in injury or death.

- The information contained in this section is intended for use by qualified technicians, familiar with electrical service-industry safety standards and methods.

**Example of heat pump transformer
(Varies between models)**

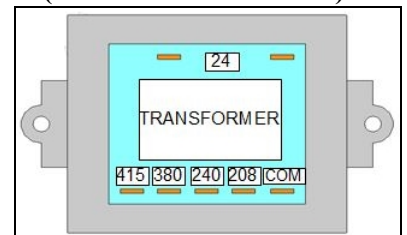

1. Turn heat pump on by adjusting the thermostat to call for heating or cooling. If more than one heat pump is on-site, turn them all on. Allow time for all heat pump compressors to activate.
2. Measure the running site voltage.
3. Confirm transformer tap is set for the measured site voltage. If more than one voltage tap is shown, select the voltage nearest to the running site voltage.

PLEASE NOTE -

- If more than one voltage is shown on the equipment’s data plate, the factory default setting is usually the higher voltage on the transformer.
- As an example, a "208/230" voltage will be set to "240" from the factory.

1.3.E Schematic Location

Schematics are located on the inside of the electrical panel.

1.4 Connecting Circulation Pumps (Optional)

In the following example a circulation pump is connected to the heat pump.

PLEASE NOTE:

Do not attempt to combine different brands of variable speed circulation pumps when connecting to this heat pump. These pumps can have different protocol that may be incompatible from brand to brand.

ALSO NOTE:

While the AquaCalheat pump has the capability of controlling up to six circulation pumps, this depends on how many addresses the circulation pump has provided. Each circulation pump must have a distinct address.

EXAMPLES IN THIS SECTION:

1.4.A Connections	19
1.4.B Manually Configure a Circulation Pump	21
1.4.C Deleting Equipment	22

1.4.A Connections

This section describes how to connect circulation pumps to the heat pump.

⚠ DANGER

Failure to heed the following will result in injury or death.

- Deactivate power while routing wiring to control board.
- RISK OF ELECTRICAL SHOCK FROM ENERGY STORED IN CAPACITORS - MODELS EQUIPPED WITH VARIABLE FREQUENCY COMPRESSOR DRIVES STORE ELECTRICITY EVEN AFTER THE POWER HAS BEEN DEACTIVATED AT THE POWER BREAKER. Wait for 2 minutes after the shut down of equipment before servicing.
- Follow all National Electric Codes (NEC) and/or State and Local guidelines.

WARNING

Failure to heed the following may result in injury or death.

- Installation of this equipment by anyone other than a qualified installer can result in a safety hazard.
- The information contained throughout the "Installation" section is intended for use by qualified installation technicians familiar with the swimming Pool/Spa safety standards.

NOTICE

Failure to heed the following may result in damage to equipment.

- Failure to protect equipment against corrosive conditions will adversely affect the life of the equipment and will void equipment warranty.

1. Turn off power at heat pump's power disconnect.
2. ***Wait two minutes for capacitors to discharge before proceeding.***
3. Remove heat pump electrical access panel.
4. Route circulation pump wiring to the low voltage side of the electrical enclosure. Follow all National Electric Codes (NEC) unless State or Local guidelines supersede. The wiring must be 22-gauge (minimum), 2-conductor, shielded, outdoor rated wires.
5. Connect circulation pump wires to power control board port "B" (RS-485) .

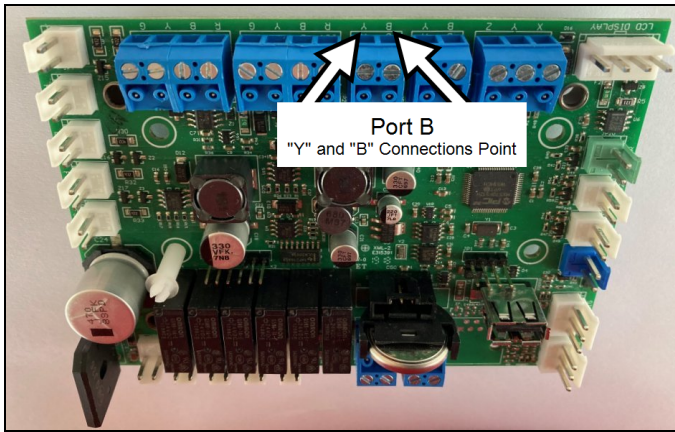

Figure 1 - Device Connections





6. Reattach heat pump access panel.
7. Apply power to heat pump.
8. An installation wizard will start automatically. The connected equipment can now be configured using the installation wizard's preset options. See "*Site Configuration Presets (Optional)*" on page 60.

1.4.B Manually Configure a Circulation Pump

In the following example a circulation pump connected to the control board on port "B" is configured to be used. Usually an installation preset is used. This option is available if using a preset is undesired.

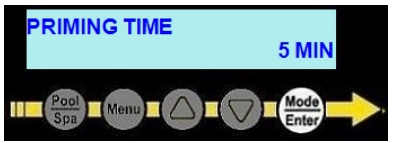
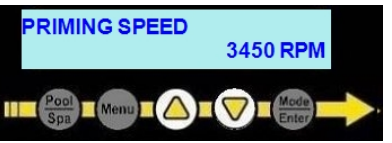
Enter "Equipment" menus, then proceed

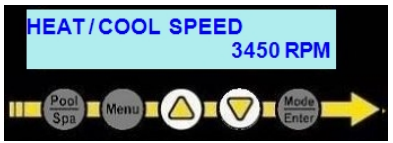
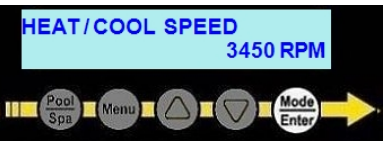
<p>IF UNIT IS ASLEEP, SWIPE TO WAKE UP</p> 	<p>A PRESS MENU BUTTON</p> 	<p>B USE ARROWS TO "EQUIPMENT"</p> 
<p>C PRESS "ENTER"</p> 	<p>1 USE ARROWS TO MENU "NEW EQUIPMENT"</p> 	<p>2 ENTER TO SELECT</p> 
<p>3 USE ARROWS TO "PUMP"</p> 	<p>4 ENTER TO SELECT</p> 	<p>5 USE ARROWS TO MENU DEVICE NAME</p> 
<p>6 ENTER TO SAVE</p> 	<p>7 USE ARROWS TO SELECT PUMP TYPE</p> 	<p>8 ENTER TO SAVE</p> 
<p>9 USE ARROWS TO SELECT DEVICE'S PORT</p> 	<p>10 ENTER TO SELECT</p> 	<p>11 USE ARROWS TO MINIMUM RPM SPEED</p> 
<p>12 ENTER TO SAVE</p> 	<p>13 USE ARROWS TO MAXIMUM RPM SPEED</p> 	<p>14 ENTER TO SAVE</p> 

<p>15 USE ARROWS TO PRIMING TIME</p> 	<p>16 ENTER TO SAVE</p> 	<p>17 USE ARROWS TO PRIMING SPEED</p> 
<p>18 ENTER TO SAVE</p> 	<p>19 USE ARROWS TO HEAT / COOL SPEED</p> 	<p>20 ENTER TO SAVE</p> 
<p>21 PRESS BUTTON UNDER "YES" TO SAVE SETUP</p> 	<p>MENU TO EXIT, PRESS & HOLD TO STATUS</p> 	

The configured device will now be available for insertion into a group.

1.4.C Deleting Equipment



Configurations for equipment can be removed from the system. These configurations will automatically be deleted from any group upon removal.

NOTICE Failure to heed the following may result in damage to equipment.

- Removing the circulation pump from the system can prevent the heat pump from operating.
- Removing the circulation pump from the system can prevent proper filtration of the pool. Confirm proper water circulation is maintained.

In the following example a circulation pump configuration is removed from the system. The device will also be removed from all groups.

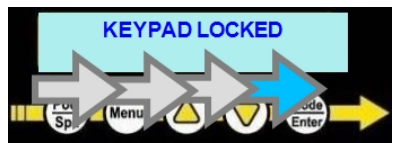
Enter "Equipment" menus, then proceed

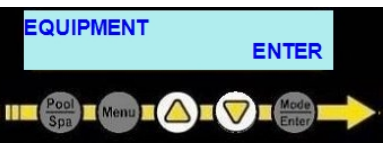
<p>IF UNIT IS ASLEEP, SWIPE TO WAKE UP</p> 	<p>A PRESS MENU BUTTON</p> 	<p>B USE ARROWS TO "EQUIPMENT"</p> 
--------------------------------------------------------------------------------------------------------------------------------	------------------------------------------------------------------------------------------------------------------------	---------------------------------------------------------------------------------------------------------------------------------

C PRESS "ENTER"

1 USE ARROWS TO MENU "DELETE EQUIPMENT"

2 PRESS ENTER TO EDIT

3 USE ARROWS TO DEVICE TO REMOVE

4 ENTER TO SELECT

5 PRESS BUTTON UNDER "YES" TO CONFIRM

MENU TO EXIT, PRESS & HOLD TO STATUS

1.5 Connecting an External Controller (Optional)

To support a direct connection to an external controller, AquaCal® heat pumps are equipped with removable terminal blocks on the control board. The control board is located on the low-voltage side of the electrical enclosure.

PLEASE NOTE

If using an external control device, other than a PoolSync®, the AquaCal heat pump will not directly control a circulation pump. (Presets for that option will not be shown if a third party external control device is configured).

IN THIS SECTION:

1.5.A PoolSync®	24
1.5.B FS2 (Pool-Spa)	25
1.5.C SMART Controllers	26
1.5.D 2-wire Controllers (Pool-Spa)	30
1.5.E 3-wire Controllers (Pool-Off-Spa)	32

1.5.A PoolSync®



Select heat pumps will automatically allow for WiFi capabilities using a PoolSync®.

- The PoolSync® device will allow direct control of the heat pump from a mobile device.
- Contact installing dealer to order this product.
- Go online and download the PoolSync® manual for information on connecting and using this device with an AquaCal heat pump.
<https://www.aquacal.com/accessories/>
- Confirm the PoolSync® has been set as an active external control device. See "*Confirm PoolSync® is set to operate*" below.

Confirm PoolSync® is set to operate

The heat pump has this device active by default. In this example, however, the heat pump is reconfigured to use the PoolSync® device instead of a prior configuration of a "SMART" external controller.

Enter "Advanced" menus, then proceed

<p>IF UNIT IS ASLEEP, SWIPE TO WAKE UP</p> <p>KEYPAD LOCKED</p>	<p>A PRESS MENU BUTTON</p> <p>WATER TEMP ##°F HEAT SETPOINT ##°F</p>	<p>B USE ARROWS TO "SYSTEM"</p> <p>SYSTEM ENTER</p>
<p>C PRESS "ENTER"</p> <p>SYSTEM ENTER</p>	<p>D USE ARROWS TO "ADVANCED"</p> <p>ADVANCED ENTER</p>	<p>E PRESS "ENTER"</p> <p>ADVANCED ENTER</p>
<p>1 USE ARROWS TO "EXTERNAL CONTROL"</p> <p>EXTERNAL CONTROL ENTER</p>	<p>2 ENTER TO SELECT</p> <p>EXTERNAL CONTROL ENTER</p>	<p>3 ARROWS TO MODE</p> <p>EXTERNAL CONTROL MODE SMART</p>
<p>4 ENTER TO EDIT</p> <p>EXTERNAL CONTROL MODE SMART</p>	<p>5 ARROWS TO "POOLSUNC"</p> <p>EXTERNAL CONTROL POOLSUNC</p>	<p>6 ENTER TO SELECT</p> <p>EXTERNAL CONTROL POOLSUNC</p>

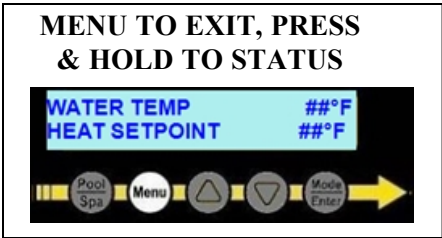

1.5.B FS2 (Pool-Spa)

A direct connection to an external flow relay switch (FS2 Controller) has been provided on the terminal control board.

This pool / spa relay switch will automatically change between the pool and spa thermostat depending on the position of the plumbing valves.

- When water flows to the pool, the pool group will be used.
- When water flows to the spa, the spa group will be used.

NOTICE Failure to heed the following may result in damage to equipment.

- The wire size connecting the relay switch must be a minimum 22-gauge, 2-conductor, low-voltage wire.
- Use FS2 (**dry contact**) connection on the control board.

Connecting Switch



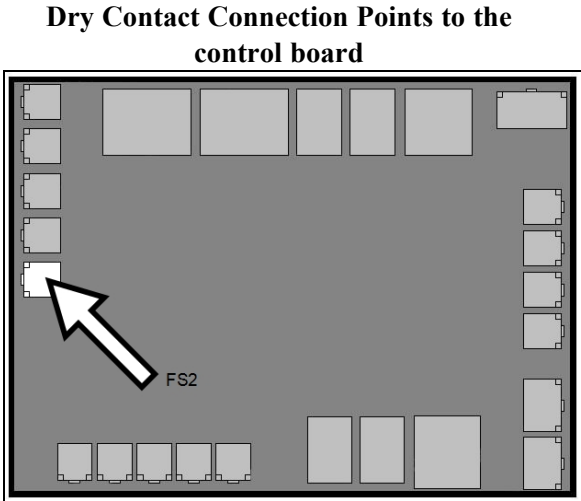



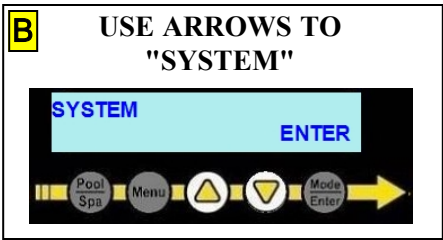
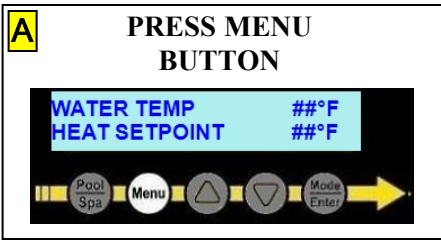
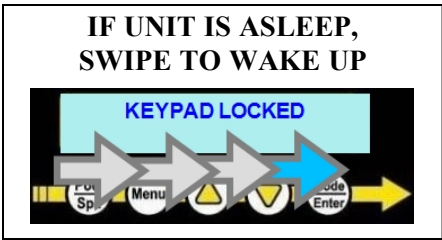

1. Deactivate power to heat pump.
2. Plumb the switch as indicated in accessories installation instructions.
3. Remove heat pump electrical access panel.
4. Using two of the three wires from the installed switch, route wires to the low voltage side of the electrical enclosure. The third wire is not used. Follow all National Electric Codes (NEC) unless State or Local guidelines supersede.
5. Connect the wires to the jumper provided. Polarity is not important.
6. Reattach heat pump access panel.
7. Apply power to heat pump.
8. Configure the heat pump to accept the pool / spa relay switch. See "Configuring Switch" below.

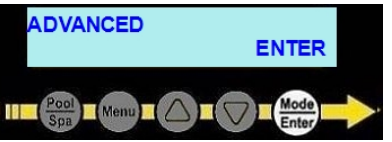

Configuring Switch

Enter "Advanced" menus, then proceed

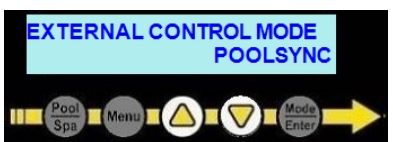

<p>C PRESS "ENTER"</p> 	<p>D USE ARROWS TO "ADVANCED"</p> 	<p>E PRESS "ENTER"</p> 
<p>1 USE ARROWS TO "EXTERNAL CONTROL"</p> 	<p>2 ENTER TO SELECT</p> 	<p>3 ARROWS TO MODE</p> 
<p>4 ENTER TO SELECT</p> 	<p>5 ARROWS TO "FS2 POOL-SPA"</p> 	<p>6 ENTER TO SAVE</p> 
<p>MENU TO EXIT, PRESS & HOLD TO STATUS</p> 		

1.5.C SMART Controllers

Smart Controllers include the Pentair IntelliCenter®, Pentair EasyTouch®, Pentair IntelliTouch®, Jandy AquaLink®, etc.

NOTICE

Failure to heed the following may result in damage to equipment.

- **Do not use an electric heater connection on external controllers for heat pump wiring.** This can cause damage to external controllers, heat pumps, and pad equipment. This damage is NOT covered by warranty.
- The wire size connecting the external controller to the heat pump must be 22-gauge, 2-conductor, low-voltage wire.
- Use the two middle data lines on the external controller's standard communication port (RS-485). Do not use the outside power or ground connection on the port.

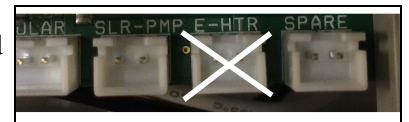

Wire Connections

1. Deactivate power to heat pump and external controller.
2. Remove electrical access panels on the heat pump and external controller.
3. Route 22-gauge, 2-conductor, low-voltage wires from the external controller communication port (com port) to the low voltage side of the heat pump's electrical enclosure. Do not use the power or ground wire.

External Controller Communication Port

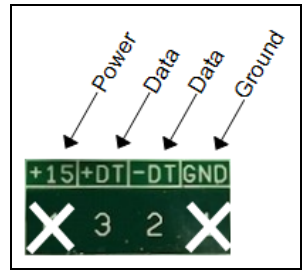

4. Connect control wires to the heat pump's "Port B" of the control board as indicated. See Figure 2 and Figure 3.
 - It is OK to double up wires at the external controller connection if necessary.
 - If, for example, the external controller is using the data port for an indoor controller, add wires to the existing configuration. *Connectors can be removed from terminals for ease in connecting wires. See Figure 4.*

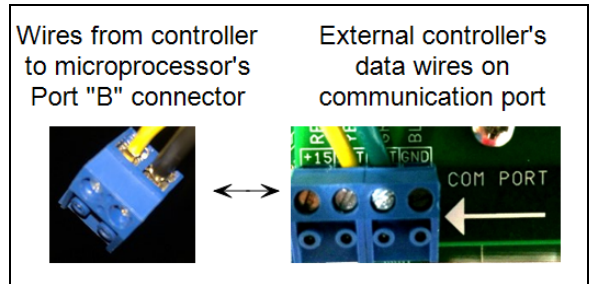

Figure 2

Typically a smart controller will have four (4) wires for interfacing with the heat pump. The power and ground (usually the 1st and 4th wire) are not used.

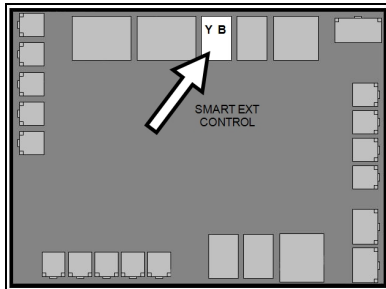

Figure 3



Figure 4

5. If dip-switch settings are required, configure them on the external controller now.



Failure to heed the following will result in injury or death.

- Deactivate power to the external controller while setting dip-switches

Example - Jandy AquaLink® :

This external controller has dip switches. Confirm they are properly positioned to operate a heat pump.

- Set dip-switch "S2" #1 to "ON". The solar option is to be used for the heat pump.
- Check Jandy documentation for any further dip switch settings.

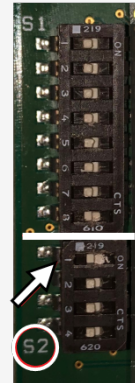

6. If additional sensors are required on the external controller, install them on the external controller now.

Example - Pentair EasyTouch® and Pentair IntelliTouch® :

Some controllers require an additional sensor be connected to the external controller's power supply circuit board at the solar connection point. The sensor is not used but will show an error if not connected.









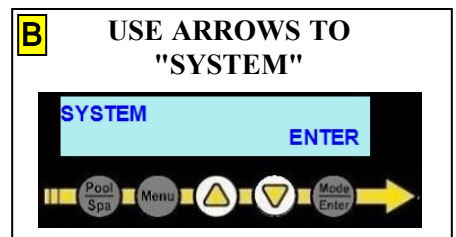
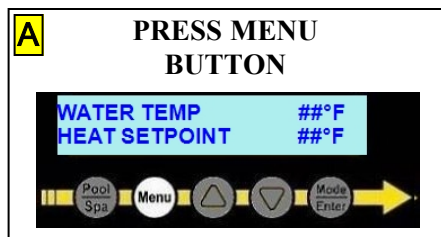
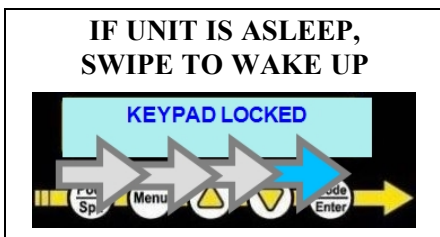

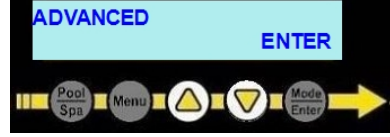

7. Reinstall electrical access panels on both the heat pump and external controller.
8. Reactivate power to heat pump and external controller.
9. Configure the heat pump to accept external controller signal. See "Configure for Smart Controller" below.

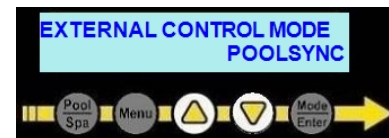
Configure for Smart Controller

Enter "Advanced" menus, then proceed

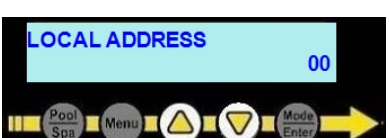

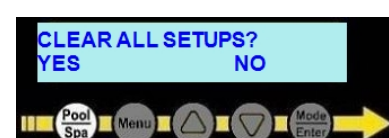
<p>C PRESS "ENTER"</p> 	<p>D USE ARROWS TO "ADVANCED"</p> 	<p>E PRESS "ENTER"</p> 
<p>1 USE ARROWS TO "EXTERNAL CONTROL"</p> 	<p>2 ENTER TO SELECT</p> 	<p>3 ARROWS TO MODE</p> 
<p>4 ENTER TO EDIT</p> 	<p>5 ARROWS TO "SMART"</p> 	<p>6 ENTER TO SAVE</p> 
<p>7 USE ARROWS TO SET LOCAL ADDRESS</p> 	<p>8 ENTER TO SAVE</p> 	<p>9 CONFIRM OK TO CLEAR ANY EXISTING SETUPS</p> 

PLEASE NOTE:

This action will wipe all previous settings in favor of the new configuration. This includes external controller settings, optional device settings, groups, equipment, schedules, and site specific settings. Additional site specific settings may need to be put in place.

The system will restart. If successful, the heat pump should now display "Under Remote Control".

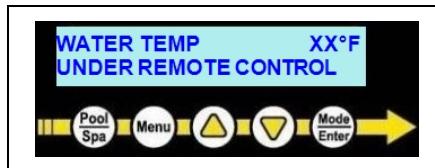

10. If after 45 seconds, the heat pump displays a **"SMART COMM FAULT"**:

- A. **Confirm dip switches** - If external controller uses dip switches, confirm switches are in the correct position. Otherwise, proceed to confirm wiring.
 - a. Deactivate power to the external controller.
 - b. Remove access panel on external controller.
 - c. Check the external controller manual for proper dip switch positioning and confirm dip switches.
 - d. Reinstall electrical access panel.
 - e. Reactivate power to the controller.
 - f. If the fault persists, proceed to confirm wiring.

- B. **Confirm wiring** - Confirm wires are oriented properly on the heat pump's "Port B" of the control board.
 - a. Deactivate power to heat pump and external controller.
 - b. Remove the access panel on the heat pump.
 - c. Reverse wires on "Port B".
 - d. Reinstall electrical access panel.
 7. Reactivate power to the controller.
 8. Reactivate power to the heat pump.
 - C. If fault continues to occur, check with the manufacturer of the external controller for additional advice on using a heat pump with the controller.
11. After establishing a connection from the external controller to the heat pump, further programming will be required at the external controller.
- See external controller manuals or contact installer or manufacturer of that product.

1.5.D 2-wire Controllers (Pool-Spa)

PLEASE NOTE

2-Wire controllers are not designed to control chiller operation.

For full functionality, the Heat and Cool, and Cool Only heat pumps must use an external SMART controller. Check with the external controller manufacturer for more information.

NOTICE

Failure to heed the following may result in damage to equipment.

- Confirm equipment connected to heat pump before selecting this option . All existing configurations will be cleared.

1. Deactivate power to heat pump.
2. Remove heat pump electrical access panel.
3. Route 22-gauge (minimum), 2-conductor, low-voltage wires from the controller to the low voltage side of the heat pump's electrical enclosure. Follow all National Electric Codes (NEC) unless State or Local guidelines supersede.
4. Connect the controller wires to the control board port labeled "Ext Controller" with the terminals labeled "Y" and "Z" as follows. See Figure 5.
 - Connect one wire to "Y".
 - Connect other wire to "Z".
 - The polarity of the wire is not important.
5. Reattach heat pump access panel.
6. Apply power to heat pump.
7. Configure the heat pump to accept a 2-wire external controllers signal as shown. See "Configure 2-wire controller" on the next page.

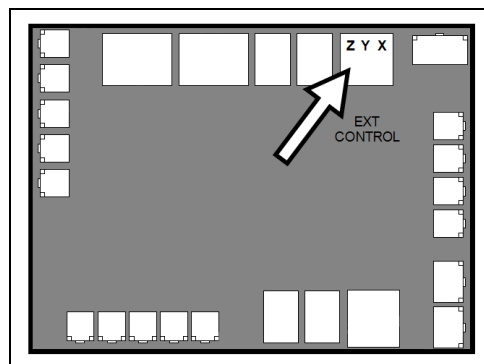



Figure 5

Configure 2-wire controller

Enter "Advanced" menus, then proceed

IF UNIT IS ASLEEP, SWIPE TO WAKE UP



KEYPAD LOCKED

Pool Spa Menu Mode Enter

A PRESS MENU BUTTON



WATER TEMP ##°F
HEAT SETPOINT ##°F

Pool Spa Menu Mode Enter

B USE ARROWS TO "SYSTEM"



SYSTEM ENTER

Pool Spa Menu Mode Enter

C PRESS "ENTER"



SYSTEM ENTER

Pool Spa Menu Mode Enter

D USE ARROWS TO "ADVANCED"



ADVANCED ENTER

Pool Spa Menu Mode Enter

E PRESS "ENTER"



ADVANCED ENTER

Pool Spa Menu Mode Enter

1 USE ARROWS TO MENU "EXTERNAL CONTROL"



EXTERNAL CONTROL ENTER

Pool Spa Menu Mode Enter

2 ENTER TO SELECT



EXTERNAL CONTROL ENTER

Pool Spa Menu Mode Enter

3 USE ARROWS TO MODE



EXTERNAL CONTROL MODE
POOLSYNC

Pool Spa Menu Mode Enter

4 ENTER TO EDIT



EXTERNAL CONTROL MODE
POOLSYNC

Pool Spa Menu Mode Enter

5 USE ARROWS TO CHANGE TO "2WIRE"



EXTERNAL CONTROL MODE
2WIRE

Pool Spa Menu Mode Enter

6 ENTER TO SAVE



EXTERNAL CONTROL MODE
2WIRE

Pool Spa Menu Mode Enter

7 PRESS BUTTON UNDER "YES"



CLEAR ALL SETUPS?
YES NO

Pool Spa Menu Mode Enter

PLEASE NOTE:
This action will wipe all previous settings in favor of the new configuration. This includes external controller settings, optional device settings, groups, equipment, schedules, and site specific settings. Additional site specific settings may need to be put in place.

1.5.E 3-wire Controllers (Pool-Off-Spa)

1. Deactivate power to heat pump.
2. Remove heat pump electrical access panel.
3. Route 22-gauge (minimum), 2-conductor, low-voltage wires from the controller to the low voltage side of the heat pump's electrical enclosure. Follow all National Electric Codes (NEC) unless State or Local guidelines supersede.
4. Connect the controller wires to the control board as follows:
 - Connect "Low" or "Pool" wire to "X".
 - Connect "Common" wire to "Y" (for 3-wire controllers with an "Off" position).
 - Connect "High" or "Spa" wire to "Z".
5. Reattach heat pump access panel.
6. Apply power to heat pump.
7. Configure heat pump to accept a 3-wire external controller signal as shown.

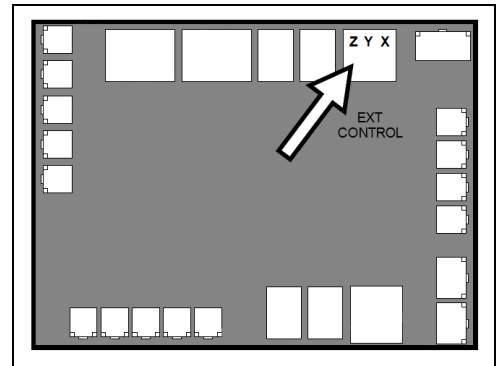

Figure 6

Enter "Advanced" menus, then proceed

<p>IF UNIT IS ASLEEP, SWIPE TO WAKE UP</p>	<p>A PRESS MENU BUTTON</p>	<p>B USE ARROWS TO "SYSTEM"</p>
<p>C PRESS "ENTER"</p>	<p>D USE ARROWS TO "ADVANCED"</p>	<p>E PRESS "ENTER"</p>
<p>1 USE ARROWS TO MENU "EXTERNAL CONTROL"</p>	<p>2 ENTER TO EDIT</p>	<p>3 USE ARROWS TO MODE</p>
<p>4 ENTER TO EDIT</p>	<p>5 USE ARROWS TO "3WIRE POOL-OFF-SPA"</p>	<p>6 ENTER TO SAVE</p>

MENU TO EXIT, PRESS
& HOLD TO STATUS



1.6 Connecting and Configuring a Solar Control System (Optional)

To support a direct connection to solar control systems, the AquaCal® heat pump must be equipped with an optional expansion board. This expansion board would need to be installed on the heat pump's main control board. The control board is located on the low-voltage side of the electrical enclosure. It will also be necessary to connect an actuator, roof sensor, and two additional water temperature sensors.

PLEASE NOTE:

If the expansion board is not found, check with the installing dealer or manufacturer for availability. See "Expansion Board Upgrade Kit (# STK0247)" on page 108.

1.6.A Connecting a Solar Control Actuator

An actuator must be installed for automatic control of a solar diversion valve. Follow manufacturer directions on installing the actuator. The actuator control wiring is to be connected to the "VA SOLAR" connection point.

⚠ DANGER

Failure to heed the following will result in injury or death.

- Deactivate power while routing wiring to control board.
- RISK OF ELECTRICAL SHOCK FROM ENERGY STORED IN CAPACITORS - MODELS EQUIPPED WITH VARIABLE FREQUENCY COMPRESSOR DRIVES STORE ELECTRICITY EVEN AFTER THE POWER HAS BEEN DEACTIVATED AT THE POWER BREAKER. ***Wait for 2 minutes after the shut down of equipment before servicing.***
- Follow all National Electric Codes (NEC) and/or State and Local guidelines.

⚠ WARNING

Failure to heed the following may result in injury or death.

- This section is only for qualified installers who are familiar with the swimming pool and spa safety standards.
- The installer must be familiar with service industry techniques.

1. Turn off power at heat pump's power disconnect.
2. ***Wait two minutes for capacitors to discharge before proceeding.***
3. Remove heat pump's electrical access panel.
4. Route actuator wiring to the low voltage side of the electrical enclosure.
5. Connect solar diversion valve actuator to "VA Solar" on the board.
6. Reattach heat pump access panel.

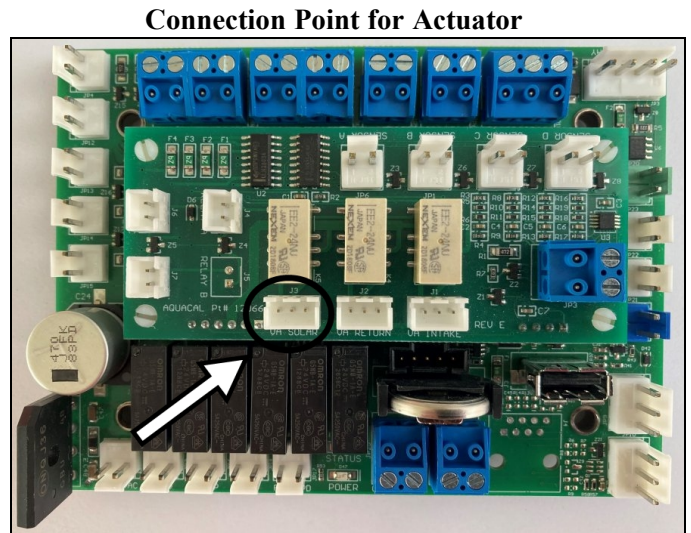

1.6.B Connecting a Solar Control (Roof) Temperature Sensor

A roof sensor must be installed for monitoring temperature differences between the roof temperature and the pool / spa water temperatures. This sensor is usually located on the roof's solar panels.

DANGER

Failure to heed the following will result in injury or death.

- Deactivate power while routing wiring to control board.
- RISK OF ELECTRICAL SHOCK FROM ENERGY STORED IN CAPACITORS - MODELS EQUIPPED WITH VARIABLE FREQUENCY COMPRESSOR DRIVES STORE ELECTRICITY EVEN AFTER THE POWER HAS BEEN DEACTIVATED AT THE POWER BREAKER. ***Wait for 2 minutes after the shut down of equipment before servicing.***
- Follow all National Electric Codes (NEC) and/or State and Local guidelines.

WARNING

Failure to heed the following may result in injury or death.

- This section is only for qualified installers who are familiar with the swimming pool and spa safety standards.
- The installer must be familiar with service industry techniques.

1. Turn off power at heat pump's power disconnect.
2. ***Wait two minutes for capacitors to discharge before proceeding.***
3. Remove heat pump's electrical access panel.
4. Route 22-gauge (minimum), 2-conductor, shielded, outdoor rated sensor wiring to the low voltage side of the electrical enclosure.
5. Connect roof sensor to "Sensor B" on the board.
6. Reattach heat pump access panel.

Connection Point for Roof Sensor

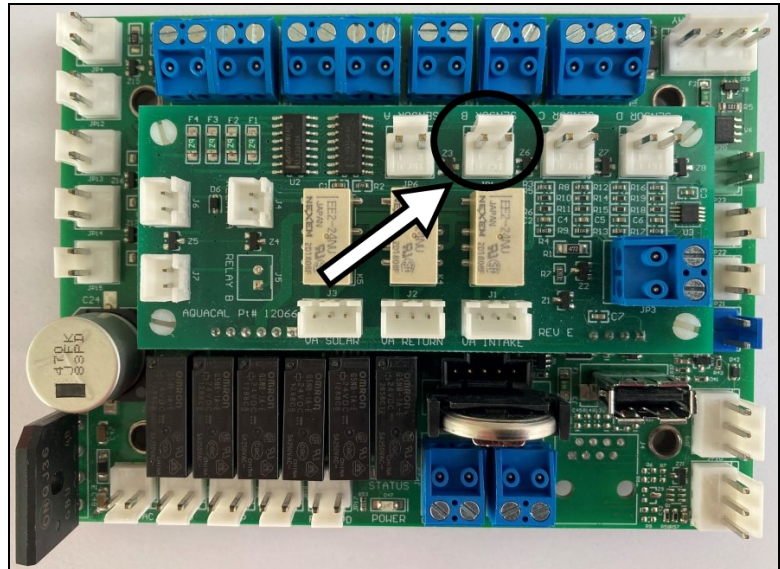

1.6.C Install Water Temperature Sensors for Solar Systems

The water temperature sensors must be moved in order to properly monitor the pool / spa water temperatures. If they are not moved, the solar system's higher temperature water will send a false signal to the heat pump that the temperature has been satisfied and the solar actuator and heat pump will repeatedly cycle on and off.

⚠ DANGER

Failure to heed the following will result in injury or death.

- Deactivate power while routing wiring to control board.
- RISK OF ELECTRICAL SHOCK FROM ENERGY STORED IN CAPACITORS - MODELS EQUIPPED WITH VARIABLE FREQUENCY COMPRESSOR DRIVES STORE ELECTRICITY EVEN AFTER THE POWER HAS BEEN DEACTIVATED AT THE POWER BREAKER. ***Wait for 2 minutes after the shut down of equipment before servicing.***
- Follow all National Electric Codes (NEC) and/or State and Local guidelines.

⚠ WARNING

Failure to heed the following may result in injury or death.

- This section is only for qualified installers who are familiar with the swimming pool and spa safety standards.
- The installer must be familiar with service industry techniques.

1. Turn off power at heat pump's power disconnect.
2. **Wait two minutes for capacitors to discharge before proceeding.**
3. Remove heat pump's electrical access panel.
4. Install two sensors after the filter and before the solar system's isolation valve. The sensors must be placed in the same location in the plumbing line. These sensors will allow a dual water temperature safety feature to function properly.
5. Route sensors wiring to the low voltage side of the electrical enclosure.
6. Connect one new sensor to port "AIR" on the main control board.
7. Connect the other sensor to the "C" port on the expansion board.
8. The sensor connected to "WS1" will remain in place.
9. Reattach heat pump access panel.

Connection Point's for Water Temperature Sensors

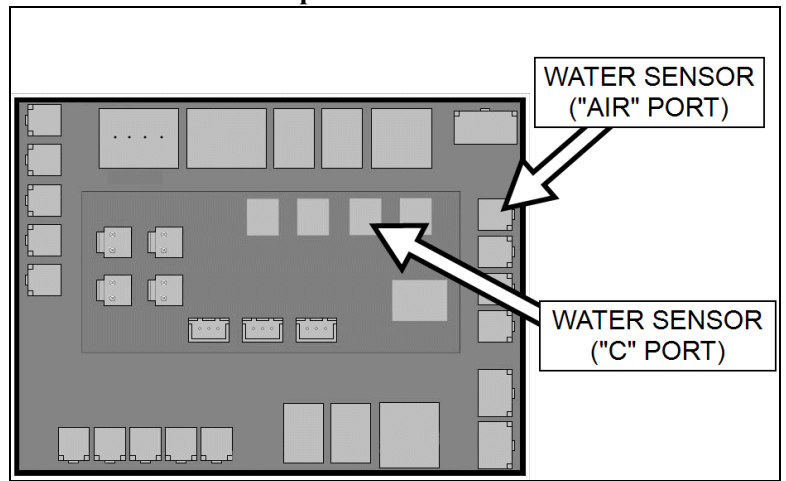

1.6.D Configuring Solar Control (Select Units)

IN THIS SECTION:

D.1 Activating Solar Control Feature	37
D.2 Manually Configure (Add) Solar Controller	38
D.3 Solar Controller Group Setup	39
D.4 Solar Control Mode	40
D.4.a Set Solar Control to ECO Mode	40
D.4.b Set Solar Control to HYBRID Mode	41
D.4.c Set Solar Control to SOLAR OFF	41
D.5 Set a desired temperature (setpoint) for the solar system to activate (Select Units)	42
D.6 Heat Pump Mode (Hybrid or OFF Only)	43
D.7 Solar Boost (ECO Mode Only)	43
D.8 Adjusting Solar Heating Differential	44
D.9 Adjusting Solar Cooling Differential	46
D.10 Solar Override	47
D.11 Viewing Solar Roof Temperature	48
D.12 Solar Heat / Cool Mode	49

D.1 Activating Solar Control Feature

Solar control needs to be enabled before the solar control options will be offered in the heat pump.

NOTE

A roof temperature sensor and a solar valve actuator are required in order to control the solar system. See "Connecting and Configuring a Solar Control System (Optional)" on page 33.

Enter "Advanced" menus, then proceed



IF UNIT IS ASLEEP, SWIPE TO WAKE UP



A PRESS MENU BUTTON



B USE ARROWS TO "SYSTEM"



C PRESS "ENTER"



D USE ARROWS TO "ADVANCED"



E PRESS "ENTER"



1 ARROWS TO "SOLAR CONTROL"



2 ENTER TO EDIT



3 ARROWS TO "SOLAR CONTROL ENABLED"



4 ENTER TO SELECT



5 ARROWS TO "ON"



6 ENTER TO SAVE



MENU TO EXIT, PRESS & HOLD TO STATUS



D.2 Manually Configure (Add) Solar Controller

In this example, the solar controller equipment is to be configured (Added).

Enter "Equipment" menus, then proceed

<p>IF UNIT IS ASLEEP, SWIPE TO WAKE UP</p> 	<p>A PRESS MENU BUTTON</p> 	<p>B USE ARROWS TO "EQUIPMENT"</p> 
<p>C PRESS "ENTER"</p> 	<p>1 USE ARROWS TO MENU "NEW EQUIPMENT"</p> 	<p>2 ENTER TO SELECT</p> 
<p>3 USE ARROWS TO "SOLAR CONTROLLER"</p> 	<p>4 ENTER TO SELECT</p> 	<p>5 USE ARROWS TO MENU DEVICE NAME</p> 
<p>6 ENTER TO SAVE</p> 	<p>7 USE ARROWS TO SOLAR CONTROLLER TYPE</p> 	<p>8 ENTER TO SAVE</p> 
<p>10 ENTER TO SELECT</p> 	<p>11 PRESS BUTTON UNDER "YES" TO SAVE</p> 	<p>MENU TO EXIT, PRESS & HOLD TO STATUS</p> 

- The configured device will now be available for insertion into a group.
 - See "Solar Controller Group Setup" on the next page.















D.3 Solar Controller Group Setup

A Solar Controller device is required in any group where a connected solar system is to be used. In the following example, the "POOL" group is edited to add the "Solar Controller".

NOTE

When setting up a heat pump using an installation preset, this device is added to groups by default.

Enter "Groups" menus, then proceed

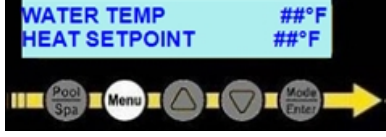
<p>IF UNIT IS ASLEEP, SWIPE TO WAKE UP</p> 	<p>A PRESS "MENU" BUTTON</p> 	<p>B USE ARROWS TO "GROUPS"</p> 
<p>C PRESS "ENTER"</p> 	<p>1 ARROWS TO "POOL GROUP"</p> 	<p>2 ENTER TO EDIT</p> 
<p>3 ARROWS TO "ADD EQUIPMENT"</p> 	<p>4 ENTER TO SELECT</p> 	<p>5 ARROWS TO "SOLAR CONTROL"</p> 
<p>6 ENTER TO SELECT</p> 	<p>7 ARROWS TO SELECT TEMPERATURE MODE</p> 	<p>8 ENTER TO SELECT</p> 
<p>9 ARROWS TO SELECT SET TEMPERATURE</p> 	<p>10 ENTER TO SAVE</p> 	<p>MENU TO EXIT, PRESS & HOLD TO STATUS</p> 

D.4 Solar Control Mode

Set the Solar Control mode. Available options are "ECO", "HYBRID", or "SOLAR OFF".

- **"ECO"**
 - In ECO (or economy) mode, the heat pump operation is disabled. Monitoring of the solar differences in temperature are made. The solar diverter valve actuator will activate as needed.
 - This is the maximum economical maintenance of the Pool / Spa water temperature by the solar system only.
 - A single water setpoint temperature is maintained by the user.
 - A solar boost mode is available to temporarily override this mode to bring water quickly to a desired temperature. See "*Solar Boost (ECO Mode Only)*" on page 43.
- **"HYBRID"**
 - In Hybrid mode, the heat pump and solar control work together to maintain the pool / spa water temperature within two setpoints. A heat pump setpoint and a solar setpoint (a minimum and maximum temperature).
 - The heat pump is typically used to maintain the minimum setpoint, while solar control maintains the maximum setpoint.
- **"SOLAR OFF"**
 - Solar control is disabled. This is the default setting from the factory.
 - When in this state, the valve actuator will rotate to the solar off position.
 - Unless the manual override feature is enabled. Water is diverted through the heat pump only.

D.4.a Set Solar Control to ECO Mode

Enter "Shortcuts" menus, then proceed

IF UNIT IS ASLEEP, SWIPE TO WAKE UP

A PRESS MENU BUTTON

B USE ARROWS TO "SHORTCUTS"

C PRESS "ENTER"

1 ARROWS TO "SOLAR CONTROL MODE"

2 ENTER TO EDIT









3 USE ARROWS TO CHANGE

4 ENTER TO SAVE

MENU TO EXIT, PRESS & HOLD TO STATUS





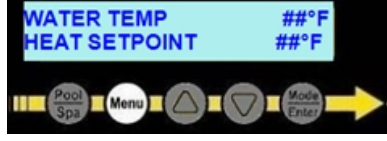



D.4.b Set Solar Control to HYBRID Mode

Enter "Shortcuts" menus, then proceed

<p>IF UNIT IS ASLEEP, SWIPE TO WAKE UP</p> 	<p>A PRESS MENU BUTTON</p> 	<p>B USE ARROWS TO "SHORTCUTS"</p> 
<p>C PRESS "ENTER"</p> 	<p>1 ARROWS TO "SOLAR CONTROL MODE"</p> 	<p>2 ENTER TO EDIT</p> 
<p>3 USE ARROWS TO CHANGE</p> 	<p>4 ENTER TO SAVE</p> 	<p>MENU TO EXIT, PRESS & HOLD TO STATUS</p> 

D.4.c Set Solar Control to SOLAR OFF

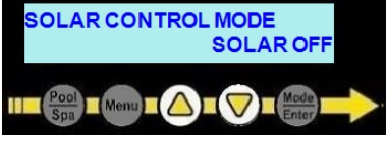
Enter "Shortcuts" menus, then proceed

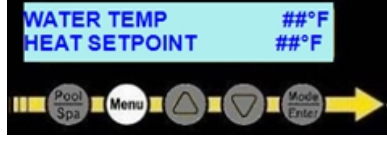
<p>IF UNIT IS ASLEEP, SWIPE TO WAKE UP</p> 	<p>A PRESS MENU BUTTON</p> 	<p>B USE ARROWS TO "SHORTCUTS"</p> 
<p>C PRESS "ENTER"</p> 	<p>1 ARROWS TO "SOLAR CONTROL MODE"</p> 	<p>2 ENTER TO EDIT</p> 
<p>3 USE ARROWS TO CHANGE</p> 	<p>4 ENTER TO SAVE</p> 	<p>MENU TO EXIT, PRESS & HOLD TO STATUS</p> 







D.5 Set a desired temperature (setpoint) for the solar system to activate (Select Units)

PLEASE NOTE
 Setting a water temperature setpoint for the solar system is only useful if the SOLAR CONTROL MODE is set to "HYBRID" or "ECO" mode. See "Solar Control Mode" on page 40.

- ALSO NOTE:**
- The maximum temperature the Solar System can be set towards is 104° F (40° C).
 - The solar system will be set to off if incoming water temperatures are above 108° F (42° C). This assumes the heat pump is controlling the solar system and it was installed as recommended.

Example:

The solar system is set from 78° F to 80° F.

<p>A PRESS MENU BUTTON</p> 	<p>B USE ARROWS TO "SHORTCUTS"</p> 	<p>C PRESS "ENTER"</p> 
<p>1 USE ARROWS TO SOLAR SETPOINT</p> 	<p>2 ENTER TO EDIT</p> 	<p>3 ARROWS TO CHANGE</p> 
<p>4 ENTER TO SAVE</p> 		

D.6 Heat Pump Mode (Hybrid or OFF Only)

Set the Heat Pump's mode. Available options are "HEAT SETPOINT" or "OFF".

Press "Mode / Enter" button until the desired mode is displayed.

- HEAT SETPOINT - Used to activate heat pump's heating mode. If the heat pump's setpoint is below the Pool or Spa water temperature, the fan and compressor will start, then the red "Heating" light will activate.
- OFF - The heat pump will indicate it is deactivated. The current water temperature will be displayed.

PLEASE NOTE:

This mode does not control the solar control mode. See "Solar Control Mode" on page 40.



D.7 Solar Boost (ECO Mode Only)

Solar Boost allows the user to temporarily override the "ECO" mode to rapidly bring the water temperature to the solar temperature setpoint.

- The option activates the heat pump and solar system at the same time.
- When boost is activated, the heat pump setpoint is automatically changed to match the solar setpoint. The equipment operates together towards a single target setpoint
- Once the pool / spa water temperature reaches the setpoint, the system falls back into the ECO mode.

NOTE

- This mode is only available if the solar control has been set to the "ECO" mode. See "Solar Control Mode" on page 40.

Activating Solar Boost

Enter "Shortcuts" menus, then proceed

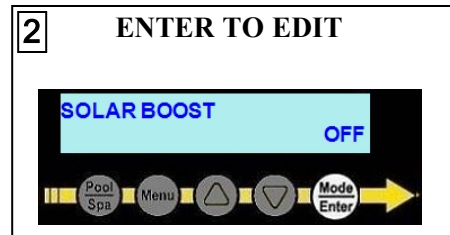
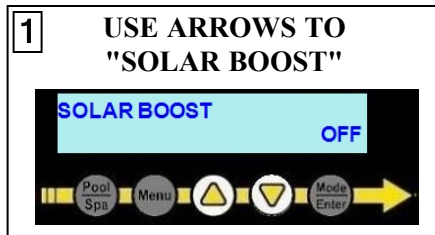
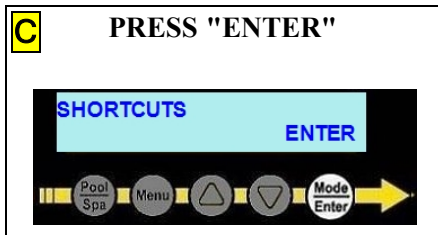
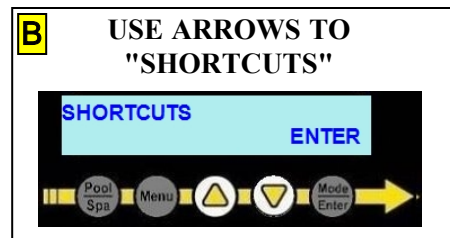
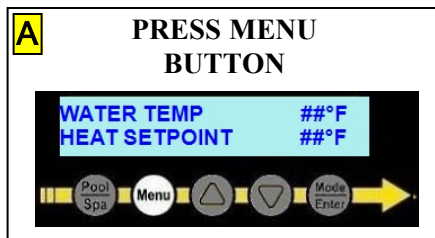
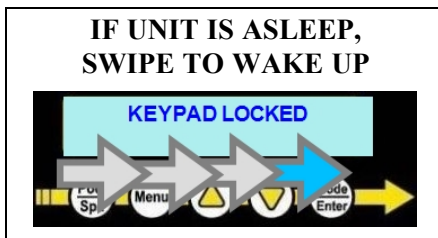

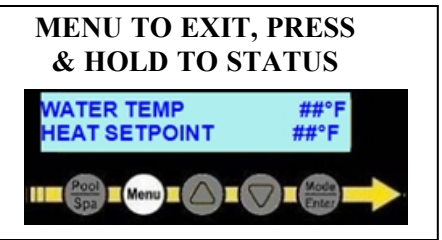
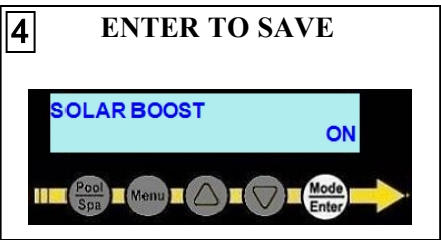

D.8 Adjusting Solar Heating Differential

In general, the water flowing through the solar collectors is used to heat the pool / spa water. The unit will call for heating when the solar setpoint is higher than the existing pool / spa water temperature.

- Heating starts when the roof temperature is 6° F greater than the water temperature of the pool or spa.
- Heating stops when the roof temperature is within 2° F of the water temperature of the pool or spa.
- Please note - the Heat Pump solar settings must be as follows:
 - The "SOLAR CONTROL MODE" is set to "ECO" mode. See "Solar Control Mode" on page 40.
 - The "SOLAR HEAT / COOL MODE" is set to "HEAT" or "AUTO". See "Solar Heat / Cool Mode" on page 49.

Enter "Solar Advanced" menus, then proceed

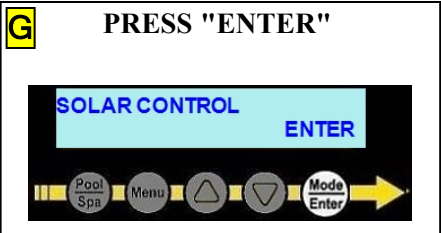
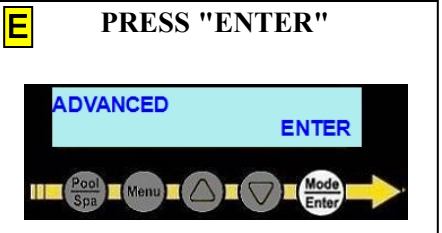
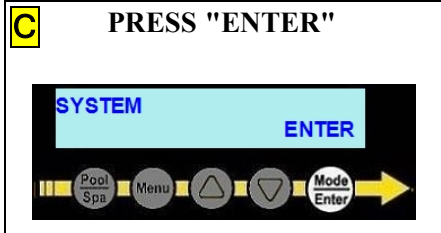
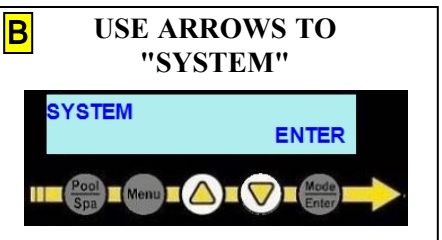
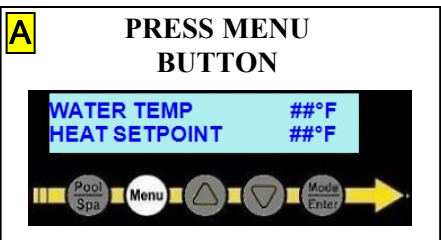
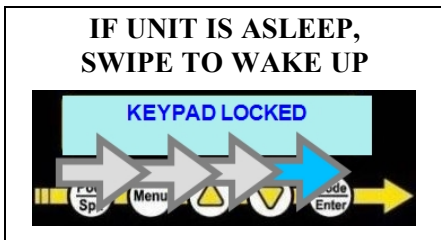

1 PRESS "ENTER"

SOLAR ADVANCED ENTER

Pool Spa Menu Up Arrow Down Arrow Mode Enter

1 USE ARROWS TO "HEAT ON DIFFERENTIAL"

HEAT ON DIFFERENTIAL 6.0° F

Pool Spa Menu Up Arrow Down Arrow Mode Enter

2 ENTER TO EDIT

HEAT ON DIFFERENTIAL 6.0° F

Pool Spa Menu Up Arrow Down Arrow Mode Enter

3 USE ARROWS TO CHANGE

HEAT ON DIFFERENTIAL 5.0° F

Pool Spa Menu Up Arrow Down Arrow Mode Enter

4 ENTER TO SAVE

HEAT ON DIFFERENTIAL 5.0° F

Pool Spa Menu Up Arrow Down Arrow Mode Enter

5 ARROWS TO "HEAT OFF DIFFERENTIAL"

HEAT OFF DIFFERENTIAL 2.0° F

Pool Spa Menu Up Arrow Down Arrow Mode Enter

6 ENTER TO EDIT

HEAT OFF DIFFERENTIAL 2.0° F

Pool Spa Menu Up Arrow Down Arrow Mode Enter

7 USE ARROWS TO CHANGE

HEAT OFF DIFFERENTIAL 3.0° F

Pool Spa Menu Up Arrow Down Arrow Mode Enter

8 ENTER TO SAVE

HEAT OFF DIFFERENTIAL 3.0° F

Pool Spa Menu Up Arrow Down Arrow Mode Enter

MENU TO EXIT, PRESS & HOLD TO STATUS

WATER TEMP ##°F
HEAT SETPOINT ##°F

Pool Spa Menu Up Arrow Down Arrow Mode Enter

D.9 Adjusting Solar Cooling Differential

The water flowing through the solar collectors can be used to cool the pool / spa water. The unit will call for cooling when the solar setpoint is lower than the existing pool / spa water temperature.

- Cooling starts when the roof temperature is 8° F less than the water temperature of the pool or spa.
- Cooling stops when the roof temperature is within 3° F of the water temperature of the pool or spa.
- Please note - the Heat Pump solar settings must be as follows:
 - The "SOLAR CONTROL MODE" is set to "ECO" mode. See "Solar Control Mode" on page 40.
 - The "SOLAR HEAT / COOL MODE" is set to "COOL" or "AUTO". See "Solar Heat / Cool Mode" on page 49.

Enter "Solar Advanced" menus, then proceed

<p>IF UNIT IS ASLEEP, SWIPE TO WAKE UP</p> 	<p>A PRESS MENU BUTTON</p> 	<p>B USE ARROWS TO "SYSTEM"</p> 
<p>C PRESS "ENTER"</p> 	<p>D USE ARROWS TO "ADVANCED"</p> 	<p>E PRESS "ENTER"</p> 
<p>F USE ARROWS TO "SOLAR CONTROL"</p> 	<p>G PRESS "ENTER"</p> 	<p>H USE ARROWS TO "SOLAR ADVANCED"</p> 
<p>I PRESS "ENTER"</p> 	<p>1 USE ARROWS TO "COOL ON DIFFERENTIAL"</p> 	<p>2 ENTER TO EDIT</p> 
<p>3 USE ARROWS TO CHANGE</p> 	<p>4 ENTER TO SAVE</p> 	<p>5 ARROWS TO "COOL OFF DIFFERENTIAL"</p> 

6 ENTER TO EDIT

7 USE ARROWS TO CHANGE

8 ENTER TO SAVE CHANGE

MENU TO EXIT, PRESS & HOLD TO STATUS

D.10 Solar Override

The solar system valve can be forced "ON" to allow an installer to check for leaks in the solar collectors. The time the valve is overridden can be adjusted from 5 to 30 minutes. The default time is 15 minutes.

Enter "Solar Advanced" menus, then proceed

IF UNIT IS ASLEEP, SWIPE TO WAKE UP

A PRESS MENU BUTTON

B USE ARROWS TO "SYSTEM"

C PRESS "ENTER"

D USE ARROWS TO "ADVANCED"

E PRESS "ENTER"

F USE ARROWS TO "SOLAR CONTROL"

G PRESS "ENTER"

H USE ARROWS TO "SOLAR ADVANCED"

I PRESS "ENTER"

1 USE ARROWS TO "OVERRIDE DELAY"

2 ENTER TO EDIT

3 USE ARROWS TO CHANGE

4 ENTER TO SAVE

5 ARROWS TO "OVERRIDE ENABLE"

6 ENTER TO EDIT

7 USE ARROWS TO CHANGE

8 ENTER TO SAVE

9 USE ARROWS TO "OVERRIDE ENABLE"

10 ENTER TO EDIT

11 ARROWS TO CHANGE TO "ON"

12 ENTER TO SAVE

MENU TO EXIT, PRESS & HOLD TO STATUS

D.11 Viewing Solar Roof Temperature

A sensor located on the roof can measure the roof's air temperature. This approximates the heating or cooling potential of the water in the solar panels on the roof. This menu is a status screen and can not be edited.

Enter "Shortcuts" menus, then proceed

IF UNIT IS ASLEEP, SWIPE TO WAKE UP

A PRESS MENU BUTTON

B USE ARROWS TO "SHORTCUTS"

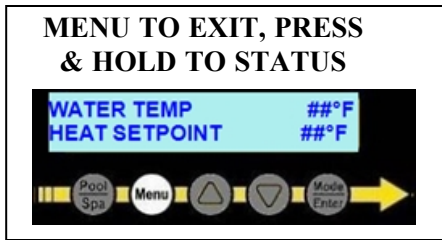
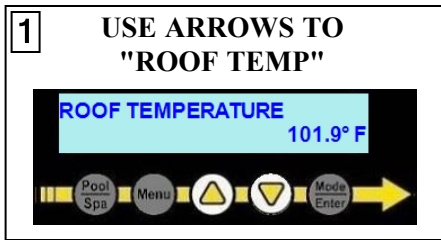
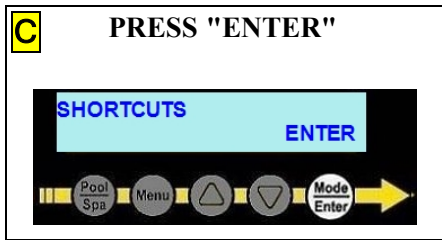

D.12 Solar Heat / Cool Mode

The user can set the Solar Heat Cool mode if necessary. Available options are "HEAT", "COOL", or "AUTO". The default mode from the factory is "HEAT". It is advised that this mode match the heat pump's mode button setting.

In the following example, the Solar Heat / Cool Mode is reset from "HEAT" to "COOL".

Enter "Solar Advanced" menus, then proceed

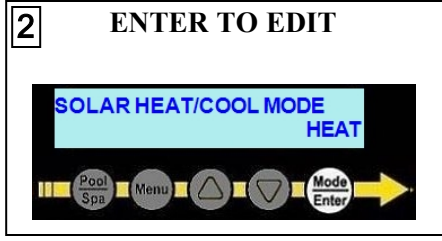
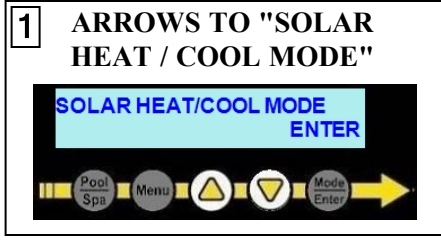
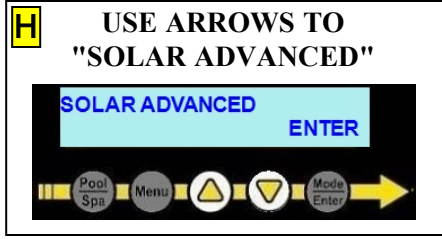
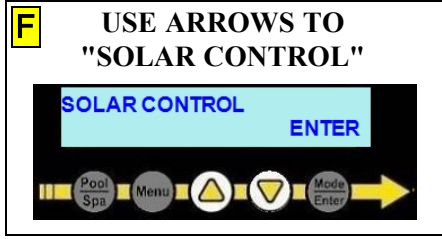
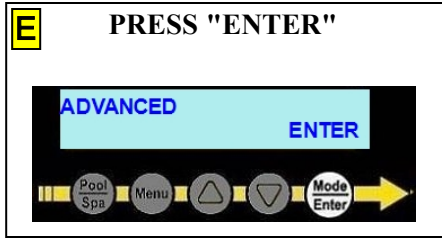
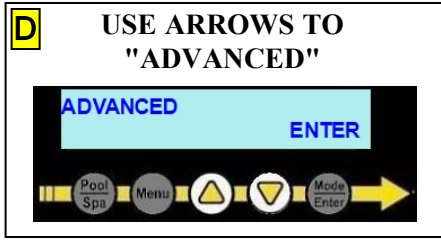
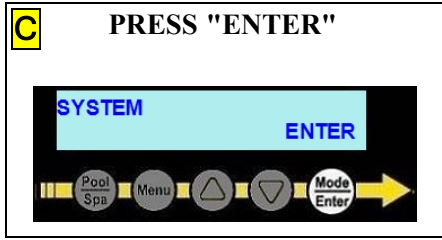
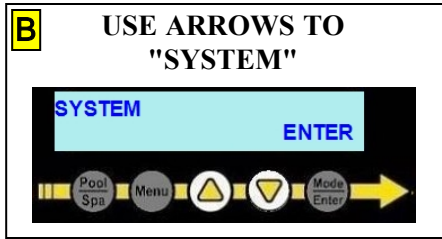
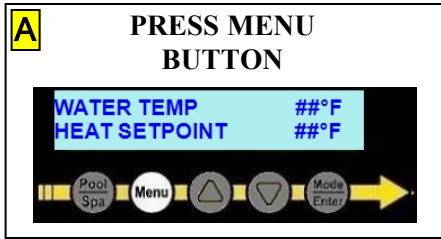
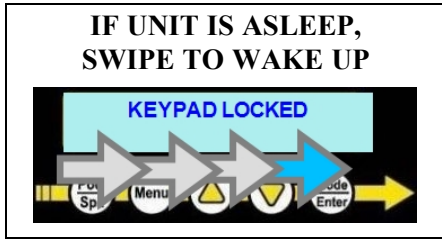

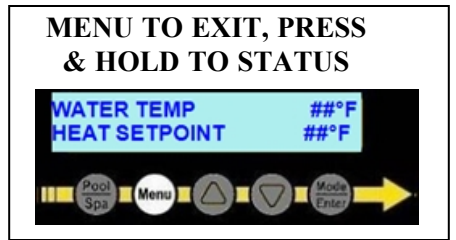
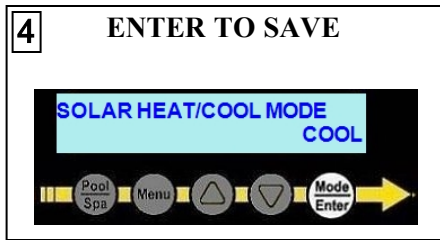
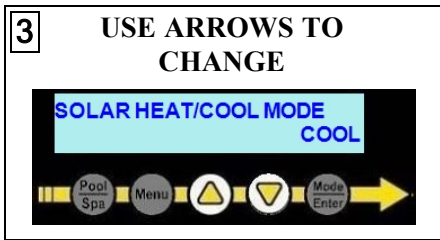

1.7 Connecting Multiple Heat Pumps (Optional)

Up to 16 heat pumps can be connected and controlled from a primary heat pump.

There are two reasons for using a multiple heat pump configuration:

1. Controlling multiple heat pumps from one location; the primary heat pump.
2. Preventing heat pumps from starting up at the same time and causing an excessive power draw on the electric circuit.

NOTICE

Failure to heed the following may result in damage to equipment.

- The wire size connecting the heat pumps must be 22-gauge, 3-conductor, shielded, outdoor rated wire. Be sure that the size of the wire will allow at least three wires per connection point.
- Do not attempt to connect heat pump equipment in multiple configurations with previous HP7 and HP7R versions of the control board. See Figure 7. No onboard port is provided for heat pumps with these control board versions. An Automatic Sequencing Controller (ASC) accessory is required for those types of heat pumps.

**DO NOT
CONNECT
HP7 or HP7R
boards**

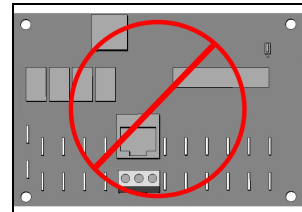

Figure 7

IN THIS SECTION:

1.7.A Connecting Heat Pumps	50
1.7.B Configure Primary Heat Pump	51
1.7.C Configure Secondary Heat Pumps	52

1.7.A Connecting Heat Pumps

1. Choose one unit to be the lead (or primary) unit. This is typically a unit that can be accessed easily when temperature adjustments are needed.
 - Note - The primary unit can be connected to an external controller via the controller (PORT B) connection point if desired.
2. Deactivate power to heat pumps.
3. Remove electrical access panels.
4. Route 22-gauge, 3-conductor, shielded, outdoor rated wires to the low voltage sides of the electrical enclosures. Follow all National Electric Codes (NEC) and / or State and Local guidelines.

RS-485 Connection Points (Dry Contact)

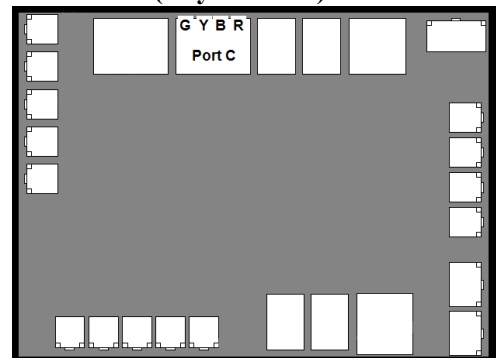

Figure 8

5. Connect the first secondary heat pump's wires to the unit selected as the primary heat pump's.
6. Use "Port C" on the control boards as indicated. Connecting the "G" to "G", the "Y" to "Y", and the "B" to "B" on each heat pump's port "C" connection point. ***The "R" connection points are not used.*** See Figure 8.
7. Connect any additional heat pumps as indicated, doubling up the wires as shown. See Figure 9. Confirm the same color wires connect to the same wires on each heat pump ("G" to "G", "Y" to "Y", and "B" to "B"). Up to 16 heat pumps can be controlled by one heat pump.
8. Label the heat pumps appropriately as a primary unit and secondary units (Primary, Secondary 01, Secondary 02, etc.) to simplify configuration and future operation.
9. Reattach access panels.

**Multiple Heat Pump
Connection Points to "Port C"**

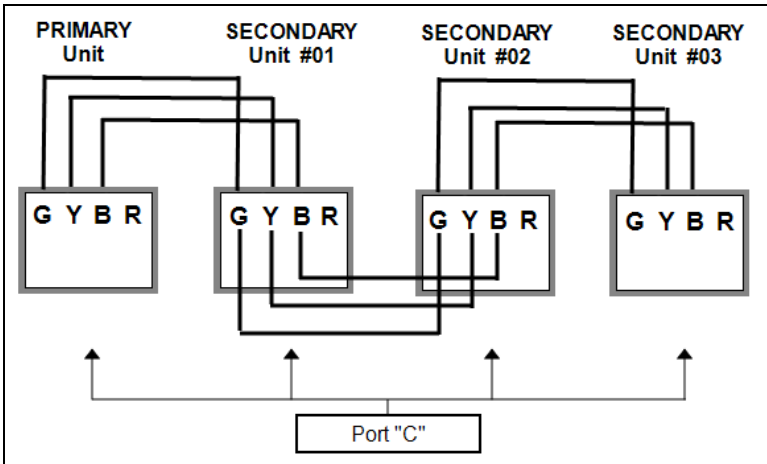

Figure 9





10. Apply power to primary heat pump. Confirm the mode is set to " **HEAT PUMP OFF**".
11. Apply power to the next heat pump and confirm the mode is set to " **HEAT PUMP OFF**". Do this for each heat pump.
12. Program heat pumps with assigned addresses. See "Connecting Multiple Heat Pumps (Optional)" on the previous page.

1.7.B Configure Primary Heat Pump

Confirm the first connected heat pump is designated as the primary unit.

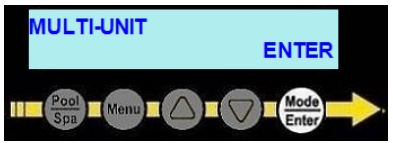
Enter "Advanced" menus, then proceed

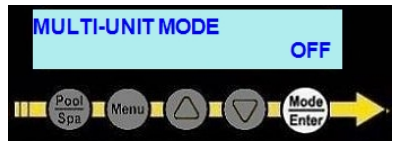
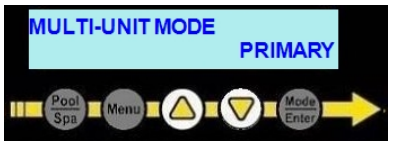
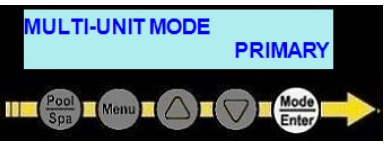





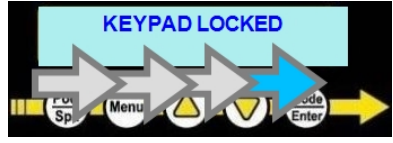

<p>IF UNIT IS ASLEEP, SWIPE TO WAKE UP</p>	<p>A PRESS MENU BUTTON</p>	<p>B USE ARROWS TO "SYSTEM"</p>
<p>C PRESS "ENTER"</p>	<p>D USE ARROWS TO "ADVANCED"</p>	<p>E PRESS "ENTER"</p>

<p>1 USE ARROWS TO "MULTI-UNIT"</p> 	<p>2 ENTER TO EDIT</p> 	<p>3 USE ARROWS TO "MULTI-UNIT MODE"</p> 
<p>4 ENTER TO EDIT</p> 	<p>5 USE ARROWS TO CHANGE TO "PRIMARY"</p> 	<p>6 ENTER TO SAVE</p> 
<p>MENU TO EXIT, PRESS & HOLD TO STATUS</p> 		

1.7.C Configure Secondary Heat Pumps

Go to the next connected heat pump and configure it as a secondary unit with a heat pump address of "01". Each additionally connected heat pump will require a unique heat pump address ("02", "03", etc.)

Enter "Advanced" menus, then proceed

<p>IF UNIT IS ASLEEP, SWIPE TO WAKE UP</p> 	<p>A PRESS MENU BUTTON</p> 	<p>B USE ARROWS TO "SYSTEM"</p> 
<p>C PRESS "ENTER"</p> 	<p>D USE ARROWS TO "ADVANCED"</p> 	<p>E PRESS "ENTER"</p> 
<p>1 USE ARROWS TO "MULTI-UNIT"</p> 	<p>2 PRESS ENTER TO EDIT</p> 	<p>3 USE ARROWS TO "MULTI-UNIT MODE"</p> 

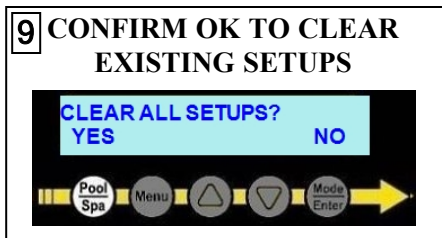
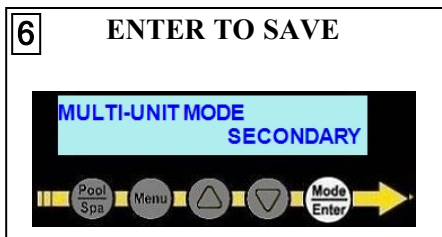
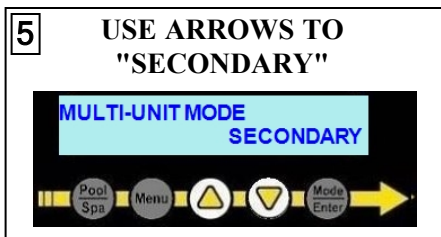
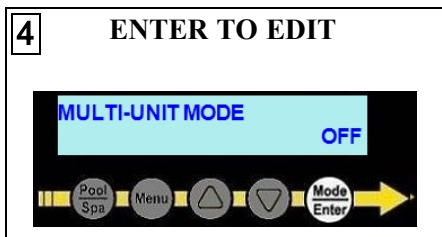

PLEASE NOTE:
 This action will wipe all previous settings in favor of the new configuration. This includes external controller settings, optional device settings, groups, equipment, schedules, and site specific settings. Additional site specific settings may need to be put in place.

The system will restart. The heat pump will now need to be controlled by the primary heat pump.

1.8 Programming

IN THIS SECTION:

1.8.A Setting Date and Time	54
1.8.B Setting Date and Time Format	54
1.8.C Selecting Celsius or Fahrenheit	55
1.8.D Set a desired temperature (setpoint) for the solar system to activate (Select Units)	56
1.8.E Set a desired temperature (setpoint) for the Heat Pump to activate	57
1.8.F Setting Entry Code Option	58
1.8.G Disabling Entry Code Option	59
1.8.H Site Configuration Presets (Optional)	60
1.8.I Configuring Groups	65
I.1 Create a Group	66
I.2 Edit a Group	67
I.3 Delete a Group	68
1.8.J Configuring Schedules	69
J.1 Create a Schedule	69
J.2 Edit a Schedule	71
J.3 Delete a Schedule	72
1.8.K Schedule and Program Modes	73
1.8.L Using Shortcuts	78

1.8.A Setting Date and Time



The date and time are required in order to allow schedules to operate properly.

Set the heat pump's date and time using the following steps.

PLEASE NOTE:

If a PoolSync[®] device is attached and in-use, the time and date will automatically be set and maintained.

Enter "System" menus, then proceed

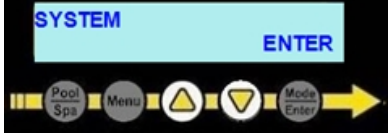
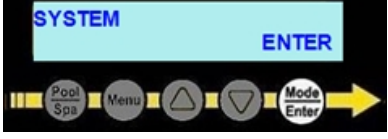
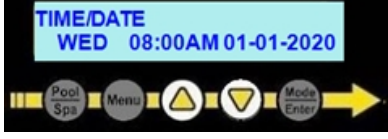
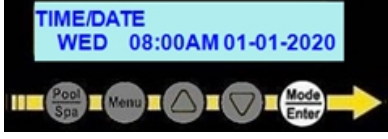
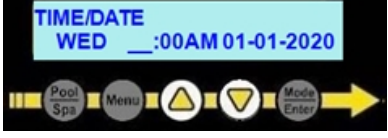
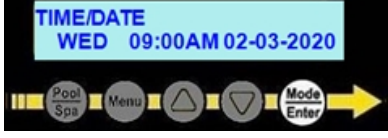
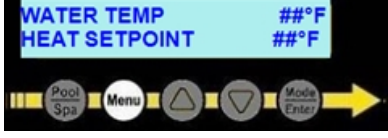
<p>IF UNIT IS ASLEEP, SWIPE TO WAKE UP</p> 	<p>A PRESS MENU BUTTON</p> 	<p>B USE ARROWS TO "SYSTEM"</p> 
<p>C PRESS "ENTER"</p> 	<p>1 USE ARROWS TO MENU "TIME / DATE"</p> 	<p>2 PRESS ENTER, ITEM TO CHANGE WILL BLINK</p> 
<p>3 USE ARROWS TO CHANGE</p> 	<p>4 ENTER TO SAVE</p> 	<p>MENU TO EXIT, PRESS & HOLD TO STATUS</p> 



1.8.B Setting Date and Time Format





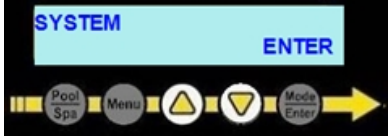

The heat pump's date and time format can be customized.

Customize Time

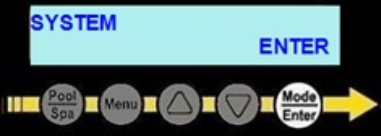
The time can be displayed in 24-hour *military* time (the default display is 12-hour).

Enter "System" menus, then proceed









<p>IF UNIT IS ASLEEP, SWIPE TO WAKE UP</p> 	<p>A PRESS MENU BUTTON</p> 	<p>B USE ARROWS TO "SYSTEM"</p> 
-------------------------------------------------------------------------------------------------------------------------------------------	----------------------------------------------------------------------------------------------------------------------------	----------------------------------------------------------------------------------------------------------------------------------

<p>C PRESS "ENTER"</p> 	<p>1 USE ARROWS TO MENU "TIME FORMAT"</p> 	<p>2 ENTER TO EDIT</p> 
<p>3 USE ARROWS TO CHANGE</p> 	<p>4 ENTER TO SAVE</p> 	<p>MENU TO EXIT, PRESS & HOLD TO STATUS</p> 

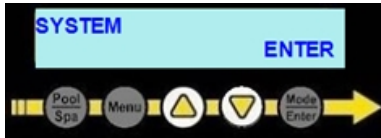
Customize Date

The date can be displayed as Day-Month-Year (the default is Month-Day-Year).

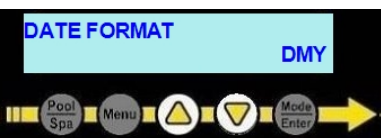

Enter "System" menus, then proceed





<p>IF UNIT IS ASLEEP, SWIPE TO WAKE UP</p> 	<p>A PRESS MENU BUTTON</p> 	<p>B USE ARROWS TO "SYSTEM"</p> 
<p>C PRESS "ENTER"</p> 	<p>1 USE ARROWS TO MENU "DATE FORMAT"</p> 	<p>2 ENTER TO EDIT</p> 
<p>3 USE ARROWS TO CHANGE</p> 	<p>4 ENTER TO SAVE</p> 	<p>MENU TO EXIT, PRESS & HOLD TO STATUS</p> 

1.8.C Selecting Celsius or Fahrenheit

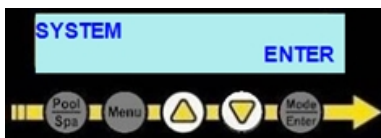
Set the water temperature to show in either Fahrenheit (default) or Celsius.

Enter "System" menus, then proceed

<p>IF UNIT IS ASLEEP, SWIPE TO WAKE UP</p> 	<p>A PRESS MENU BUTTON</p> 	<p>B USE ARROWS TO "SYSTEM"</p> 
--------------------------------------------------------------------------------------------------------------------------------	-----------------------------------------------------------------------------------------------------------------------	------------------------------------------------------------------------------------------------------------------------------

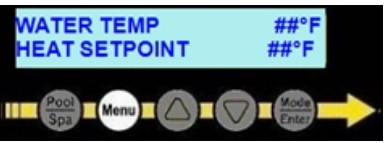



C PRESS "ENTER" 	1 USE ARROWS TO "TEMPERATURE UNITS" 	2 ENTER TO EDIT 
3 USE ARROWS TO CHANGE 	4 ENTER TO SAVE 	MENU TO EXIT, PRESS & HOLD TO STATUS 

1.8.D Set a desired temperature (setpoint) for the solar system to activate (Select Units)

PLEASE NOTE
 Setting a water temperature setpoint for the solar system is only useful if the SOLAR CONTROL MODE is set to "HYBRID" or "ECO" mode. See "Solar Control Mode" on page 40.

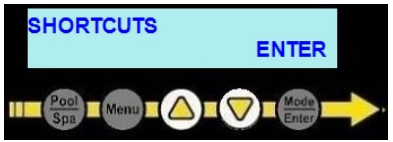
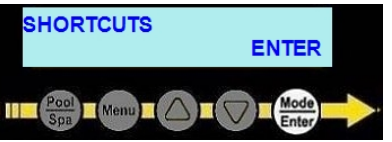
- ALSO NOTE:**
- The maximum temperature the Solar System can be set towards is 104° F (40° C).
 - The solar system will be set to off if incoming water temperatures are above 108° F (42° C). This assumes the heat pump is controlling the solar system and it was installed as recommended.

Example:
 The solar system is set from 78° F to 80° F.

A PRESS MENU BUTTON 	B USE ARROWS TO "SHORTCUTS" 	C PRESS "ENTER" 
1 USE ARROWS TO SOLAR SETPOINT 	2 ENTER TO EDIT 	3 ARROWS TO CHANGE 
4 ENTER TO SAVE 		

1.8.E Set a desired temperature (setpoint) for the Heat Pump to activate

PLEASE NOTE

Setting a water temperature setpoint for the heat pump is only useful if the SOLAR CONTROL MODE is set to "HYBRID" or the "SOLAR OFF" mode. See "Solar Control Mode" on page 40.

- The heat pump is typically used to maintain a minimum water temperature.
- The solar system would typically be set to maintain a maximum water temperature.

Example:

A heat pump is set to 78° F and the solar system is set to 80° F.

- The heat pump would deactivate when the water reaches 78° F.
- The solar system would deactivate when the water temperature reaches 80° F.

Press the up or down arrow to set the desired temperature (setpoint) for the water.

- The heating indicator will illuminate when heating the water.
- The cooling indicator will illuminate when cooling the water.

PLEASE NOTE:

- The maximum temperature the Heat Pump can be set towards is 104° F (40° C).

PLEASE NOTE:

The heat pump will not operate if incoming water temperatures are above 110° F (43° C). If sustained water temperatures will fall below 32° F (0° C), the equipment must be winterized in order to prevent damage. See "Winterizing" on page 106.

NOTE:

If a group's schedule is active and the temperature setpoint is changed, that group's temperature setpoint will also be changed.

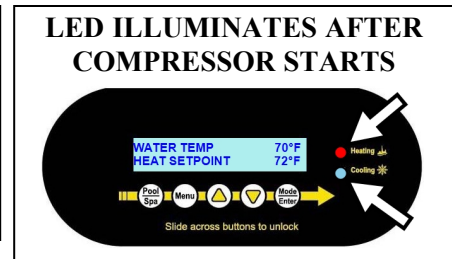
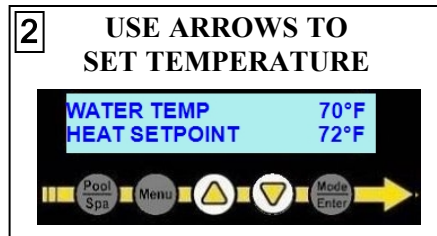
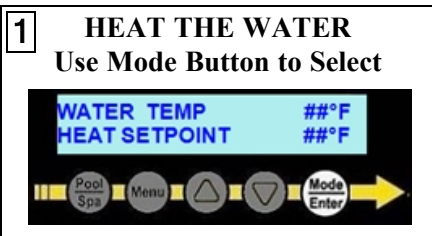

1.8.F Setting Entry Code Option









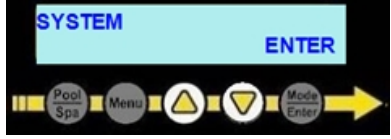
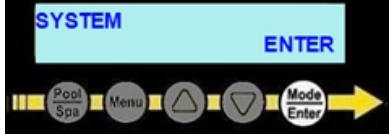
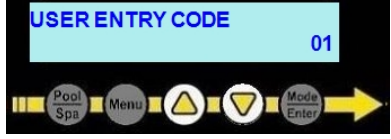

The entry code feature can prevent unauthorized access to the heat pump adjustments. This feature initiates after the heat pump goes into the sleep mode for the first time. This feature is commonly used on commercial applications.

NOTICE

Failure to heed the following may result in damage to equipment.

- **Before enabling the entry code feature, be sure to record the code.** If lost, the heat pump will require a program reset to regain access. This reset may require additional configuration by the installer.

Enter "System" menus, then proceed



<p>IF UNIT IS ASLEEP, SWIPE TO WAKE UP</p> 	<p>A PRESS MENU BUTTON</p> 	<p>B USE ARROWS TO "SYSTEM"</p> 
<p>C PRESS "ENTER"</p> 	<p>1 USE ARROWS TO MENU "USER ENTRY CODE"</p> 	<p>2 ENTER TO EDIT</p> 
<p>3 USE ARROWS TO CHANGE</p> 	<p>4 ENTER TO SAVE</p> 	<p>5 USE ARROWS TO MENU "USER CODE ENABLED"</p> 
<p>6 ENTER TO EDIT</p> 	<p>7 USE ARROWS TO CHANGE</p> 	<p>8 ENTER TO SAVE</p> 
<p>MENU TO EXIT, PRESS & HOLD TO STATUS</p> 		

1.8.G Disabling Entry Code Option





PLEASE NOTE -

- If an entry code has already been activated, the code must be entered before proceeding to disable.

Use Entry Code

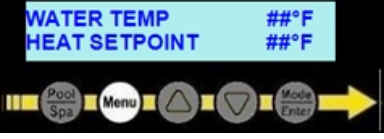
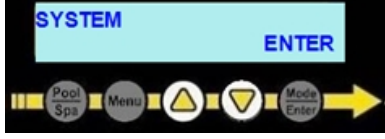
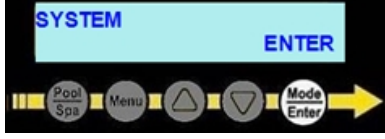
<p>IF UNIT IS ASLEEP, SWIPE TO WAKE UP</p> 	<p>1 USE ARROWS TO ENTER CODE</p> 	<p>2 ENTER TO UNLOCK</p> 
-------------------------------------------------------------------------------------------------------------------------------------	----------------------------------------------------------------------------------------------------------------------------	---------------------------------------------------------------------------------------------------------------------

Disable User Lock

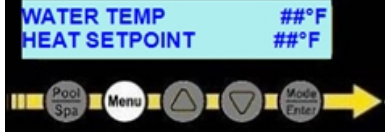
<p>A PRESS MENU BUTTON</p> 	<p>B USE ARROWS TO "SYSTEM"</p> 	<p>C PRESS "ENTER"</p> 
<p>3 USE ARROWS TO "USER ENTRY CODE ENABLED"</p> 	<p>4 ENTER TO EDIT</p> 	<p>5 ARROWS TO CHANGE</p> 
<p>6 ENTER TO SAVE</p> 	<p>MENU TO EXIT, PRESS & HOLD TO STATUS</p> 	

1.8.H Site Configuration Presets (Optional)

A list of site configurations (presets) can be used to easily configure equipment directly connected to the heat pump. Connected equipment, such as a circulation pump for example, can have all the necessary options automatically set to operate the device.

NOTICE

Failure to heed the following may result in damage to equipment.

- Any existing programs or settings will be cleared and replaced with the chosen preset option. If this is undesired, then press the button under "SKIP" to exit the wizard and set up equipment manually.
- After using a preset, values such as system RPMs should be checked to confirm they do not exceed system requirements. Damage to equipment due to excessive water flow, from setting RPMs too high, is not covered under factory warranties.

NOTE

After using a preset, any setting can be manually customized (or fine tuned) by the installer. Values, such as circulation pump RPMs, should be checked to confirm they do not exceed system requirements.

ALSO NOTE

- If necessary, the system can be set to factory default if an incorrect preset has been used. See "Factory Reset" on page 91.
- If a third-party external controller was used prior to upgrading the system, a factory reset will be required to see all presets. See "Factory Reset" on page 91.
- If the PoolSync[®] external controller was used prior to upgrading the system, all applicable heat pump presets will be shown.

Navigate to the installation menus to access these preset configurations.

A PRESS MENU BUTTON

WATER TEMP ##°F
HEAT SETPOINT ##°F

Pool Spa Menu Mode Enter

B USE ARROWS TO "SYSTEM"

SYSTEM ENTER

Pool Spa Menu Mode Enter

C PRESS "ENTER"

SYSTEM ENTER

Pool Spa Menu Mode Enter

D USE ARROWS TO "ADVANCED"

ADVANCED ENTER

Pool Spa Menu Mode Enter

E PRESS "ENTER"

ADVANCED ENTER

Pool Spa Menu Mode Enter

F USE ARROWS TO "INSTALLATION"

INSTALLATION ENTER

Pool Spa Menu Mode Enter

G PRESS "ENTER"

INSTALLATION ENTER

Pool Spa Menu Mode Enter

Select the appropriate preset for the site conditions.

PRESET OPTIONS:

Pool / Spa, No Pump	61
Pool / Spa, Pentair VS	61
Pool / Spa, Hayward VS	62
Pool / Spa, Jandy VS	62
Pool Only, No Pump	62
Pool Only, Pentair VS	62
Pool Only, Hayward VSS	63
Pool Only, Jandy VS	63
Spa Only, No Pump	63
Spa Only, Pentair VS	63
Spa Only, Hayward VS	64
Spa Only, Jandy VS	64
Use Setup from USB	65

Pool / Spa, No Pump

**POOL / SPA
NO PUMP** **SELECT**

This preset configures the heat pump as follows:

- No circulation pump is configured.
- No schedules are configured.

When pressed, the "Pool/Spa" button will display with three choices:

1. Pool - With an initial timer set for 48 hours at 85° F.
2. Spa - With an initial timer of 2 hours at 104° F.
3. Schedules - Without an active schedule, the heat pump mode is initially set to "OFF".

Pool / Spa, Pentair VS

**POOL / SPA
PENTAIR VS** **SELECT**

This preset configures the heat pump as follows:

- A Pentair (or Sta-Rite) variable speed circulation pump is configured.
- A pool schedule is configured (Everyday from 8:00 am to 6:00 pm)

When pressed, the "Pool/Spa" button will display with three choices.

1. Pool - With an initial timer set for 48 hours at 85° F.
2. Spa - With an initial timer of 2 hours at 104° F.
3. Schedules

Pool / Spa, Hayward VS

**POOL / SPA
HAYWARD VS** **SELECT**

This preset configures the heat pump as follows:

- A Hayward variable speed circulation pump is configured.
- A pool schedule is configured (Everyday from 8:00 am to 6:00 pm)

When pressed, the "Pool/Spa" button will display with three choices.

1. Pool - With an initial timer set for 48 hours at 85° F.
2. Spa - With an initial timer of 2 hours at 104° F.
3. Schedules

Pool / Spa, Jandy VS

**POOL / SPA
JANDY VS** **SELECT**

This preset configures the heat pump as follows:

- A Jandy variable speed circulation pump is configured.
- A pool schedule is configured (Everyday from 8:00 am to 6:00 pm)

When pressed, the "Pool/Spa" button will display with three choices.

1. Pool - With an initial timer set for 48 hours at 85° F.
2. Spa - With an initial timer of 2 hours at 104° F.
3. Schedules

Pool Only, No Pump

**POOL ONLY
NO PUMP** **SELECT**

This preset configures the heat pump as follows:

- No circulation pump is configured.
- No schedules are configured.

When pressed, the "Pool/Spa" button will display with two choices:

1. Pool - With an initial timer set for 48 hours at 85° F.
2. Schedules - Without an active schedule, the heat pump mode is initially set to "OFF".

Pool Only, Pentair VS

**POOL ONLY
PENTAIR VS** **SELECT**

This preset configures the heat pump as follows:

- A Pentair (or Sta-Rite) variable speed circulation pump is configured.
- A pool schedule is configured (Everyday from 8:00 am to 6:00 pm)

When pressed, the "Pool/Spa" button will display with two choices.

1. Pool - With an initial timer set for 48 hours at 85° F.
2. Schedules

Pool Only, Hayward VSS

**POOL ONLY
HAYWARD VS SELECT**

This preset configures the heat pump as follows:

- A Hayward variable speed circulation pump is configured.
- A pool schedule is configured (Everyday from 8:00 am to 6:00 pm)

When pressed, the "Pool/Spa" button will display with two choices.

1. Pool - With an initial timer set for 48 hours at 85° F.
2. Schedules

Pool Only, Jandy VS

**POOL ONLY
JANDY VS SELECT**

This preset configures the heat pump as follows:

- A Jandy variable speed circulation pump is configured.
- A pool schedule is configured (Everyday from 8:00 am to 6:00 pm)

When pressed, the "Pool/Spa" button will display with two choices.

1. Pool - With an initial timer set for 48 hours at 85° F.
2. Schedules

Spa Only, No Pump

**SPA ONLY
NO EQUIPMENT SELECT**

This preset configures the heat pump as follows:

- No circulation pump is configured.
- No schedules are configured.

When pressed, the "Pool/Spa" button will display with two choices:

1. Spa - With an initial timer of 2 hours at 104° F.
2. Schedules

Spa Only, Pentair VS

**SPA ONLY
PENTAIR VS SELECT**

This preset configures the heat pump as follows:

- A Pentair (or Sta-Rite) variable speed circulation pump is configured.
- A pool schedule is configured (Everyday from 8:00 am to 6:00 pm)

When pressed, the "Pool/Spa" button will display with two choices.

1. Spa - With an initial timer of 2 hours at 104° F.
2. Schedules

Spa Only, Hayward VS

SPA ONLY
HAYWARD VS SELECT

This preset configures the heat pump as follows:

- A Hayward variable speed circulation pump is configured.
- A pool schedule is configured (Everyday from 8:00 am to 6:00 pm)

When pressed, the "Pool/Spa" button will display with two choices.

1. Spa - With an initial timer of 2 hours at 104° F.
2. Schedules

Spa Only, Jandy VS

SPA ONLY
JANDY VS SELECT

This preset configures the heat pump as follows:

- A Jandy variable speed circulation pump is configured.
- A pool schedule is configured (Everyday from 8:00 am to 6:00 pm)

When pressed, the "Pool/Spa" button will display with two choices.

1. Spa - With an initial timer of 2 hours at 104° F.
2. Schedules

**USE PRESET FROM USB
SELECT**

A file, previously saved onto a USB thumb drive, can be used to configure the heat pump. See "*Saving Installer Settings to USB*" on page 103.

PLEASE NOTE:

This file will take advantage of any custom configurations entered by the installer on prior installations. The file will contain the equipment, group, and schedule settings. Other settings such as multi-unit installations, external control mode, etc. will still need to be configured.

⚠ DANGER

Failure to heed the following will result in injury or death.

- Deactivate power while routing wiring to control board.
- RISK OF ELECTRICAL SHOCK FROM ENERGY STORED IN CAPACITORS - MODELS EQUIPPED WITH VARIABLE FREQUENCY COMPRESSOR DRIVES STORE ELECTRICITY EVEN AFTER THE POWER HAS BEEN DEACTIVATED AT THE POWER BREAKER. **Wait for 2 minutes after the shut down of equipment before servicing.**
- Follow all National Electric Codes (NEC) and/or State and Local guidelines.

1. Turn off power at heat pump's power disconnect.
2. **Wait two minutes for capacitors to discharge before proceeding.**
3. Remove heat pump electrical access panel.
4. Insert thumb drive into the heat pump's USB thumb drive port on the control board.
5. Activate power to heat pump. Do not touch thumb drive or electrical components inside heat pump. Risk of electrical shock can result in injury or death.
6. When installation wizard appears, select start.
7. Navigate to and select "USE SETUP FROM USB".
8. After heat pump has successfully loaded file and restarted, deactivate heat pump at power breaker.
9. **Wait two minutes for capacitors to discharge before proceeding.**
10. Remove thumb drive.
11. Reinstall heat pump's access panel.

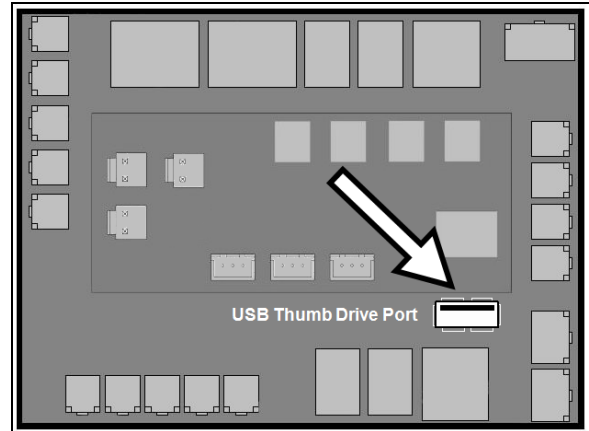

Figure 10 - USB Thumb Drive Port

1.8.I Configuring Groups

A group is used to control multiple devices (equipment) connected to the heat pump, either by manually activating the group through a shortcut, or scheduling the group to activate at a specified time.

EXAMPLES IN THIS SECTION:

I.1 Create a Group	66
I.2 Edit a Group	67
I.3 Delete a Group	68













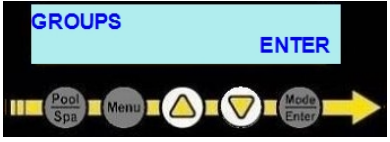

I.1 Create a Group

EXAMPLES OF GROUPS THAT CAN BE CREATED:

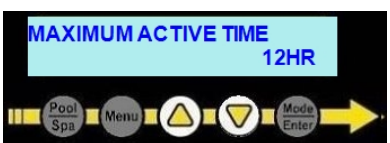
- A Custom Filtration Group -
 - This group could be used if the user didn't want to regulate the temperature of the water the entire time the circulation pump is activated. A custom group can be created that separates the amount of filtration time from the amount of time allowed for the heat pump to heat or cool the water.

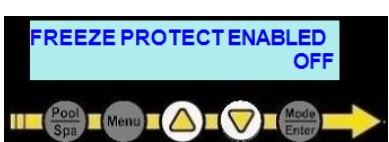
The example below shows a "FILTRATION" group being created manually.
A circulation pump will be added to the group.

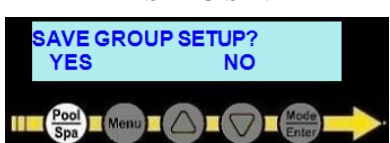
Enter "Groups" menus, then proceed

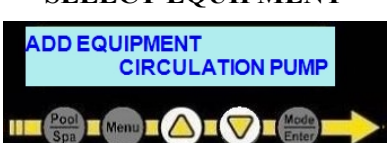
<p>IF UNIT IS ASLEEP, SWIPE TO WAKE UP</p> 	<p>A PRESS "MENU" BUTTON</p> 	<p>B USE ARROWS TO "GROUPS"</p> 
<p>C PRESS "ENTER"</p> 	<p>1 USE ARROWS TO "NEW GROUP SETUP"</p> 	<p>2 ENTER TO CREATE</p> 
<p>3 USE ARROWS TO NAME "FILTRATION"</p> 	<p>4 ENTER TO SAVE</p> 	<p>5 USE ARROWS TO SET MAXIMUM ACTIVE TIME</p> 
<p>6 ENTER TO SAVE</p> 	<p>7 USE ARROWS TO SET FREEZE PROTECT OPTION</p> 	<p>8 ENTER TO SAVE</p> 
<p>9 PRESS BUTTON UNDER "YES" TO SAVE</p> 	<p>10 PRESS "ENTER" TO ADD EQUIPMENT</p> 	<p>11 USE ARROWS TO SELECT EQUIPMENT</p> 

12 ENTER TO SAVE

13 USE ARROWS TO SET RPM

14 ENTER TO SAVE

MENU TO EXIT, PRESS & HOLD TO STATUS

The group is now ready to be activated using a shortcut or scheduled to activate at a certain time.

- See "Using a Group Shortcut" on page 79.
- See "Create a Schedule" on page 69.

I.2 Edit a Group

The example below shows a "FILTRATION" group being edited. An existing variable speed circulation pump will be deleted and an attached single speed circulation pump (named "POOL PUMP") will be added. The device will be set to be "ON" when the group is active.

Enter "Groups" menus, then proceed

IF UNIT IS ASLEEP, SWIPE TO WAKE UP

A PRESS "MENU" BUTTON

B USE ARROWS TO "GROUPS"

C PRESS "ENTER"







1 USE ARROWS TO "FILTRATION GROUP"

2 ENTER TO EDIT

3 USE ARROWS TO "REMOVE EQUIPMENT"

4 ENTER TO SELECT

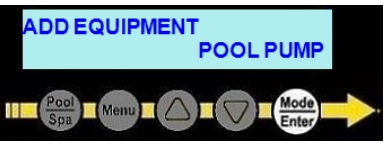
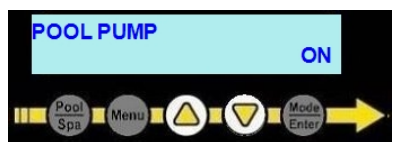







5 USE ARROWS TO DEVICE TO REMOVE

6 ENTER TO SELECT 	7 PRESS BUTTON UNDER "YES" TO CONFIRM 	8 USE ARROWS TO "ADD EQUIPMENT" 
9 ENTER TO SELECT 	10 USE ARROWS TO DEVICE TO ADD 	11 ENTER TO SELECT 
12 USE ARROWS TO SELECT DEVICE STATE 	13 ENTER TO SAVE 	MENU TO EXIT, PRESS & HOLD TO STATUS 

I.3 Delete a Group

The example below shows a "FILTRATION" group being deleted. Any schedules associated with that group will also be deleted.

Enter "Groups" menus, then proceed

IF UNIT IS ASLEEP, SWIPE TO WAKE UP 	A PRESS "MENU" BUTTON 	B USE ARROWS TO "GROUPS" 
C PRESS "ENTER" 	1 USE ARROWS TO "DELETE GROUP" 	2 ENTER TO SELECT 
3 USE ARROWS TO GROUP TO BE DELETED 	4 ENTER TO SELECT 	5 PRESS BUTTON UNDER "YES" TO CONFIRM 

MENU TO EXIT, PRESS & HOLD TO STATUS



1.8.J Configuring Schedules

A schedule can be used to activate a group of devices at a specified time.

- See "Configuring Groups" on page 65.

EXAMPLES IN THIS SECTION:

J.1 Create a Schedule	69
J.2 Edit a Schedule	71
J.3 Delete a Schedule	72

J.1 Create a Schedule

A maximum of four (4) schedule programs can be configured for each group.

The example below shows a "FILTRATION" group being scheduled.

Enter "Schedules" menus, then proceed

<p>IF UNIT IS ASLEEP, SWIPE TO WAKE UP</p>	<p>A PRESS MENU BUTTON</p>	<p>B USE ARROWS TO "SCHEDULES"</p>
<p>C PRESS "ENTER"</p>	<p>1 ARROWS TO GROUP TO SCHEDULE</p>	<p>2 ENTER TO EDIT</p>
<p>3 USE ARROWS TO THE PROGRAM TO SCHEDULE (1-4)</p>	<p>4 ENTER TO EDIT</p>	<p>5 USE ARROWS TO EDIT DAYS</p>

6 ENTER TO SAVE

PROGRAM 1 DAYS
S----S

Pool Spa Menu Mode/Enter

7 USE ARROWS TO "START" TIME

PROGRAM 1 START
08:00AM

Pool Spa Menu Mode/Enter

8 ENTER TO EDIT

PROGRAM 1 START
08:00AM

Pool Spa Menu Mode/Enter

9 USE ARROWS TO CHANGE

PROGRAM 1 START
09:00AM

Pool Spa Menu Mode/Enter

10 ENTER TO SAVE

PROGRAM 1 START
09:00AM

Pool Spa Menu Mode/Enter

11 USE ARROWS TO "END" TIME

PROGRAM 1 END
09:00PM

Pool Spa Menu Mode/Enter

12 ENTER TO EDIT

PROGRAM 1 END
09:00PM

Pool Spa Menu Mode/Enter

13 USE ARROWS TO CHANGE

PROGRAM 1 END
10:00PM

Pool Spa Menu Mode/Enter

14 ENTER TO SAVE

PROGRAM 1 END
10:00PM

Pool Spa Menu Mode/Enter

MENU TO EXIT, PRESS & HOLD TO STATUS

WATER TEMP ##°F
HEAT SETPOINT ##°F

Pool Spa Menu Mode/Enter

J.2 Edit a Schedule

The example below shows a pool group schedule being edited:

- From 8:00AM-5:00PM SMTWTFS (everyday)
- To 9:00AM-6:00PM -MTWTF- (Monday through Friday)

⚠ WARNING

Failure to heed the following may result in injury or death.













- When editing schedules containing the circulation pump, allow time for proper filtration.
- Follow all State and Local guidelines in regards to satisfying code-specified whole system turnover rates.

PLEASE NOTE:

This is not a recommended filtration schedule.

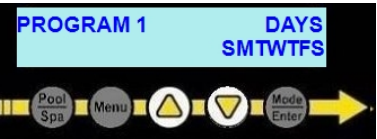
- What is shown is just an example of how to edit a schedule.
- The default schedule was initially created using one of the presets in the installer wizard.

Enter "Schedules" menus, then proceed

<p>IF UNIT IS ASLEEP, SWIPE TO WAKE UP</p> 	<p>A PRESS MENU BUTTON</p> 	<p>B USE ARROWS TO "SCHEDULES"</p> 
<p>C PRESS "ENTER"</p> 	<p>1 USE ARROWS TO "POOL GROUP"</p> 	<p>2 PRESS ENTER TO EDIT</p> 
<p>3 USE ARROWS TO SCHEDULE TO EDIT</p> 	<p>4 ENTER TO EDIT</p> 	<p>5 USE ARROWS TO "PROGRAM 1 DAYS"</p> 
<p>6 ENTER TO EDIT</p> 	<p>7 USE ARROWS TO CHANGE</p> 	<p>8 ENTER TO SAVE</p> 

<p>9 USE ARROWS TO "PROGRAM1 START"</p>	<p>10 ENTER TO EDIT</p>	<p>11 USE ARROWS TO CHANGE</p>
<p>12 ENTER TO SAVE</p>	<p>13 USE ARROWS TO "PROGRAM1 END"</p>	<p>14 ENTER TO EDIT</p>
<p>15 USE ARROWS TO CHANGE</p>	<p>16 ENTER TO SAVE</p>	<p>MENU TO EXIT, PRESS & HOLD TO STATUS</p>







J.3 Delete a Schedule

Select the group and then the program to edit. Use the clear option to remove the program's schedule.

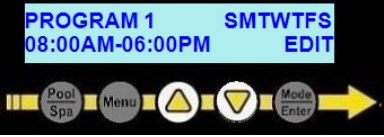
In the following example, the group "FILTRATION" has a schedule in "PROGRAM 1" that will be cleared (deleted).

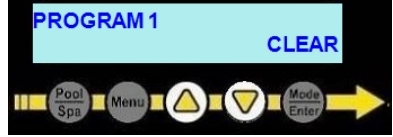
Enter "Schedules" menus, then proceed

<p>IF UNIT IS ASLEEP, SWIPE TO WAKE UP</p>	<p>A PRESS MENU BUTTON</p>	<p>B USE ARROWS TO "SCHEDULES"</p>
<p>C PRESS "ENTER"</p>	<p>1 ARROWS TO SCHEDULED GROUP</p>	<p>2 ENTER TO EDIT</p>

<p>3 USE ARROWS TO PROGRAM TO EDIT</p> 	<p>4 ENTER TO EDIT</p> 	<p>5 USE ARROWS TO "CLEAR"</p> 
<p>6 ENTER TO SELECT</p> 	<p>7 SELECT "YES" TO CLEAR PROGRAM</p> 	<p>MENU TO EXIT, PRESS & HOLD TO STATUS</p> 

1.8.K Schedule and Program Modes









Schedules can be deactivated temporarily as needed. Either globally through a schedule mode, or individually by setting a group's program mode.

SCHEDULE MODE	Description	
"AUTO"	The default mode. This allows schedules to run normally.	See " <i>Set Schedule Mode to "AUTO"</i> " on the facing page.
"AWAY"	This mode is generally used when the user is away on vacation and doesn't want to maintain a water temperature. The heat pump will be deactivated while the rest of the schedules (including filtration) are allowed to continue.	See " <i>Set Schedule Mode to "AWAY"</i> " on the facing page.
"OFF"	This mode turns off all schedules. The schedules resume when the schedule mode is set to "AUTO" again. Please note - this will also halt any connected circulation pump activity. This option is not meant for long term usage.	See " <i>Set Schedule Mode to "OFF"</i> " on page 75.

PROGRAM MODE	Description	
"ON"	A group's scheduled programs are set to operate normally.	See " <i>Set Group Programs to "ON"</i> " on page 75.
"PAUSED"	A group's scheduled programs will be paused. The programs will automatically resume the next scheduled day. No other group's activities will be effected.	See " <i>Set Group Programs to "PAUSED"</i> " on page 76.
"OFF"	This mode turns off all schedule programs for the group indefinitely. Programs resume when the program mode is set to "ON" again.	See " <i>Set Group Programs to "OFF"</i> " on page 77.









Set Schedule Mode to "AUTO"

Enter "Shortcuts" menus, then proceed

<p>IF UNIT IS ASLEEP, SWIPE TO WAKE UP</p> 	<p>A PRESS MENU BUTTON</p> 	<p>B USE ARROWS TO "SHORTCUTS"</p> 
<p>C PRESS "ENTER"</p> 	<p>1 ARROWS TO "SCHEDULE MODE"</p> 	<p>2 ENTER TO EDIT</p> 
<p>3 ARROWS TO "AUTO"</p> 	<p>4 ENTER TO SAVE</p> 	<p>MENU TO EXIT, PRESS & HOLD TO STATUS</p> 

Set Schedule Mode to "AWAY"

Enter "Shortcuts" menus, then proceed

<p>IF UNIT IS ASLEEP, SWIPE TO WAKE UP</p> 	<p>A PRESS MENU BUTTON</p> 	<p>B USE ARROWS TO "SHORTCUTS"</p> 
<p>C PRESS "ENTER"</p> 	<p>1 ARROWS TO "SCHEDULE MODE"</p> 	<p>2 ENTER TO EDIT</p> 
<p>3 ARROWS TO "AWAY"</p> 	<p>4 ENTER TO SAVE</p> 	<p>5 ARROWS AND ENTER TO SET END DATE</p> 

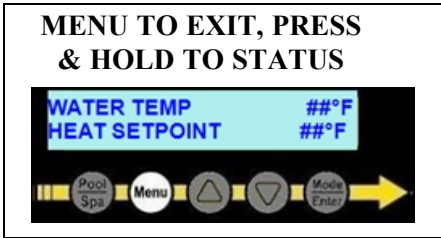

Set Schedule Mode to "OFF"

Enter "Shortcuts" menus, then proceed

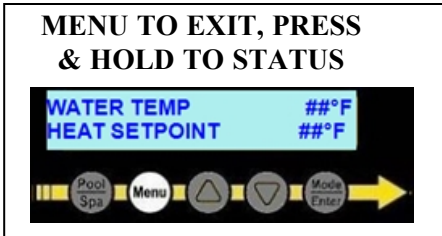
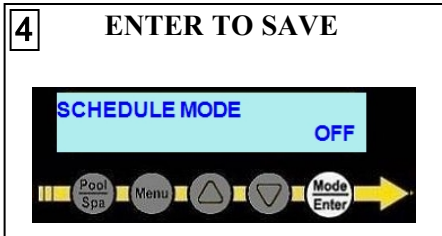
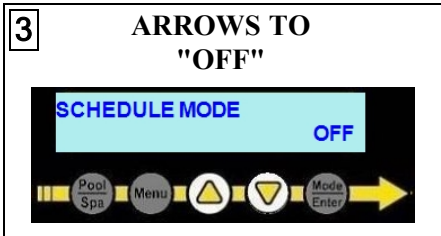
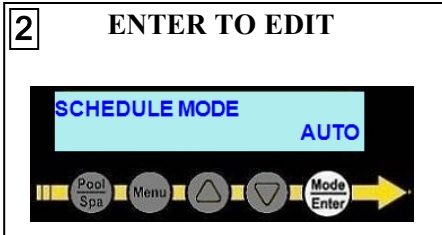
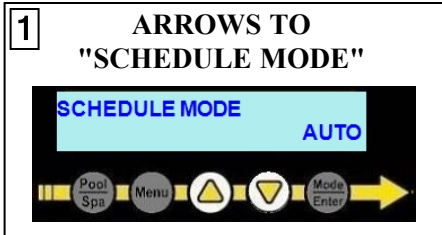
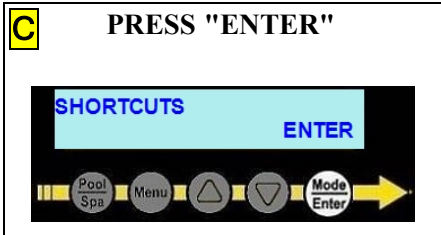
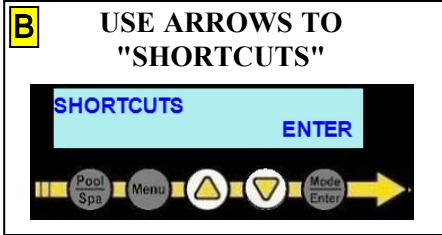
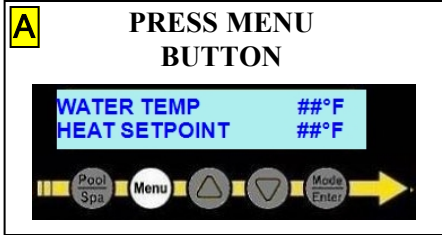
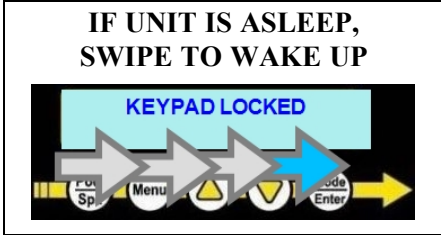





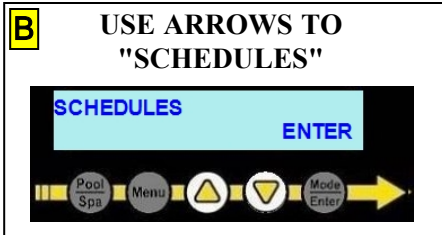
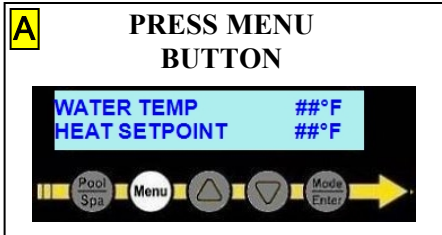
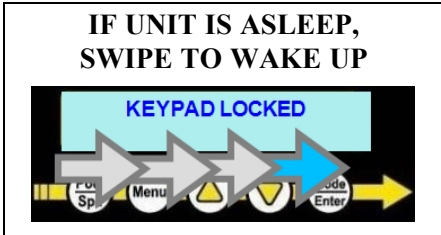

Set Group Programs to "ON"

In the following example, the "Pool" group's set of scheduled programs will be set from "PAUSED" back to "ON".

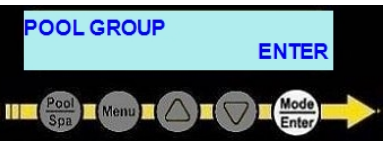
Enter "Schedules" menus, then proceed

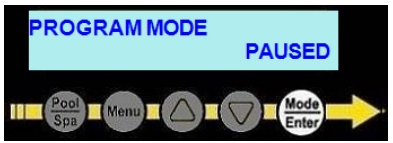
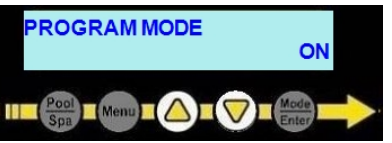







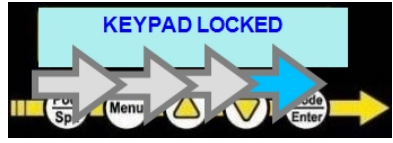

<p>C PRESS "ENTER"</p> 	<p>1 ARROWS TO "POOL GROUP"</p> 	<p>2 ENTER TO EDIT</p> 
<p>3 ARROWS TO "PROGRAM MODE"</p> 	<p>4 ENTER TO EDIT</p> 	<p>5 ARROWS TO "ON"</p> 
<p>6 ENTER TO SAVE</p> 	<p>MENU TO EXIT, PRESS & HOLD TO STATUS</p> 	

Set Group Programs to "PAUSED"

In the following example, the "Pool" group's set of scheduled programs will be paused. This will continue until the programs are set back to "ON".

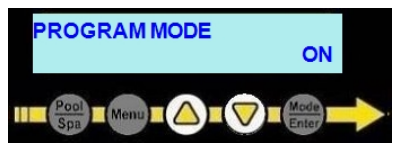
Enter "Schedules" menus, then proceed

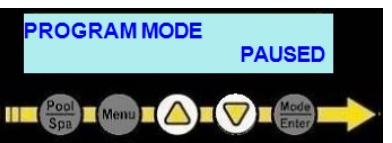
<p>IF UNIT IS ASLEEP, SWIPE TO WAKE UP</p> 	<p>A PRESS MENU BUTTON</p> 	<p>B USE ARROWS TO "SCHEDULES"</p> 
<p>C PRESS "ENTER"</p> 	<p>1 ARROWS TO "POOL GROUP"</p> 	<p>2 ENTER TO EDIT</p> 
<p>3 ARROWS TO "PROGRAM MODE"</p> 	<p>4 ENTER TO EDIT</p> 	<p>5 ARROWS TO "PAUSED"</p> 

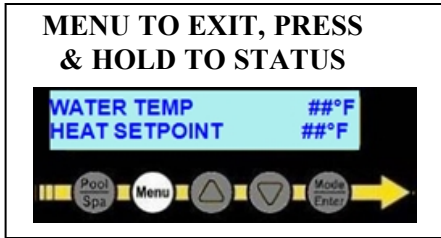
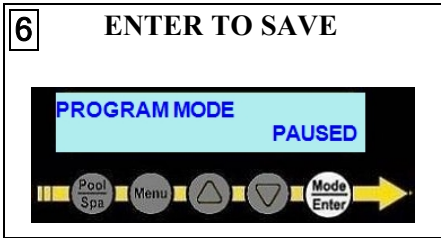

Set Group Programs to "OFF"

In the following example, the "Pool" group's set of scheduled programs will be set from "ON" to "OFF".
The schedules will not resume until the programs are set back to "ON".

Enter "Schedules" menus, then proceed

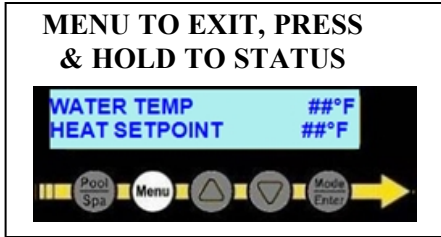
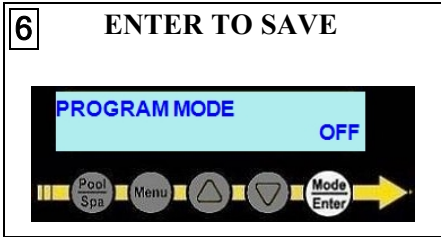
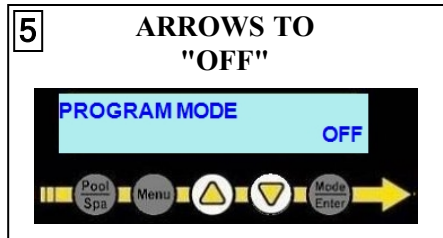
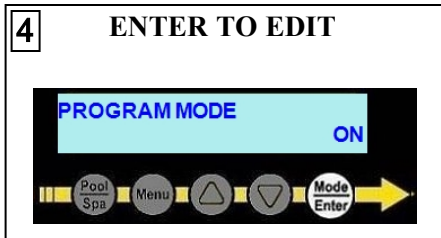
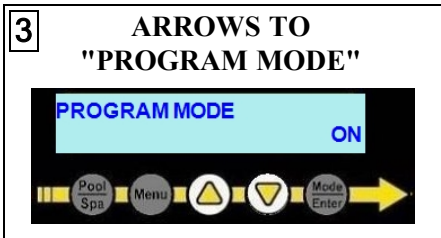
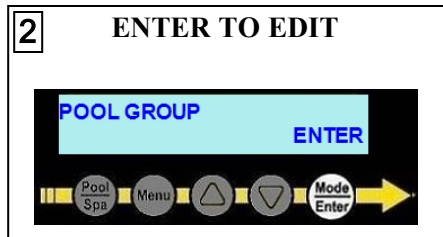
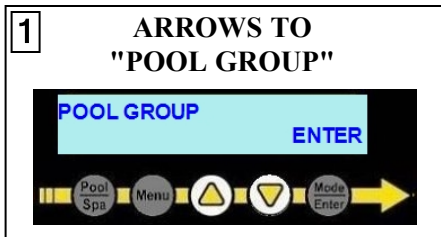
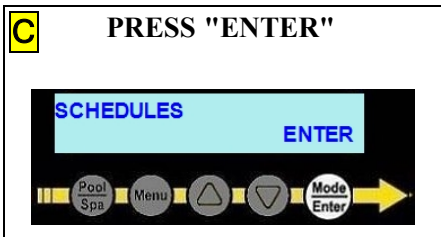
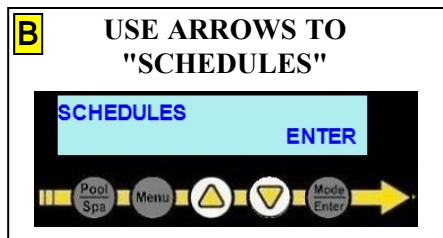
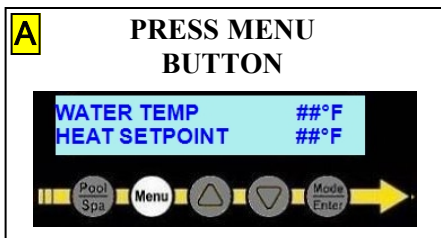
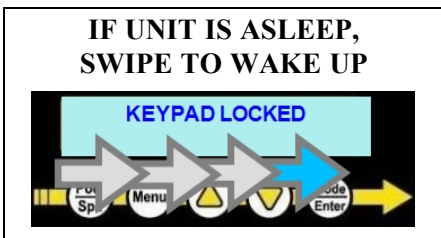

1.8.L Using Shortcuts

The shortcuts menu provides quick access to model specific options and features. The following outlines some of these options.

Group Access

As a group is created, a shortcut automatically appears in the shortcuts menu. The user can activate the group by shortcut and will be asked how long to operate that group.

- Multiple group shortcuts can operate at the same time. The time remaining for each group to operate will appear on the status screen.
- After the group shortcut timer expires, the heat pump group will resume its normally scheduled activity.
- To cancel the group shortcut's operation before its timer expires, go to the shortcut menu, select it, and choose "STOP".
- See "*Using a Group Shortcut*" on the next page.
- See "*Stopping a Group Shortcut*" on the next page.

PLEASE NOTE:

The Spa and Pool groups (if applicable) will not appear in the shortcuts menu. Use the schedules or the Pool / Spa button to activate those groups.

Schedule Mode

There are three modes that can be set when running schedules.

- "AUTO" - The default mode. This allows schedules to run normally.
- "AWAY" - This mode is generally used when the user is away on vacation and doesn't want to maintain a water temperature. The heat pump will be deactivated while the rest of the schedules (including filtration) are allowed to continue.
- "OFF" - This mode turns off all schedules. The schedules resume when the schedule mode is set to "AUTO" again.
- (See "*Schedule and Program Modes*" on page 73 for more information.)

Service Mode

This mode will deactivate the heat pump as well as all equipment connected to the heat pump.

- (See "*Service Mode*" on page 105 for more information.)

Solar Menus

Additional menus are provided for heat pumps that control solar equipment.

- Solar Boost (Eco Mode Only) - See "*Solar Boost (ECO Mode Only)*" on page 43.
- Solar Setpoint - See "*Set a desired temperature (setpoint) for the solar system to activate (Select Units)*" on page 56.
- Solar Control Mode - See "*Solar Control Mode*" on page 40.
- Roof Temperature - See "*Viewing Solar Roof Temperature*" on page 48.

Turbo Boost (Variable Speed Heat Pumps Only)









Upon demand, the heat pump's compressor can be set to maximum speed to heat or cool the water quickly. This is regardless of any previously set efficiency mode settings.

- The system will heat or cool the water with the compressor speed set to maximum. This will continue until the set temperature is reached. Then the configured efficiency mode (either 24-hour or scheduled) will resume.
- (See "Configure Variable Speed Compressors (Select Units)" on page 83 for more information.)

Using a Group Shortcut

In this example, a user activates a group that was previously created called "FILTRATION".

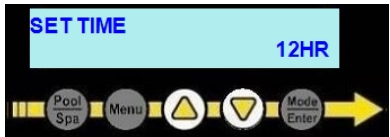
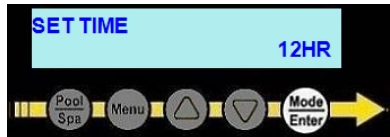
Enter "Shortcuts" menus, then proceed

IF UNIT IS ASLEEP, SWIPE TO WAKE UP 	A PRESS MENU BUTTON 	B USE ARROWS TO "SHORTCUTS" 
C PRESS "ENTER" 	1 ARROWS TO SHORTCUT TO USE 	2 ENTER TO SELECT SHORTCUT 
3 ENTER TO START 	4 ARROWS TO MAXIMUM TIME TO OPERATE 	5 ENTER TO ACTIVATE 
MENU TO EXIT, PRESS & HOLD TO STATUS 	<p>On the status screen the group will show as active. It will then display the time remaining before the group expires.</p>	

Stopping a Group Shortcut

In this example a group called "FILTRATION" is deactivated before it's time expires.

Enter "Shortcuts" menus, then proceed

IF UNIT IS ASLEEP, SWIPE TO WAKE UP

The diagram shows a screen with the text "KEYPAD LOCKED" in a blue box. Below the screen are five buttons: "Pool Spa", "Menu", a left arrow, a right arrow, and "Mode Enter". A grey arrow points from the "Menu" button to the right arrow, and a blue arrow points from the right arrow to the "Mode Enter" button.

A PRESS MENU BUTTON

The diagram shows a screen with "WATER TEMP ##°F" and "HEAT SETPOINT ##°F" in a blue box. Below the screen are five buttons: "Pool Spa", "Menu", a left arrow, a right arrow, and "Mode Enter". The "Menu" button is highlighted with a yellow background.

B USE ARROWS TO "SHORTCUTS"

The diagram shows a screen with "SHORTCUTS" and "ENTER" in a blue box. Below the screen are five buttons: "Pool Spa", "Menu", a left arrow, a right arrow, and "Mode Enter". The left arrow button is highlighted with a yellow background.

C PRESS "ENTER"

The diagram shows a screen with "SHORTCUTS" and "ENTER" in a blue box. Below the screen are five buttons: "Pool Spa", "Menu", a left arrow, a right arrow, and "Mode Enter". The "Mode Enter" button is highlighted with a yellow background.

1 ARROWS TO SHORTCUT TO STOP

The diagram shows a screen with "FILTRATION GROUP ACTIVE" and "ENTER" in a blue box. Below the screen are five buttons: "Pool Spa", "Menu", a left arrow, a right arrow, and "Mode Enter". The right arrow button is highlighted with a yellow background.

2 ENTER TO SELECT

The diagram shows a screen with "FILTRATION GROUP ACTIVE" and "ENTER" in a blue box. Below the screen are five buttons: "Pool Spa", "Menu", a left arrow, a right arrow, and "Mode Enter". The "Mode Enter" button is highlighted with a yellow background.

3 ENTER TO STOP

The diagram shows a screen with "FILTRATION GROUP ACTIVE" and "STOP" in a blue box. Below the screen are five buttons: "Pool Spa", "Menu", a left arrow, a right arrow, and "Mode Enter". The "Mode Enter" button is highlighted with a yellow background.

MENU TO EXIT, PRESS & HOLD TO STATUS

The diagram shows a screen with "WATER TEMP ##°F" and "HEAT SETPOINT ##°F" in a blue box. Below the screen are five buttons: "Pool Spa", "Menu", a left arrow, a right arrow, and "Mode Enter". The "Menu" button is highlighted with a yellow background.

IN THIS SECTION:

2.1 Adjusting Water Flow Using ΔT (Delta-T)	81
2.2 Adjusting Water Pressure Switch (Select Units)	82
2.3 Configure Variable Speed Compressors (Select Units)	83
2.4 Clearances	87
2.5 Cleaning Equipment After Installation	87
2.6 Dimensions	89
2.7 Equipment Parameters	90
2.8 Factory Reset	91
2.9 Freeze Protection	92
2.10 FS2 Turbo Boost Enable (Select Units)	94
2.11 Identifying Model Specifications	95
2.12 Menu Trees	97
2.13 Three-Phase Adjustment	99
2.14 Viewing System Information	99
2.15 Weights	100
2.16 RPM Adjustments	101
2.17 Saving Installer Settings to USB	103
2.18 Initial Heating Recommendations	104
2.19 Initial Cooling Recommendations	104
2.20 Service Mode	105
2.21 Winterizing	106
2.22 Available Accessories	107

2.1 Adjusting Water Flow Using ΔT (Delta-T)

The Delta-T is the temperature difference between the water temperatures entering and leaving the heat pump.

The equipment can be fine-tuned for maximum performance by balancing water flow rates to maintain an ideal ΔT .

The adjustment procedure must be completed with the unit in heating mode and solar system set to OFF. See "Set Solar Control to SOLAR OFF" on page 41.

PLEASE NOTE -

- The installation of temperature ports is required for all commercial applications.
- The installation of temperature ports is strongly recommended for residential installations.
 - See "Temperature Port Kit (# STK0096)" on page 109.

1. Adjust the thermostat to its lowest setting with the unit in heating mode.
2. Deactivate the water filtration pump.
3. Confirm that the filters leading to the heat pump are clean.
4. Adjust the valves controlling water headed towards the heat pump to the half-open position.
5. Adjust the valves controlling water leading away from the heat pump to a fully open position.
6. Activate the pool water filtration pump.

**Temperature Port
(Shown with Probe)**



7. Slowly raise the thermostat temperature until the heat pump activates.
 - After a four-minute delay, the heat pump's compressor will start.
8. With the heat pump running, confirm the filtration pump is operating properly with adequate flow and no short cycling.
9. Wait for water temperatures to stabilize (approximately 5 minutes).
10. Adjust valves in the following order using the temperature chart provided.
 - a. Adjust the valve that controls water exiting the heat pump until the correct temperature differential is achieved. Match the temperature measured with a temperature probe to the chart.
 - b. Wait for water temperatures to stabilize. Then check the temperature again. Re-adjust the valve as needed.
11. Mark valves at these positions for future reference.

HEAT EXCHANGER TYPE	MODEL	TEMPERATURE
Titanium ThermoLink®	SQ140	3° to 7° F (1.7° C to 3.9° C)
Titanium ThermoLink®	SQ160	4° to 8° F (2.2° C to 4.4° C)
Titanium ThermoLink®	SQ200	3° to 8° F (1.7° C to 4.4° C)
Titanium ThermoLink®	TC1000	2° to 5° F (1.1° C to 2.8° C)
Titanium ThermoLink®	TC1500	3° to 7° F (1.7° C to 3.9° C)

Table 2 - Temperature Chart

PLEASE NOTE -

- Temperature differences are based on pool water temperatures of 69° to 75° F. (20.5° to 23.8° C)
- For water temperatures outside this range, contact AquaCal®. See "**Contacting AquaCal AutoPilot, Inc.**".

2.2 Adjusting Water Pressure Switch (Select Units)

Adjust the water pressure switch when heat pump attempts to operate without water flow.

Before attempting any adjustments confirm the following :

- The filter is clean.
- Filter pump is operating.
- The valves are set to direct the appropriate amount of water through the heat pump. See "*Water Flow Rates*" on page 12.
- "**NO POOL/SPA WATER FLOW**" is displayed (or displays intermittently).

⚠ DANGER

Failure to heed the following will result in injury or death.

- Deactivate power while routing wiring to control board.
- RISK OF ELECTRICAL SHOCK FROM ENERGY STORED IN CAPACITORS - MODELS EQUIPPED WITH VARIABLE FREQUENCY COMPRESSOR DRIVES STORE ELECTRICITY EVEN AFTER THE POWER HAS BEEN DEACTIVATED AT THE POWER BREAKER. ***Wait for 2 minutes after the shut down of equipment before servicing.***
- Follow all National Electric Codes (NEC) and/or State and Local guidelines.

⚠ WARNING

Failure to heed the following may result in injury or death.

- Water Pressure Switch adjustment procedure to be performed by experienced service personnel only; procedure must not be attempted by individuals lacking adequate electrical and mechanical experience.

NOTICE

Failure to heed the following may result in damage to equipment.

- If the heat pump continues to operate after a water pressure switch adjustment, deactivate equipment and perform additional troubleshooting.

1. Remove heat pump access panel.
2. Locate the water pressure switch. It will be outside and along the bottom edge of the electrical enclosure. The exact location varies by model.
3. Activate the filter pump.
4. Apply power to heat pump.
5. Slowly rotate the adjustment wheel on the switch. Keep turning the wheel until the heat pump indicates it is receiving water. The display will no longer indicate "**NO POOL/SPA WATER FLOW**".
6. Deactivate filter pump. If correctly adjusted, the heat pump will deactivate and the display will show "**NO POOL/SPA WATER FLOW**".
7. Re-install heat pump access panel.
8. If the heat pump continues to operate without water flow, the installation of a grid flow switch may be required.
 - This can become necessary if the heat pump is installed below the elevation of the body of water to be heated or cooled. The standing pressure from the water can cause the water pressure switch to activate when the circulation pump is off. Therefore a water flow switch must be used in place of a water pressure switch to determine if incoming water is being sent to the heat pump. See "*Grid Flow Switch (# 0040S)*" on page 108.
9. If the heat pump continues to operate without water flow, contact AquaCal®.

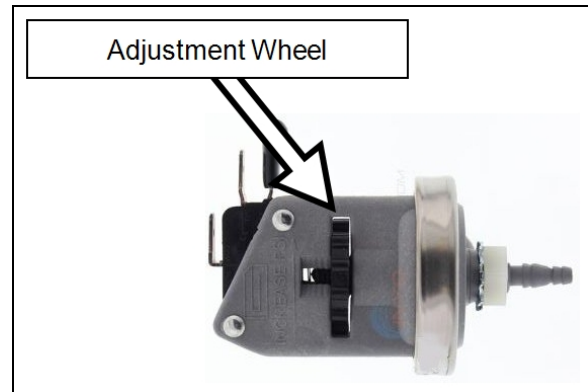

2.3 Configure Variable Speed Compressors (Select Units)

Selected heat pumps have variable speed compressors designed to more quickly and efficiently reach a temperature set point. The compressor's performance can be controlled using a turbo boost mode (in the shortcuts menus) or two different types of efficiency modes.

Turbo Boost

Upon demand, the heat pump's compressor can be set to maximum speed to heat or cool the water quickly. This is regardless of any previously set efficiency mode settings.

- The system will heat or cool the water with the compressor speed set to maximum. This will continue until the set temperature is reached. Then the configured efficiency mode (scheduled or 24-hour) will resume.
- See "Turbo Boost" below.

Efficiency Mode - 24 Hour

When using this mode, the compressor increases to a higher rate of speed until the temperature set point is reached.

- The compressor speed will then lower to maintain that temperature set point. This will continue as long as there is water flow.
- See "Set Efficiency Mode to 24 Hour" on the next page.







Efficiency Mode - Filtration Schedule

When using this mode, the compressor's speed is set to heat or cool the water within 60% of the circulation pump's filtration time period. This is the highest efficiency operational mode, providing the lowest cost of operation.

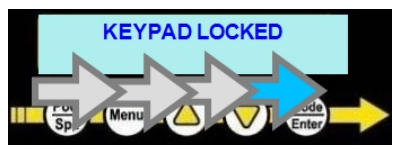
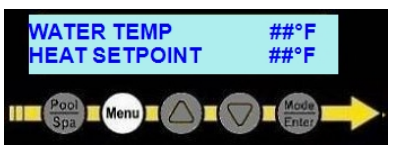
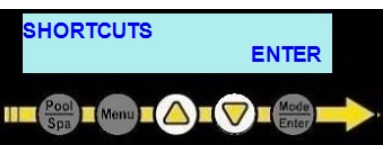
- Example - If the filtration period is set from 10:00 am to 8:00 pm, the system attempts to bring the water to set point by 4:00 pm at optimal performance.
- See "Set Efficiency Mode to Filtration Schedule" on the next page.

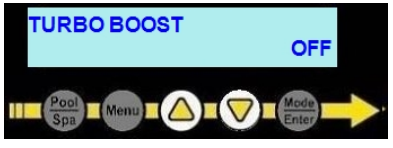
Turbo Boost

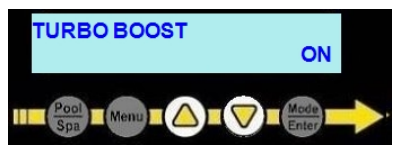
Enter "Shortcuts" menus, then proceed

<p>IF UNIT IS ASLEEP, SWIPE TO WAKE UP</p> 	<p>A PRESS MENU BUTTON</p> 	<p>B USE ARROWS TO "SHORTCUTS"</p> 
<p>C PRESS "ENTER"</p> 	<p>1 USE ARROWS TO MENU "TURBO BOOST"</p> 	<p>2 ENTER TO EDIT</p> 
<p>3 USE ARROWS TO CHANGE</p> 	<p>4 ENTER TO SAVE</p> 	<p>MENU TO EXIT, PRESS & HOLD TO STATUS</p> 

Set Efficiency Mode to 24 Hour

Enter "Advanced" menus, then proceed

IF UNIT IS ASLEEP, SWIPE TO WAKE UP



A PRESS MENU BUTTON



B USE ARROWS TO "SYSTEM"

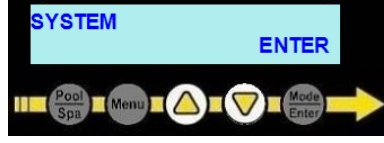

C PRESS "ENTER"



D USE ARROWS TO "ADVANCED"

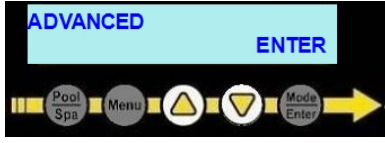

E PRESS "ENTER"



1 USE ARROWS TO MENU "EFFICIENCY MODE"



2 ENTER TO EDIT



3 USE ARROWS TO CHANGE TO "24HR"



4 ENTER TO SAVE



MENU TO EXIT, PRESS & HOLD TO STATUS



Set Efficiency Mode to Filtration Schedule

Enter "Advanced" menus, then proceed

IF UNIT IS ASLEEP, SWIPE TO WAKE UP



A PRESS MENU BUTTON



B USE ARROWS TO "SYSTEM"

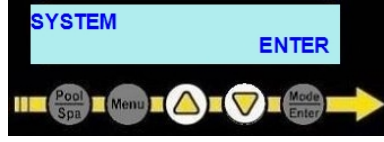

C PRESS "ENTER"



D USE ARROWS TO "ADVANCED"

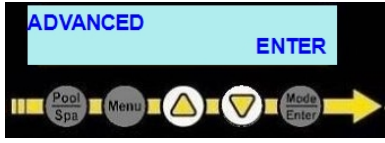

E PRESS "ENTER"



1 USE ARROWS TO MENU "EFFICIENCY MODE"

2 ENTER TO EDIT

3 USE ARROWS TO CHANGE TO "FILTRATION"

4 ENTER TO SAVE

MENU TO EXIT, PRESS & HOLD TO STATUS

2.4 Clearances

- Proper air circulation is required for the heat pump to operate efficiently. The following diagrams show the minimum clearances required for the proper operation of the heat pump.
- Avoid placing objects near or on top of the heat pump. This includes shrubbery and lawn furniture. These objects will reduce performance and efficiency and hinder maintenance access.

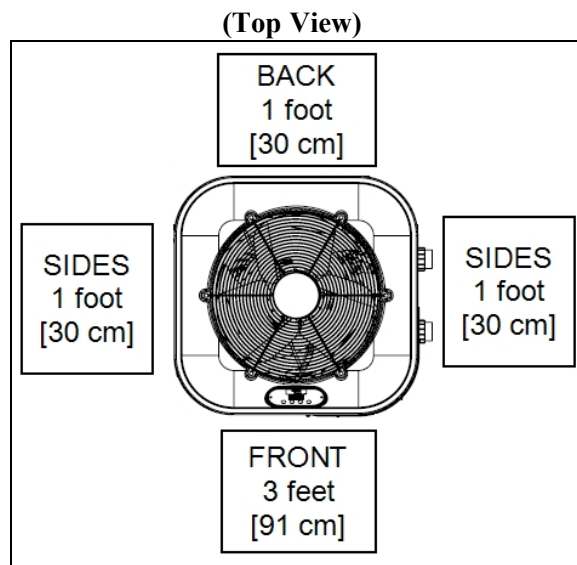
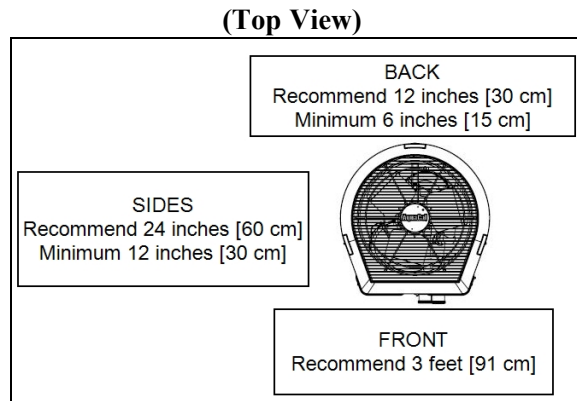
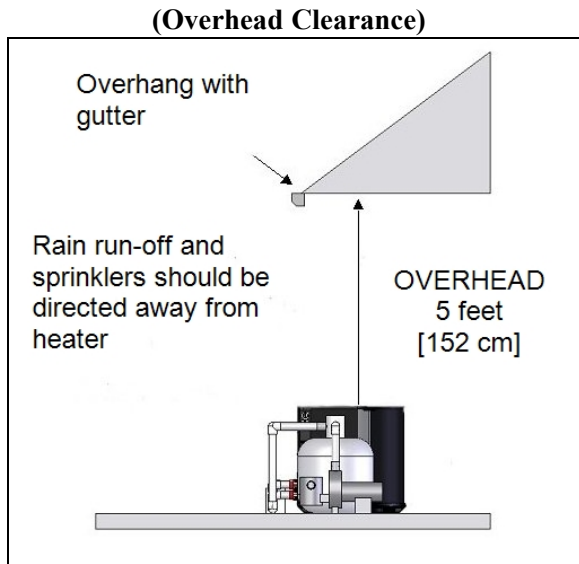

2.5 Cleaning Equipment After Installation

Installer - If you need to clean the equipment after installation, please use the following guidelines.

WARNING

Failure to heed the following may result in injury or death.

- Possible electric shock hazard - Deactivate power to all electrical devices on the pad when washing heat pump. Do not restore electrical power until equipment is completely dry.

NOTICE

Failure to heed the following may result in damage to equipment.

- Do not use a pressure cleaner to wash the heat pump. Damage to heat pump components may result. If using a hose-end spray nozzle adjust the spray pattern to low strength only.
- Do not spray water directly into the interior of the heat pump; damage to components may result.
- Do not use chemicals on the display panel.

Cleaning

1. Wash cabinet using a low-pressure water hose. A high-pressure water stream will cause damage to the aluminum fins of the heat pump. This damage is not covered under the product warranty.
2. While the heat pump is still wet, use an approved cleaning agent to clean the exterior of the heat pump. **Do not use chemicals on the display panel.**
3. Use a detergent-dampened cloth to wipe the heat pump's exterior cabinet.
4. Flush all exterior with fresh water using a low-pressure water hose.
5. Dry the cabinet using a soft cloth being careful not to damage fins.

APPROVED CLEANING AGENTS*
Fantastic®
Formula 409®
Cascade®
All Power Plain Detergent (3% Solution)

Table 3 - Cleaning Agents

- * The trademarks used in approved cleaning agents are the property of their owners and are not related to AquaCal®.

Polishing

1. Polish the heat pump's cabinet panels using an approved polishing agent and following the manufacturer's instructions. **Do not use chemicals on the display panel.**
2. Rinse the heat pump panels with fresh water, wipe, and buff panels using a dry soft cloth.
3. Allow heat pump interior and surrounding equipment to "air-dry" for several hours prior to restoring electrical power.

APPROVED POLISHING AGENTS*
Simoniz® Wax
Glo-Coat®
Armor All® Protectant

Table 4 - Polishing Agents

- * The trademarks used in approved polishing agents are the property of their owners and are not related to AquaCal®.

2.6 Dimensions

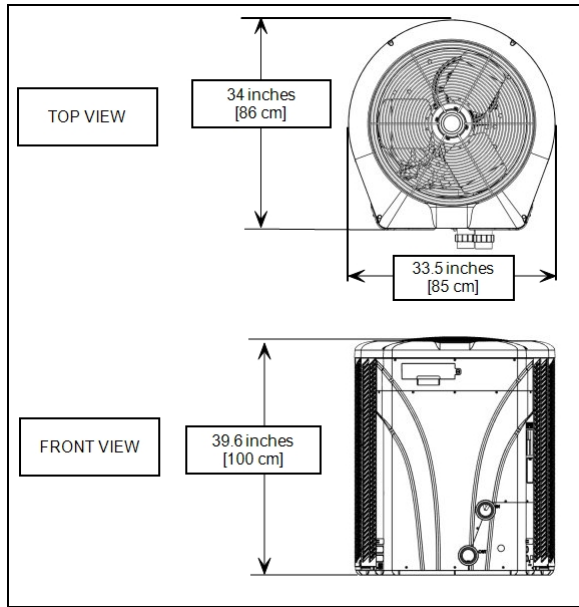

HeatWave SuperQuiet® SQ140R, SQ160R and SQ200R

TropiCool® TC1000C TC1500

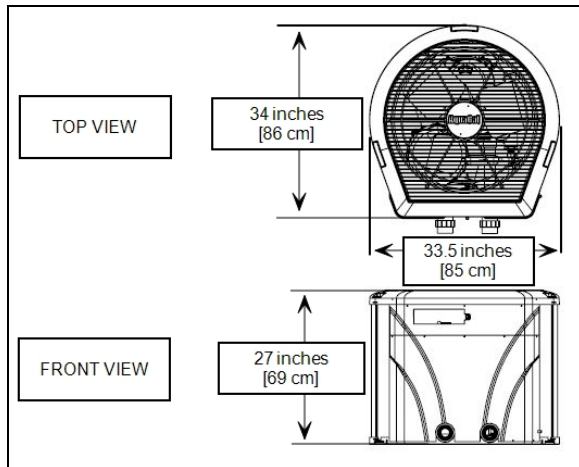
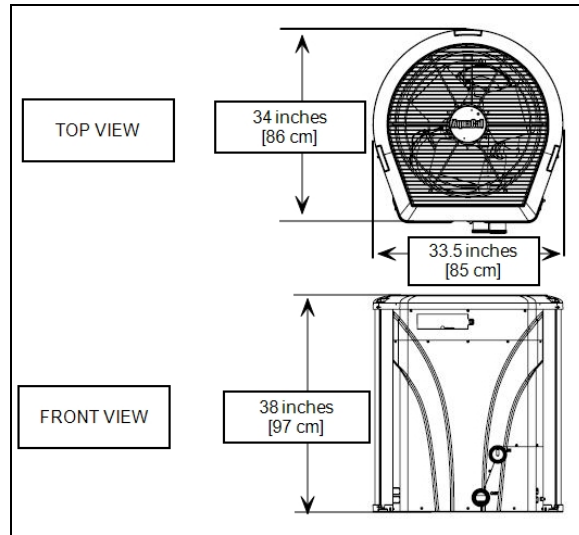

TropiCal® Inverter T035, T055, T075

TropiCool® TC500

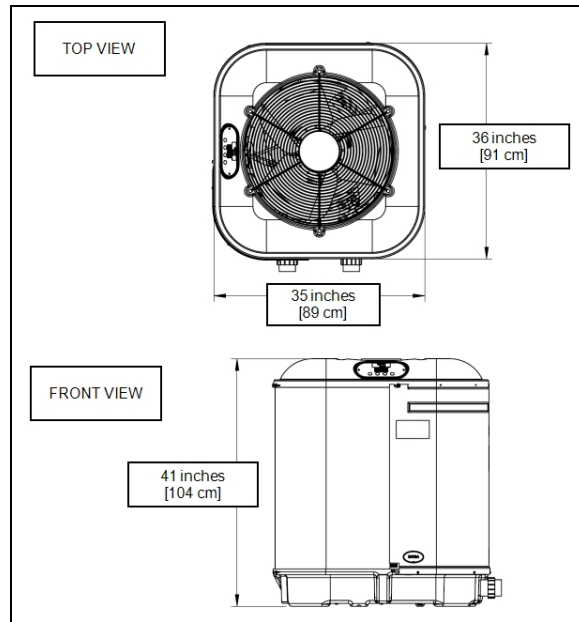

TropiCal® Inverter T170

2.7 Equipment Parameters

This section describes all the possible parameters for equipment that can be connected to the heat pump.

Pumps

Parameter	Description
Name	A set of labels is provided for easy identification of the circulation pump.
Pump Type	A choice between a variable speed or single speed circulation pump is provided.
Port	This is the connection port where a circulation pump is connected to the heat pump. <ul style="list-style-type: none"> The connection ports are normally "Port B" on the control board for a variable speed circulation pumps. And expansion board ports "A" (default), "C", and / or "D" for single speed or multi-speed circulation pumps.
Minimum Speed	The minimum allowed speed for the circulation pump to operate.
Maximum Speed	The maximum allowed speed for the circulation pump to operate.
Priming Time	The amount of time allowed to prime the variable speed circulation pump to remove air bubbles in the lines. Air bubbles would prevent the water from circulating properly in the system.
Priming Speed	The variable speed circulation pump's operating speed when priming the equipment.
Heat / Cool Speed	The speed a variable speed circulation pump must run when actively heating or cooling the water.

Chlorinator

Parameter	Description
Name	A set of labels are provided for easy identification of the chlorination system's connection port on the control board.
Chlorinator Type	Currently there is only one choice for this option. (CHLORSYNC).
Port	This is the logical ID of the device (default is "BROADCAST"). The device itself would be connected to the heat pump via a PoolSync device on port "D". See " <i>PoolSync® WiFi Controller (ECP0343)</i> " on page 109.

2.8 Factory Reset

A factory reset of all settings can be performed.

This will reset all settings to factory defaults.

PLEASE NOTE:









This action will wipe all previously set configurations such as external controller settings, optional device settings, groups, equipment, schedules, and site specific settings and return the heat pump to its default firmware settings from the factory.

NOTICE

Failure to heed the following may result in damage to equipment.

- Any site specific settings entered by the installer will be lost when performing this operation.

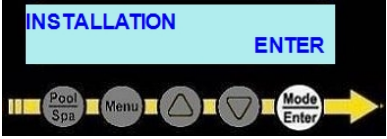
Enter "Installation" menus, then proceed

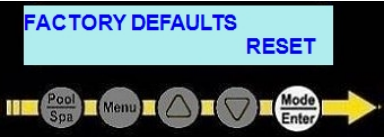
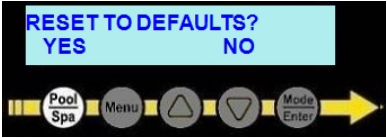
<p>IF UNIT IS ASLEEP, SWIPE TO WAKE UP</p> 	<p>A PRESS MENU BUTTON</p> 	<p>B USE ARROWS TO "SYSTEM"</p> 
<p>C PRESS "ENTER"</p> 	<p>D USE ARROWS TO "ADVANCED"</p> 	<p>E PRESS "ENTER"</p> 
<p>F USE ARROWS TO "INSTALLATION"</p> 	<p>G PRESS "ENTER"</p> 	<p>1 USE ARROWS TO MENU "FACTORY DEFAULTS"</p> 
<p>2 ENTER TO SELECT</p> 	<p>3 PRESS BUTTON UNDER "YES" TO CONFIRM</p> 	

The system will restart and operate as if no equipment is connected directly to the heat pump.

2.9 Freeze Protection

When freeze protection is active, water is circulated through designated group's plumbing circuits in 5 minute cycles. The water circulation lowers the chances of water freezing in those circuits.

- Freeze protection will automatically activate when the air temperature falls below 37° F (3° C).
- When the air temperature rises to 42° F (6° C), freeze protection will deactivate.
- These set temperatures and cycle times can be adjusted as needed in settings. See "*Adjusting Freeze Protection Options*" on the next page.

PLEASE NOTE:

- Freeze protection is meant to be temporary. If freezing temperatures will continue for an extended time frame, the pool equipment ***must*** be winterized.
- The heat pump will not attempt to heat water in freezing conditions.
- As a group cycles on and off, any devices contained within that group will also cycle on and off. If this behavior is undesirable, the device can either be removed from the group or manually deactivated.









Requirements for Freeze Protection

- A circulation pump must exist in the group to be protected.
- Water flow must be properly directed through the group's plumbing circuit via valve actuators.
- The group's freeze protection option must be set to on.

Adjusting Groups to Allow Freeze Protection

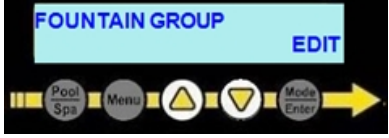
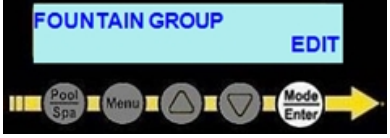
In the following example, a "FOUNTAIN" group is edited to enable freeze protection.

Enter "Groups" menus, then proceed

<p>IF UNIT IS ASLEEP, SWIPE TO WAKE UP</p> 	<p>A PRESS "MENU" BUTTON</p> 	<p>B USE ARROWS TO "GROUPS"</p> 
<p>C PRESS "ENTER"</p> 	<p>1 USE ARROWS TO GROUP TO EDIT</p> 	<p>2 PRESS "ENTER" TO EDIT</p> 
<p>3 ARROWS TO "FREEZE PROTECT ENABLED"</p> 	<p>4 PRESS "ENTER" TO EDIT</p> 	<p>5 USE ARROWS TO CHANGE TO "ON"</p> 

MENU TO EXIT, PRESS & HOLD TO STATUS



Adjusting Freeze Protection Options

NOTICE Failure to heed the following may result in damage to equipment.

- Use extreme care when setting and adjusting freeze protection options. Improper freeze protection settings can cause damage to equipment. This is not covered by heat pump warranty.

Available freeze protection options:

- "PROTECT ON SETPOINT" can be adjusted from 33° F to 39° F (.6° C to 4° C). The default is 37° F (3° C).
- "PROTECT OFF SETPOINT" can be adjusted from 40° F to 45° F (4° C to 7° C). The default is 42° F (5.5° C).
- "CYCLE TIME" can be adjusted from 5 to 20 minutes. The default is 5 minutes.
- "ACTIVE TIME" can be adjusted from 15 to 120 minutes. The default is 60 minutes.

Enter "Advanced" menus, then proceed

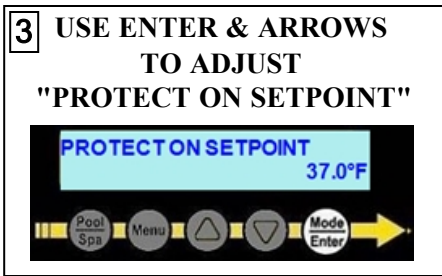
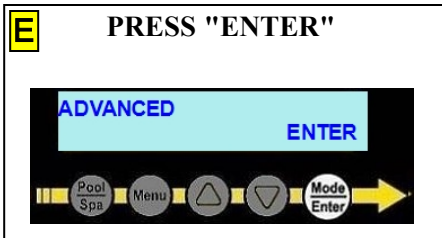
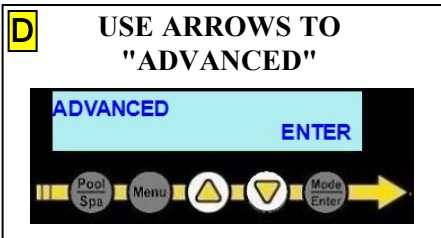
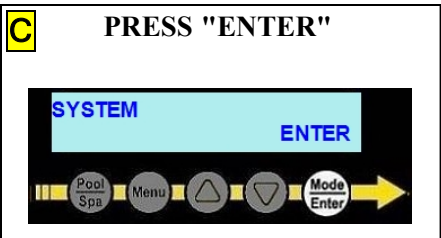
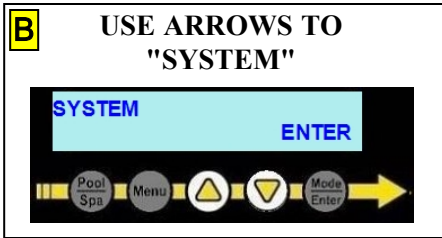
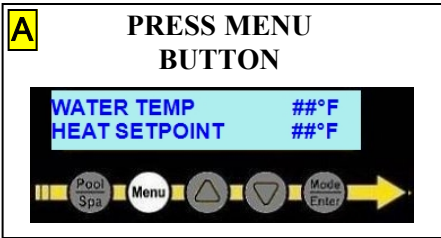
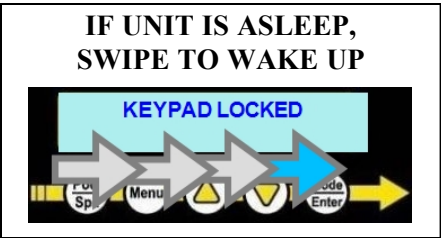

4 USE ENTER & ARROWS TO ADJUST "PROTECT OFF SETPOINT"

5 USE ENTER & ARROWS TO ADJUST "CYCLE TIME"

6 USE ENTER & ARROWS TO ADJUST "ACTIVE TIME"

MENU TO EXIT, PRESS & HOLD TO STATUS

2.10 FS2 Turbo Boost Enable (Select Units)

This feature is for a heat pump with a variable speed compressor only. A properly installed flow switch is required. See "Spa Turbo Boost Flow Switch Kit (# STK0244)" on page 108.

When the FS2 Turbo Boost Feature is enabled, the heat pump will automatically operate at a higher compressor speed when the spa is being used. Allowing the spa to heat rapidly.

PLEASE NOTE

This setup will most likely be required when a third party external controller is used.

- The efficiency algorithm controlling the compressor speed of a variable speed heat pump does not recognize when most automated controllers change from the pool mode to the spa mode. Therefore, the compressor may continue to operate at a lower speed; which can increase the time required to heat the spa.

Enter "Advanced" menus, then proceed

IF UNIT IS ASLEEP, SWIPE TO WAKE UP

A PRESS MENU BUTTON

B USE ARROWS TO "SYSTEM"

C PRESS "ENTER"

D USE ARROWS TO "ADVANCED"

E PRESS "ENTER"

1 USE ARROWS TO MENU "EFFICIENCY"

2 ENTER TO EDIT

3 ARROW TO "FS2 TURBO BOOST ENABLE"

4 ENTER TO EDIT

5 USE ARROWS TO CHANGE TO "ON"

6 ENTER TO SAVE

MENU TO EXIT, PRESS & HOLD TO STATUS

2.11 Identifying Model Specifications

1. Find Data Plate - The data plate is usually posted on the side of the equipment or the inside of the heat pump's access plate.
2. Find the model number on the data plate. The first letters and numbers indicate the model type.
3. The complete model number identifies the equipment's specifications.

Data Plate Example

MINIMUM CIRCUIT AMPACITY	<input type="text"/>	MADE IN THE USA
ELEC. SERVICE: VOLTS	<input type="text"/>	PH <input type="text"/> HZ <input type="text"/>
MAXIMUM TIME DELAY FUSE OR HACR BREAKER	<input type="text"/>	5
COMPRESSOR VOLTS	<input type="text"/>	R.L.A. <input type="text"/> L.R.A. <input type="text"/>
FAN MOTOR VOLTS	<input type="text"/>	H.P. <input type="text"/> F.L.A. <input type="text"/>
REFRIGERANT: Circuit - Factory charged	<input type="text"/>	Only oz/Kg <input type="text"/>
Tested to <input type="text"/> psig High side / <input type="text"/> psig Low side		
OUTDOOR USE		
AQUA CAL, INC. A TEAM HORNER COMPANY 2737 24 TH STREET NORTH ST. PETERSBURG, FL 33713 FACTORY SERVICE 727-523-5642	MODEL NUMBER <input type="text"/>	IIIBAR CODEIII
	SERIAL NUMBER <input type="text"/>	IIIBAR CODEIII

Model Number Example

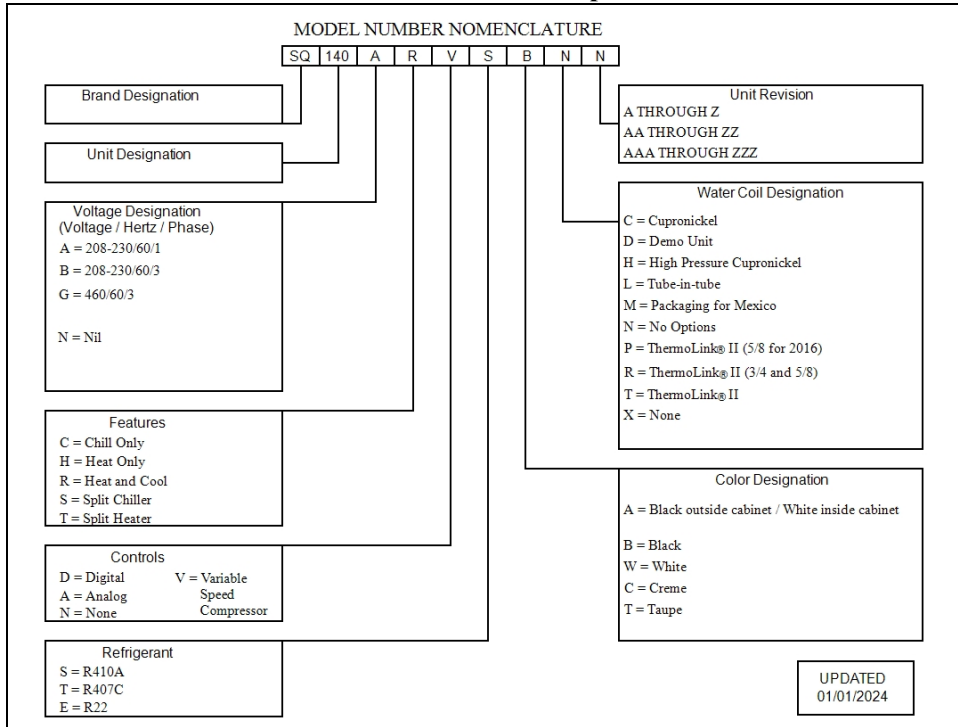

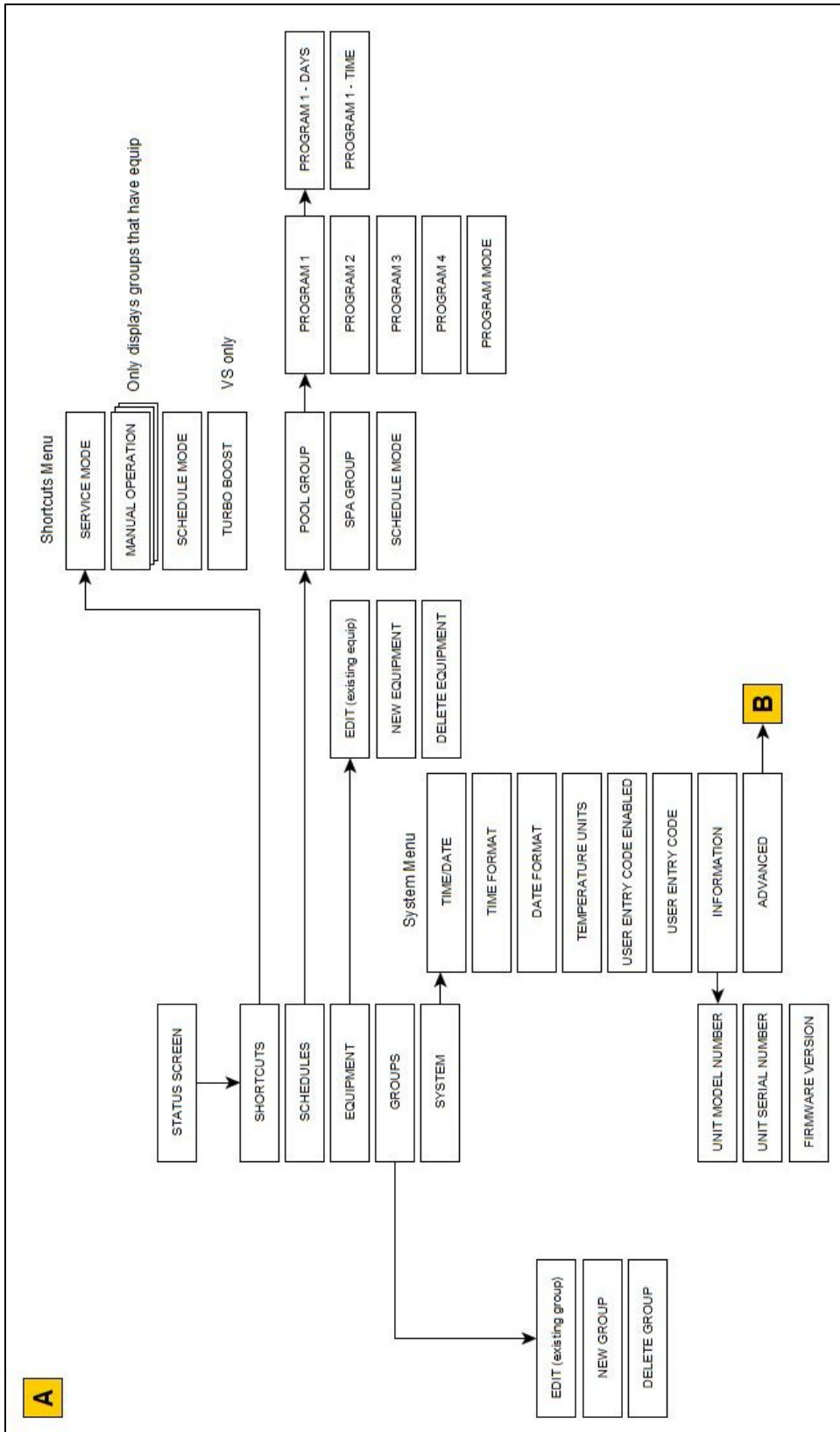

B

ADVANCED

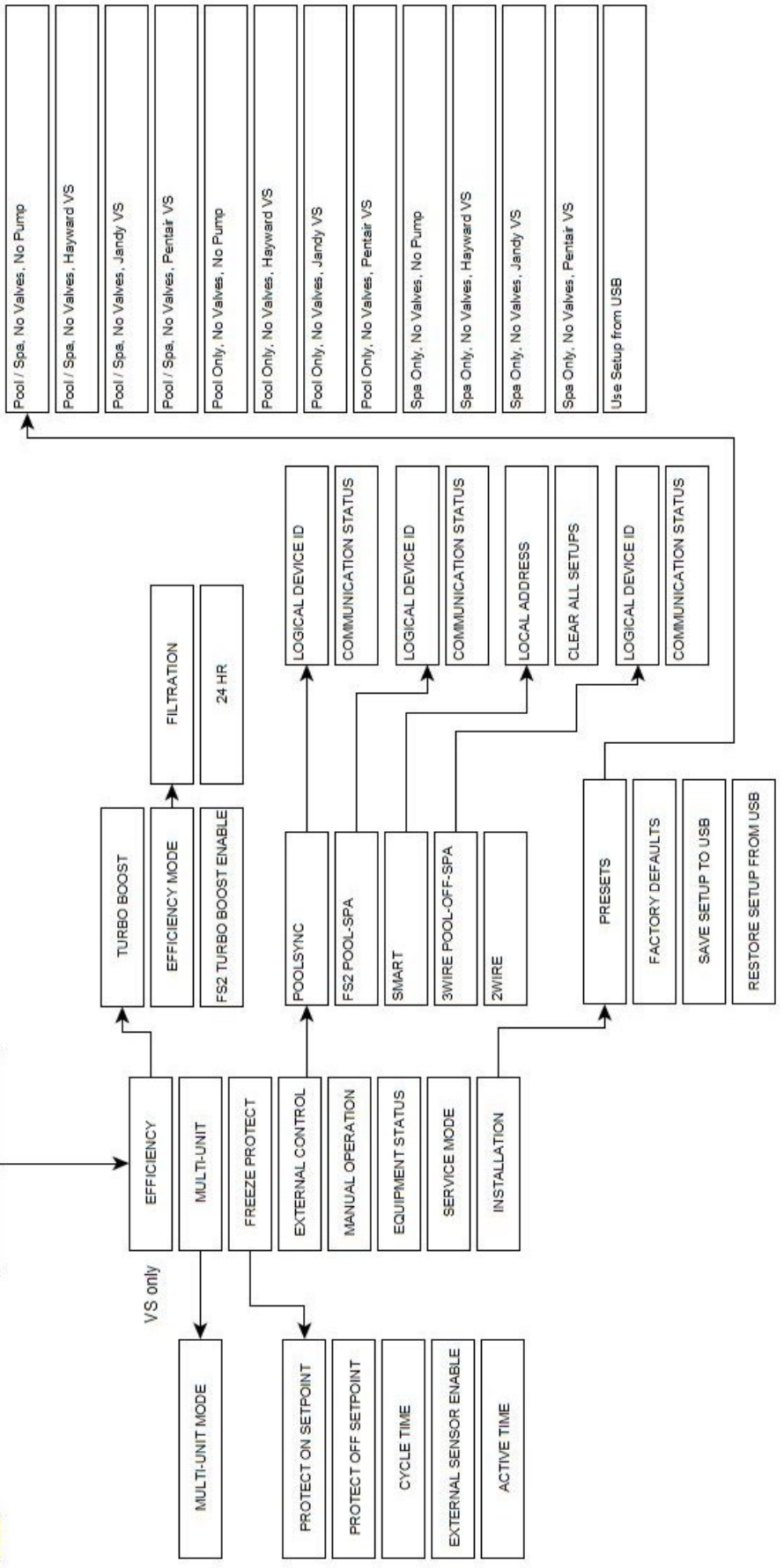

2.13 Three-Phase Adjustment

DANGER

Failure to heed the following will result in injury or death.

- Deactivate power while routing wiring to control board.
- RISK OF ELECTRICAL SHOCK FROM ENERGY STORED IN CAPACITORS - MODELS EQUIPPED WITH VARIABLE FREQUENCY COMPRESSOR DRIVES STORE ELECTRICITY EVEN AFTER THE POWER HAS BEEN DEACTIVATED AT THE POWER BREAKER. *Wait for 2 minutes after the shut down of equipment before servicing.*
- Follow all National Electric Codes (NEC) and/or State and Local guidelines.

WARNING

Failure to heed the following may result in injury or death.

- The information contained in this section is intended for use by qualified technicians, familiar with electrical service-industry safety standards and methods.

If a three-phase unit fails to operate at start-up, the orientation of the line voltage "field" wiring may need to be adjusted.

- The phase monitor is located inside the electrical panel.
1. Deactivate power to the unit. **Confirm that power is off to all three legs using an electrical test meter set for the correct voltage.**
 2. Switch position of the incoming power wires at each leg as follows, re-connect power and attempt to restart the unit. If the unit fails to start, disconnect power. Verify off and proceed to the next leg.
 - Switch incoming power wires at L1 and L2 on the line side to the contactor.
 - Switch incoming power wires at L1 and L3 on the line side to the contactor.
 - Switch incoming power wires at L2 and L3 on the line side to the contactor.
 3. When heat pump starts, disconnect power and verify off. Then confirm all line voltage connections are securely tightened. Reconnect power.
 - If the heat pump does not start, contact AquaCal® for further assistance. See "**Contacting AquaCal AutoPilot, Inc.**".

Three-Phase Monitor



2.14 Viewing System Information

The heat pump model, serial number, and firmware version can be viewed in the information menus.

Enter "System" menus, then proceed

<p>IF UNIT IS ASLEEP, SWIPE TO WAKE UP</p>	<p>A PRESS MENU BUTTON</p>	<p>B USE ARROWS TO "SYSTEM"</p>
---------------------------------------------------	-----------------------------------	----------------------------------------

C PRESS "ENTER"

1 USE ARROWS TO MENU "INFORMATION"

2 PRESS ENTER TO VIEW

3 USE ARROWS TO VIEW "UNIT SERIAL NUMBER"

4 USE ARROWS TO VIEW "UNIT MODEL NUMBER"

5 USE ARROWS TO VIEW "FIRMWARE VERSION"

MENU TO EXIT, PRESS & HOLD TO STATUS

2.15 Weights

NOTE:

Specifications subject to change.

Model Type	Model Number	Install Weight
TropiCal [®] Inverter	SQ160	287 Pounds (130 kg)
HeatWave SuperQuiet [®]	SQ140	268 Pounds (121.6 kg)
HeatWave SuperQuiet [®]	SQ200	328 Pounds (148.8 kg)
TropiCool [®]	TC1000	285 Pounds (128.8 kg)
TropiCool [®]	TC1500	328 Pounds (148.8 kg)

2.16 RPM Adjustments

The revolutions per minute (RPMs) can be adjusted on variable speed circulation pumps as required for site conditions.

NOTICE

Failure to heed the following may result in damage to equipment.

- Configuring an incorrect RPM will effect heat performance, filtration performance, and possibly cause damage to equipment. This is not covered by AquaCal warranties.
- **RPM for groups** - An adjustment can be made for each individual group that contains a variable speed circulation pump. See "*RPM adjustment (for groups)*" below. *A group controlling a water feature, for example, can have a different operating RPM than a pool group.*

PLEASE NOTE:

This RPM is only applicable to a groups normal operating state without an actively heating or cooling heat pump and after any priming RPM of a circulation pump.





- **RPM for the heat pump's active heat / cool speed** - The RPMs can be adjusted to provide the most efficient operation of the heat pump. See "*RPM adjustment (for heat pump active heating or cooling)*" on the facing page. This is a global setting for this piece of equipment. Once entered, the heat pump will use this RPM when active. Once the heat pump is satisfied, the RPM will again use the group's normal RPM setting.

PLEASE NOTE:

Variable speed circulation pump's also have a priming speed that is effective upon start up. After the pump is primed, the regular RPM speed for the group or the heat pump's heat / cool speed is activated.

RPM adjustment (for groups)

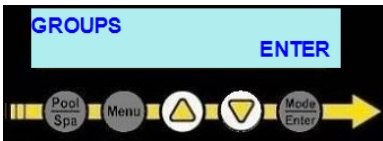
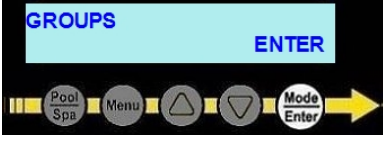
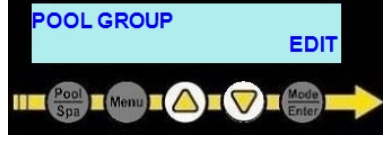
Enter "Groups" menus, then proceed

<p>IF UNIT IS ASLEEP, SWIPE TO WAKE UP</p> 	<p>A PRESS "MENU" BUTTON</p> 	<p>B USE ARROWS TO "GROUPS"</p> 
<p>C PRESS "ENTER"</p> 	<p>1 USE ARROWS TO APPROPRIATE GROUP</p> 	<p>2 ENTER TO EDIT</p> 

3 USE ARROWS TO APPROPRIATE PUMP

4 ENTER TO EDIT

5 ARROWS TO CHANGE

5 ENTER TO SAVE

MENU TO EXIT, PRESS & HOLD TO STATUS

RPM adjustment (for heat pump active heating or cooling)

Enter "Equipment" menus, then proceed

IF UNIT IS ASLEEP, SWIPE TO WAKE UP

A PRESS MENU BUTTON

B USE ARROWS TO "EQUIPMENT"

C PRESS "ENTER"

1 USE ARROWS TO APPROPRIATE PUMP

2 ENTER TO EDIT

3 USE ARROWS TO "HEAT/COOL SPEED"

4 ENTER TO EDIT

5 USE ARROWS TO CHANGE

6 PRESS ENTER TO SAVE

MENU TO EXIT, PRESS & HOLD TO STATUS

2.17 Saving Installer Settings to USB

Heat Pump settings can be saved to a USB thumb drive for later usage. This is particularly helpful to an installer that uses the same equipment and configurations on future installations.

DANGER

Failure to heed the following will result in injury or death.

- Deactivate power while routing wiring to control board.
- **RISK OF ELECTRICAL SHOCK FROM ENERGY STORED IN CAPACITORS - MODELS EQUIPPED WITH VARIABLE FREQUENCY COMPRESSOR DRIVES STORE ELECTRICITY EVEN AFTER THE POWER HAS BEEN DEACTIVATED AT THE POWER BREAKER. *Wait for 2 minutes after the shut down of equipment before servicing.***
- Follow all National Electric Codes (NEC) and/or State and Local guidelines.

Steps to save configuration to a thumb drive:

1. Deactivate power to heat pump.
2. ***Wait two minutes for capacitors to discharge.***
3. Remove heat pump's electrical access panel.
4. Plug USB thumb drive into port as indicated. See Figure 1.
5. Activate power to heat pump. Do not touch thumb drive or electrical components inside heat pump. A risk of electrical shock can occur resulting in injury or death.
6. Perform save to thumb drive operation.
7. Deactivate power to heat pump.
8. ***Wait two minutes for capacitors to discharge.***
9. Remove thumb drive and label for future usage.
10. Reinstall heat pump's electrical access panel.

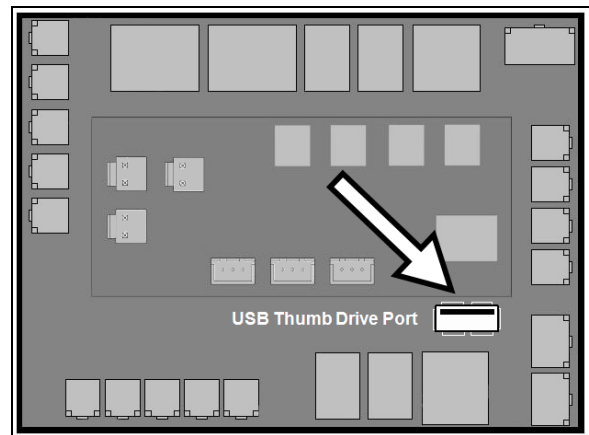
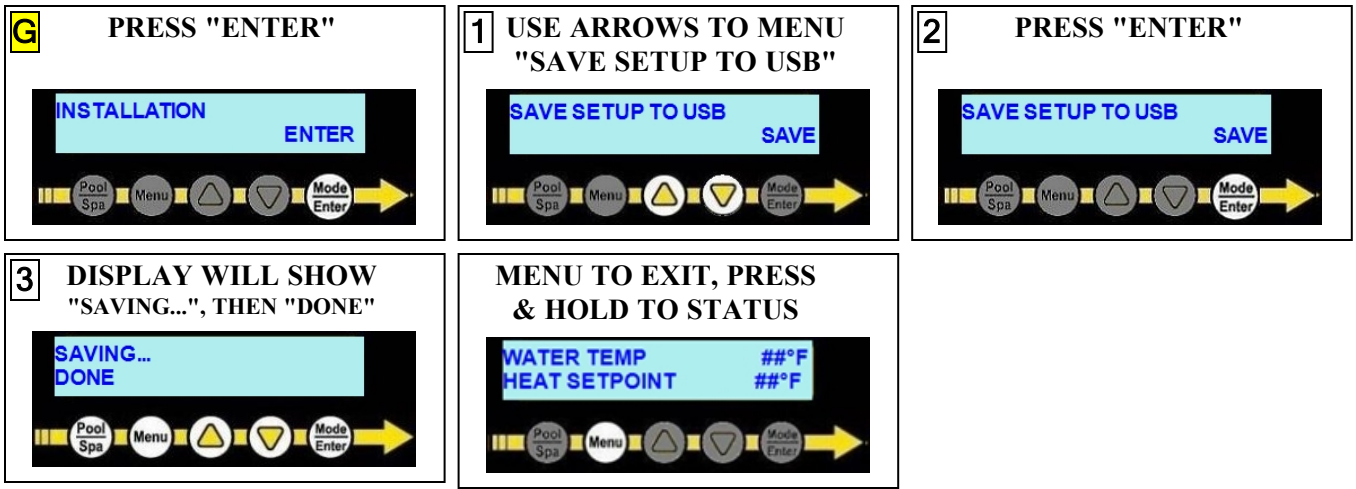

Figure 11 - USB Thumb Drive Port

Saving to USB

A PRESS MENU BUTTON WATER TEMP ##°F HEAT SETPOINT ##°F	B USE ARROWS TO "SYSTEM" SYSTEM ENTER	C PRESS "ENTER" SYSTEM ENTER
D USE ARROWS TO "ADVANCED" ADVANCED ENTER	E PRESS "ENTER" ADVANCED ENTER	F USE ARROWS TO "INSTALLATION" INSTALLATION ENTER



2.18 Initial Heating Recommendations

The following recommendations will reduce the amount of time required to heat a pool. **If unsure of equipment heating capability, review equipment data plate.** See "Identifying Model Specifications".

1. Use the heat pump's "POOL/SPA" button to select the "POOL" group.
2. Select 48HR (48 hours) for the "SET TIME".
3. Confirm the mode has been set to "HEAT" mode.
4. Set the desired temperature "HEAT SETPOINT" for the water.
5. If a circulation pump has been connected to the heat pump, it will automatically activate.
6. Activate Turbo Boost Mode if equipped.
7. Use a pool cover or blanket to reduce heating time.

2.19 Initial Cooling Recommendations









The following recommendations will reduce the amount of time required to cool a pool or cold plunge application. **If unsure of equipment cooling capability, review equipment data plate.** See "Identifying Model Specifications".

1. Use the heat pump's "POOL/SPA" button to select the "POOL" group.
2. Select 48HR (48 hours) for the "SET TIME".
3. Confirm the mode has been set to "COOL" mode.
4. Set the desired temperature "COOL SETPOINT" for the water.
5. If a circulation pump has been connected to the heat pump, it will automatically activate.
6. Activate Turbo Boost Mode if equipped.

2.20 Service Mode

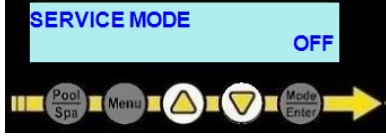
The heat pump can be set into a service mode where all connected devices including the heat pump can be deactivated for servicing. While in service mode, connected devices / equipment can be manually activated as needed.

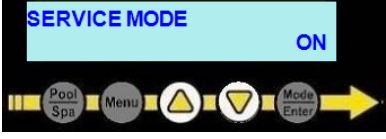
Enter "Shortcuts" menus, then proceed

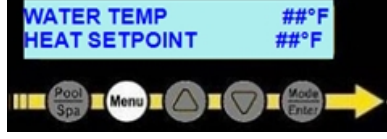
<p>IF UNIT IS ASLEEP, SWIPE TO WAKE UP</p> 	<p>A PRESS MENU BUTTON</p> 	<p>B USE ARROWS TO "SHORTCUTS"</p> 
<p>C PRESS "ENTER"</p> 	<p>1 USE ARROWS TO MENU "SERVICE MODE"</p> 	<p>2 PRESS ENTER TO EDIT</p> 
<p>3 USE ARROWS TO "ON"</p> 	<p>4 ENTER TO SAVE</p> 	<p>MENU TO EXIT, PRESS & HOLD TO STATUS</p> 

When service is complete, repeat above steps setting SERVICE MODE to "OFF".

2.21 Winterizing

Failure to properly winterize the heat pump as needed may result in serious equipment damage.

⚠ DANGER

Failure to heed the following will result in injury or death.

- Deactivate power while routing wiring to control board.
- RISK OF ELECTRICAL SHOCK FROM ENERGY STORED IN CAPACITORS - MODELS EQUIPPED WITH VARIABLE FREQUENCY COMPRESSOR DRIVES STORE ELECTRICITY EVEN AFTER THE POWER HAS BEEN DEACTIVATED AT THE POWER BREAKER. ***Wait for 2 minutes after the shut down of equipment before servicing.***
- Follow all National Electric Codes (NEC) and/or State and Local guidelines.

⚠ WARNING

Failure to heed the following may result in injury or death.

- Deactivate all electrical power to heat pump before performing hard freeze procedures.

NOTICE

Failure to heed the following may result in damage to equipment.

- Failure to winterize heat pump may result in serious equipment damage. Freeze damage is not covered under the heat pump warranty.
- While the plumbing connections are in the winterized condition (not fully tightened), it is imperative that water not run through the heat pump. Loss of water through loose plumbing connections may result in damage to circulation pump, pool and spa structures, and other equipment.

Light Freeze Conditions

A light freeze is when the ambient air temperature falls below 32 degrees Fahrenheit (0° C) for less than 8 hours. Typically during light freeze conditions circulating (or moving) water will not freeze. Temporarily activate the filter pump for continuous operation during light freeze conditions. If the heat pump is directly controlling a water circulation pump, any groups marked as requiring freeze protection will automatically have water circulated to the equipment. See "*Freeze Protection*" on page 92.

Hard Freeze Conditions

A hard freeze is when the ambient air temperature falls below 32 degrees Fahrenheit (0° C) for more than 8 hours. In areas where this condition is prevalent and sustained, the heat pump **MUST** be winterized for hard freeze conditions. Follow the correct procedure depending on the type of heat exchanger found in the heat pump.

Titanium ThermoLink[®] Exchanger (with no Drain)

1. Disconnect the plumbing to the heat pump at connection unions (removal is counter-clockwise).
2. Allow water to drain completely from the heat pump. Expect to see a lot of water drain out at first, and then a small amount to continue to drain out over a long period.
3. After heat pump has fully drained, partially reconnect plumbing connection unions.
4. Winterizing is complete.
5. When ready to use the heat pump again, hand-tighten connection unions. Reconnect electrical power, and set the operating mode on the heat pump. Activate the filter pump.

No Drain

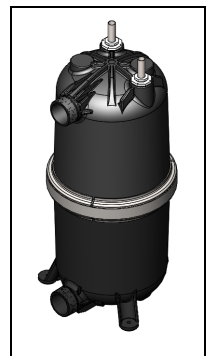

Titanium Tube-in-Tube Exchanger

1. Disconnect the plumbing to the heat pump at connection unions (removal is counter-clockwise).
2. Allow water to drain completely from the heat pump. Expect to see a lot of water drain out at first, and then a small amount to continue to drain out over a long period.

**Titanium
Tube-in-
Tube**

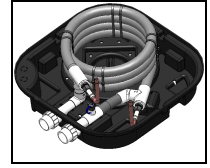

3. Place an air hose into the water inlet of the heat pump; wrap a clean rag around the hose to form a temporary seal.
4. Push all water from the water circuit using compressed air no stronger than 50 psig (446 kPa). The residual water should be forced out of the heat pump's water outlet. Allow compressed air to blow into the heat pump inlet for at least 15-20 seconds after the water stops coming out.

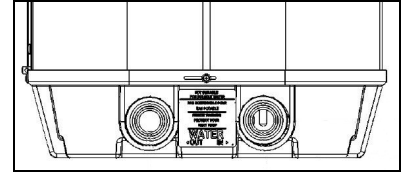

5. Repeat process on the outlet side of the heat pump.
6. Partially reconnect plumbing connection unions.
7. Winterizing is complete.
8. When ready to use the heat pump again, hand-tighten connection unions. Reconnect electrical power, and set the operating mode on the heat pump. Activate the filter pump.

2.22 Available Accessories

Accessories may be purchased through an authorized dealer of AquaCal® products.

Bypass Valve Kit (# STK0135)

- When high flow rates are outside recommended specifications, please use this kit or an alternative bypass valve system.
- This kit can be used to control excessive water flow through the heat pump. It provides automatic flow adjustments for most applications.



Condensation Drain Kit (# STK0202)

- Used when condensation water flow must be directed to a specific location.



Expansion Board Upgrade Kit (# STK0247)

- This kit contains an upgrade board that will give the heat pump direct control of actuators, circulation pumps, and relay-controlled devices.

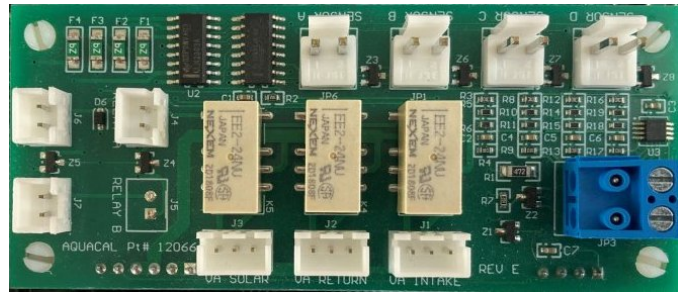

Spa Turbo Boost Flow Switch Kit (# STK0244)

- This kit is used to allow for rapid heating of a Spa when a variable speed heat pump is controlled by certain Automation Systems.

Grid Flow Switch (# 0040S)

- Used for automatic pool/spa thermostat switching.
- This switch can also be used in place of the water pressure switch. This may be needed when the pool/spa elevation is higher than the heat pump. A higher elevation of the water can cause a false signal to the heat pump; indicating water is flowing through the heat pump when it isn't.
- This kit is not to be used on applications exceeding 50 PSI (345 kPa).



Liquid Blankets

- An invisible liquid heat barrier designed to retain heat and extend the swimming season.
- AquaCal® recommends Lo-Chlor® Aqua Blanket™.



Plumbing Unions

- 2 Inch Unions - (# PLS2627)



PoolSync® WiFi Controller (ECP0343)

- This kit will add WiFi control capabilities to the heat pump.
- Contact installing dealer to order this product.



Temperature Port Kit (# STK0096)

- This port can be used to adjust water flow using Delta-T.
- The kit comes with port, installation components, and a temperature probe.



3 - Troubleshooting

DANGER

Failure to heed the following will result in injury or death.

- Deactivate power while routing wiring to control board.
- RISK OF ELECTRICAL SHOCK FROM ENERGY STORED IN CAPACITORS - MODELS EQUIPPED WITH VARIABLE FREQUENCY COMPRESSOR DRIVES STORE ELECTRICITY EVEN AFTER THE POWER HAS BEEN DEACTIVATED AT THE POWER BREAKER. ***Wait for 2 minutes after the shut down of equipment before servicing.***
- Follow all National Electric Codes (NEC) and/or State and Local guidelines.

WARNING

Failure to heed the following may result in injury or death.

- Repairs must not be attempted by untrained or unqualified individuals.
- The heat pump contains refrigerant under high pressure. Repairs to the refrigerant circuit must not be attempted by untrained or unqualified individuals. Service must be performed only by qualified HVAC technicians. Recover refrigerant before opening the system.

NOTICE

Failure to heed the following may result in damage to equipment.

- Service by unauthorized personnel will void the heat pump warranty.

IN THIS SECTION:**Fault Codes**

CLOCK LOW BATTERY	112
DEFROST1 SENSOR OPEN or DEFROST2 SENSOR OPEN	112
DEFROST1 SENSOR SHORT or DEFROST2 SENSOR SHORT	112
ERROR AT PRIMARY UNIT	112
HAYWARD VS PUMP FAULT	112
JANDY VS PUMP FAULT	112
PENTAIR VS PUMP FAULT	113
HIGH PRESSURE FAULT	113
HIGH WATER TEMP	114
HP5 SYSTEM LOCKOUT	114
HPC TEMP SYSTEM LOCKOUT	114
LOW PRESSURE FAULT	115
LP5 SYSTEM LOCKOUT	115
MULTI-UNIT COMM FAULT	115
NO POOL/SPA GROUP EXISTS	116
SMART COMM FAULT	116
VARIABLE DRIVE FAULT	116
WATER TEMP1 SENSOR SHORT or WATER TEMP1 SENSOR OPEN	116
WATER TEMP2 SENSOR SHORT or WATER TEMP2 SENSOR OPEN	116

Issues and resolutions

Blank Display	117
Circulation Pump Won't Activate	117
Display Panel Not Responding	117
Displays "DEFROSTING"	118
Displays "FREEZE PROTECTION ACTIVE"	118
Displays "NO SYSTEM FIRMWARE"	118
Displays "NO POOL/SPA WATER FLOW"	119
Displays "SET TO SWITCH REMOTELY"	119
Displays "UNIT MODEL NUMBER"	119
Heat Pump Not Running	119
Heat Pump's Tripping Breaker	120
Heat Pump Won't Shut Off	120
Heat Pump Is Running, Not Heating	121
Heat Pump Is Running, Not Cooling	121
Ice Forming on the Heat Pump	122
"Pool / Spa" Button Isn't Working	122
Schedule Not Working	123
Water Coming From Heat Pump	123

3.1 Fault Codes

A fault code indicates a specific issue or condition that will require action before the equipment can resume operating.

Please perform the following troubleshooting.

If the issue persists, please contact the installing dealer for service.

CLOCK LOW BATTERY**ISSUE**

The real-time clock controller indicates a low battery condition.

- The time will reset to factory default.

RESOLUTION

A qualified technician should replace the battery. The date and time will need to be reset on the heat pump after replacement.

DEFROST1 SENSOR OPEN or DEFROST2 SENSOR OPEN**ISSUE**

Open defrost sensor.

RESOLUTION

A qualified technician should replace the defrost sensor.

DEFROST1 SENSOR SHORT or DEFROST2 SENSOR SHORT**ISSUE**

Shorted defrost sensor.

RESOLUTION

A qualified technician should replace the defrost sensor.

ERROR AT PRIMARY UNIT**ISSUE**

The heat pump is secondary to a primary heat pump that is displaying a fault code.

RESOLUTION

The error at the primary heat pump must be corrected before the secondary unit will resume operation.

HAYWARD VS PUMP FAULT**ISSUE**

The heat pump has either lost communication with a connected Hayward circulation pump. Or the Hayward pump needs attention.

RESOLUTION

Check circulation pump documentation for a resolution for that product.

JANDY VS PUMP FAULT**ISSUE**

The heat pump has either lost communication with a connected Jandy circulation pump. Or the Jandy pump needs attention.

RESOLUTION

Check circulation pump documentation for a resolution for that product.

PENTAIR VS PUMP FAULT

ISSUE

The heat pump has either lost communication with a connected Pentair water pump. Or the Pentair pump needs attention.

RESOLUTION

Check circulation pump documentation for a resolution for that product.

HIGH PRESSURE FAULT

ISSUE

The refrigerant system's high-pressure switch is showing as open.

RESOLUTION

Heat Only Units

Place heat pump in heating mode and perform the following troubleshooting.

Determine if an insufficient amount of water is being supplied to the equipment.

1. Confirm the filter pump is on.
2. If a multiple-speed filter pump is being used, run filter pump at a higher speed. Do not exceed the maximum flow rate for the model.
3. Confirm water is not being diverted away from the heat pump.
 - See "*Water Flow Rates*" on page 12.
 - See "*Adjusting Water Flow Using ΔT (Delta-T)*" on page 81.
4. The water pressure switch may be incorrectly calibrated.
 - See "*Adjusting Water Pressure Switch (Select Units)*" on page 82.

Heat and Cool Units (Reversing)

Place heat pump in heating mode and perform the following troubleshooting.

Determine if an insufficient amount of water is being supplied to the equipment.

1. Confirm the filter pump is on.
2. If a multiple-speed filter pump is being used, run filter pump at a higher speed. Do not exceed the maximum flow rate for the model.
3. Confirm water is not being diverted away from the heat pump.
 - See "*Water Flow Rates*" on page 12.
 - See "*Adjusting Water Flow Using ΔT (Delta-T)*" on page 81.
4. The water pressure switch may be incorrectly calibrated.
 - See "*Adjusting Water Pressure Switch (Select Units)*" on page 82.

HIGH WATER TEMP

ISSUE

Incoming water temperature has exceeded 108° F (42° C) and the unit has been deactivated. The heat pump will not operate until the incoming water temperature drops to 100° F (38° C) or lower.

RESOLUTION

1. Determine if a gas heater is sending water directly to the heat pump. This situation would need to be corrected before continuing.
2. If the **HIGH WATER TEMP** fault continues to display, the water temperature sensor may require replacement.

HP5 SYSTEM LOCKOUT

ISSUE

The heat pump has locked due to five high-pressure faults during one call for heating or cooling.

RESOLUTION

1. Deactivate then reactivate power to the heat pump to clear error.
2. Troubleshoot the high-pressure issue causing the error.
 - See "*HIGH PRESSURE FAULT*" on the previous page.

HPC TEMP SYSTEM LOCKOUT

ISSUE

The heat pump's controller board is overheating.

RESOLUTION

A qualified technician should be contacted to correct the issue.

LOW PRESSURE FAULT

ISSUE

The refrigerant system's low-pressure switch is showing as open.

RESOLUTION

Heat Only Units

Place heat pump in heating mode and perform the following troubleshooting.

1. Check for proper fan operation. If the fan is not operating, contact AquaCal® Technical Support.
2. Check for obstructed airflow around the heat pump.
 - See "Clearances"
3. Check for a dirty or blocked evaporator coil.
 - See "Cleaning Equipment After Installation" on page 1
4. Check for signs of heavy ice buildup on the coil.

Heat and Cool Units (Reversing)

Place heat pump in heating mode and perform the following troubleshooting.

1. Check for proper fan operation. If the fan is not operating, call for service.
2. Check for obstructed airflow around the heat pump.
 - See "Clearances"
3. Check for a dirty or blocked evaporator coil.
 - See "Cleaning Equipment After Installation" on page 1
4. Check for signs of heavy ice buildup on the coil.

LP5 SYSTEM LOCKOUT

ISSUE

The heat pump has locked due to five low-pressure faults during one call for heating or cooling.

RESOLUTION

1. Deactivate then reactivate power to the heat pump to clear error.
2. Troubleshoot the low-pressure issue causing the error.
 - See "*LOW PRESSURE FAULT*" above.

MULTI-UNIT COMM FAULT

ISSUE

Secondary heat pump is not receiving a signal from the primary heat pump.

RESOLUTION

1. Confirm the primary heat pump is operating correctly. If, for example, no power is supplied to the primary heat pump, an error will appear on the secondary heat pumps.
2. Confirm the heat pump is properly connected and configured to a primary unit.
 - See "*Connecting Multiple Heat Pumps (Optional)*" on page 50.

NO POOL/SPA GROUP EXISTS

ISSUE

When pushing the POOL/SPA button, the heat pump displays the message "NO POOL/SPA GROUP EXISTS".

RESOLUTION

- A POOL or SPA group is only created if a preset has been used. For simple systems with only one body of water, a preset is not required. (See "*Site Configuration Presets (Optional)*" on page 60 for more information.)

SMART COMM FAULT

ISSUE

Heat Pump is not receiving a signal from an external controller using a smart connection point.

RESOLUTION

1. Confirm a smart external controller is being used.
 - If not, set external controller mode to "none" instead of "SMART".
 - See "*Configure for Smart Controller*" on page 28.
2. Confirm connection points from the external controller to the heat pump are correctly configured.
 - See "*SMART Controllers*" on page 26.
3. If using a smart external controller, confirm the controller is correctly set to send signals to the heat pump. See manuals or guides provided with the external controller.

VARIABLE DRIVE FAULT

ISSUE

A problem was detected in the variable speed compressor.

RESOLUTION

Deactivate heat pump at power disconnect.

Wait for two minutes for the capacitors to discharge.

Then reactivate heat pump's power at disconnect. If error reoccurs, call for service.

WATER TEMP1 SENSOR SHORT or WATER TEMP1 SENSOR OPEN

ISSUE

Open or shorted water sensor.

RESOLUTION

A qualified technician should replace the water sensor. Until the sensor is replaced, the setpoint is limited to 96° F (35.5° C)

WATER TEMP2 SENSOR SHORT or WATER TEMP2 SENSOR OPEN

ISSUE

Open or shorted water sensor.

RESOLUTION

A qualified technician should replace the water sensor. Until the sensor is replaced, the setpoint is limited to 96° F (35.5° C)

3.2 Issues and Resolutions

Please perform the following troubleshooting.

For further assistance, please contact AquaCal. See "*Contacting AquaCal AutoPilot, Inc.*".

Blank Display

ISSUE

The Heat Pump may have an incoming power problem.

RESOLUTION

Confirm electrical power is being supplied to the heat pump from electrical disconnect(s).

Circulation Pump Won't Activate

ISSUE

A circulation pump controlled by the heat pump will not activate as needed.

RESOLUTION

1. Confirm circulation pump is included in any group that requires it. See "*Edit a Group*" on page 67.
2. Confirm the group containing the circulation pump has an appropriate schedule. See "*Edit a Schedule*" on page 71.
3. Confirm the schedule mode is set to "AUTO" and the scheduled program mode is set to "ON". See "*Schedule and Program Modes*" on page 73.

Display Panel Not Responding

ISSUE

The heat pump's display panel will not respond to user input.

RESOLUTION

1. If heat pump display shows "**UNDER REMOTE CONTROL**", use the external control device to control the heat pump.
2. If needed, check with the external controller manufacturer for further assistance using that device.

Displays "DEFROSTING"**ISSUE**

The heat pump has sensed the coil is icing up. See "*Ice Forming on the Heat Pump*" on page 122.

No action is required.

RESOLUTION**Heat Only Units - Passive Defrost**

When ice starts to form on the coil, the compressor will stop operating while the fan continues to operate.

- The coil will begin to warm to the surrounding air temperature. When the coil's temperature rises above 38° F (3.3° C), the compressor is restarted and heating resumes.
- If the coil's temperature remains below 38° F (3.3° C), the compressor will remain off.

Heat and Cool Units - Active Defrost

Hot refrigerant gas will be sent through the coil to rapidly remove ice or frost.

During this process, the melting of the ice may appear as steam coming off the heat pump. This is normal.

Displays "FREEZE PROTECTION ACTIVE"**ISSUE**

The heat pump has sensed the air temperature has dropped below 37° F (0° C). This is the default setpoint before the heat pump begins to circulate water to groups marked as needing freeze protection. The heat pump will not heat water in these conditions. (See "*Freeze Protection*" on page 92 for more information.)

NOTICE

Failure to heed the following may result in damage to equipment.

- Freeze protection is meant to be temporary. If freezing temperatures will continue for an extended time frame, the pool equipment ***must*** be winterized.

PLEASE NOTE:

This protection is only available for heat pumps that directly control a circulation pump.

Displays "NO SYSTEM FIRMWARE"**ISSUE**

The heat pump has encountered a software error.

RESOLUTION

Call for service.

Displays "NO POOL/SPA WATER FLOW"**ISSUE**

Low or no water detected. This is normal when the circulation pump is deactivated.

RESOLUTION

1. Confirm the filter pump is on.
2. If a multiple-speed filter pump is being used, run at a higher speed to determine if the error persists. Do not exceed the maximum flow rate for your model.
3. Confirm water is not being diverted away from the heat pump.
 - See "*Water Flow Rates*" on page 12.
 - See "*Adjusting Water Flow Using ΔT (Delta-T)*" on page 81.

Displays "SET TO SWITCH REMOTELY"**ISSUE**

If when pressing the "Pool / Spa" button the display flashes the message "**SET TO SWITCH REMOTELY**", the heat pump is using a remote relay switch or a 3-wire controller.

RESOLUTION

- The Pool and Spa thermostat automatically switch when using these modes.
- Operation manually will not be available when using these external devices. No action is required.

Displays "UNIT MODEL NUMBER"**ISSUE**

The heat pump has encountered a software error.

RESOLUTION

- The model number and serial number will need to be re-entered into the system. The system will then operate as normal.
- If the issue persists, please contact the installing dealer for service.

Heat Pump Not Running**ISSUE**

The heat pump will not run.

RESOLUTION

1. Confirm equipment is receiving power. Is the heat pump display illuminated?
 - If not, confirm the main breaker (located at the power supply panel) and the disconnect switch (located near the heat pump) are both turned on.
 - If the display still does not illuminate, it is recommended that the heat pump installer or electrician confirm the heat pump is receiving power.
2. Confirm correct mode is selected.
3. Confirm thermostat is set correctly.
 - When heating the water is desired, the thermostat should be set above the current water temperature.
 - When cooling the water is desired, the thermostat should be set below the current water temperature.
4. If an error code is displayed, diagnose and correct the cause of the code.
 - See "*Fault Codes*" on page 111.
5. If the heat pump is using an external controller, the heat pump may not be set correctly to accept the controller's signal.

Heat Pump's Tripping Breaker

ISSUE

The heat pump breaker(s) keeps tripping.

RESOLUTION

1. If AquaCal[®] heat pumps have been connected using a multiple heat pump configuration, the configuration may be incorrect. Please confirm settings or contact installer of equipment.
 - See "Connecting Multiple Heat Pumps (Optional)" on page 50.
2. Have an electrician confirm breakers are correct type, in good condition, and properly sized for the heat pump.

Heat Pump Won't Shut Off

ISSUE

The heat pump will not deactivate.

RESOLUTION

PLEASE NOTE

When the heat pump is set to off, the display will show the current water temperature or no water flow indicator.

1. Confirm the correct mode has been set on the heat pump.
2. Confirm the heat pump has reached the desired temperature set on the thermostat. The heat pump will continue to run until the set temperature is reached.
3. If the heat pump is using an external controller, it may not be set correctly. See the external controller's manual.

Heat Pump Is Running, Not Heating

ISSUE

The heat pump is running. But the water is not heating.

RESOLUTION

1. If the heat pump is using an external controller, confirm it is set correctly.
 - See operation manual for operating heat pump with an external controller.
 - If the heat pump is still not running correctly with this device, contact the installer of the device or the device's manufacturer for further assistance.
2. Confirm heat pump mode is set to heat.
3. Confirm thermostat is set to the desired water temperature.
4. Confirm valves are positioned to heat the correct body of water (either the pool or the spa). If heating a spa that overflows into a pool, confirm the spa is isolated when being heated (not flowing into the pool).
5. Confirm heat pump is transferring heat into the water.
 - Measure the temperature of air discharge coming out of the heat pump fan. If discharge air is between 8° to 10° F (4.4° to 5.6° C) colder than the outside ambient air, the heat pump is moving heat into the water.
6. If an error code is displayed, diagnose and correct cause of code.
 - See "*Fault Codes*" on page 111.
7. Confirm that the filter pump has a sufficient run-time. The heat pump will not run (or heat the water) without water flow.
8. If heating a spa, deactivate air blower or venturi (if equipped) to allow for quicker heating times. For pools, deactivate water features, such as slides, waterfalls, or fountains to allow water to retain heat. Use of a liquid pool blanket product, such as an Aqua Blanket™, can also compensate for excessive heat loss.

Heat Pump Is Running, Not Cooling

ISSUE

The heat pump is running. But the water is not cooling.

RESOLUTION

1. If the heat pump is using an external controller, confirm the heat pump is programmed properly to allow for cooling.
2. Confirm the heat pump mode is set to cool.
3. Confirm the thermostat is set below the current water temperature.
4. Confirm valves are positioned to cool the correct body of water (either the pool or the spa). If cooling a spa that overflows into a pool, confirm the spa is isolated when being cooled (not flowing into the pool).
5. If an error code is displayed, determine and correct the condition causing the code.
 - See "*Fault Codes*" on page 111.
6. Confirm heat pump is transferring heat out of the water.
 - Measure the temperature of air discharge coming out of the heat pump's fan. If the air is between 8° to 10° F (4.4° to 5.6° C) warmer than the outside ambient air, the heat pump is moving heat out of the water.
7. Confirm that the filter pump has a sufficient run-time. The heat pump will not run (or cool the water) without water flow.

Ice Forming on the Heat Pump

ISSUE

When conditions are too cold for proper operation, the heat pump will enter a defrost mode. This prevents ice from building up on the evaporator coil.

RESOLUTION

Heat Only Units:

- The heat pump may develop a fine layer of white frost on the outside coil before entering the defrost mode. This is normal.
 - See "*Displays Defrosting*" on page 118.
- If heavy ice (not frost) starts to build up, shut off the heat pump. Contact the installer or manufacturer.
- If the ambient air temperature will be falling below 32° F (0° C) for more than 8 hours, winterize equipment.

Heat and Cool Units (with Active Defrost or "Icebreaker"):

- During freezing conditions, pool or spa heating will continue. Frost or ice may develop during the "countdown" to the active defrost (up to 50 minutes). This is normal. See "*Displays Defrosting*" on page 118.
- The heat pump will enter an "active defrost" stage to remove the accumulated frost and ice.
 - Be sure to observe the unit for at least 50 minutes. If it has not entered an active defrost cycle, call for service.

TIP:

The heat pump can be manually set to defrost by temporarily switching to the cooling mode until the ice or frost melts.

- If the ambient air temperature is (or will be) falling below 32° F (0° C) for more than 8 hours, winterize equipment.

"Pool / Spa" Button Isn't Working

ISSUE

The "Pool / Spa" button is disabled if the following devices have been configured on the heat pump.

- A 2-wire external controller.
- A 3-wire external controller.
- A "SMART" external controller.
- An external flow switch.

RESOLUTION

If not used to operate the heat pump, deactivate the external control device.

Schedule Not Working**ISSUE**

A device isn't operating as scheduled.

RESOLUTION

- Confirm the group has an appropriate schedule program. See "*Edit a Schedule*" on page 71.
- Confirm the schedule mode is set to "AUTO" and the scheduled program mode is set to "ON". See "*Schedule and Program Modes*" on page 73.
- Confirm the time is set correctly in the system. See equipment manual for information on changing date and time on heat pump.

Water Coming From Heat Pump**ISSUE**

The water may be normal condensation produced as a by-product of the heat pump's refrigeration process.

The heat pump can produce up to 8 to 10 gallons (30 to 38 liters) of condensation per hour depending on the humidity of the ambient air. Determine if the water is condensation or a possible leak.

RESOLUTION

1. Deactivate heat pump, leaving the filter pump on. After several hours, determine if the water is still coming from the heat pump.
2. If using chlorine or bromine as a pool/spa sanitizer, test the water around the heat pump using a test strip. If the test strip indicates that chlorine or bromine is present, a leak may exist.

PLEASE NOTE -

If desired, a kit is available to re-direct condensation water away from the heat pump.

- See "*Condensation Drain Kit (# STK0202)*" on page 107.

