

FX | LUMINAIRE®
RS-20, RS-35



MULTIPLE LIGHTING
POSSIBILITIES

The ReflectoreStellato® is a rugged micro luminaire that provides the power and control of the halogen MR-16 lamp family. This patent pending, precision lighting instrument is a fine example of engineering for simplicity and reliability. Through the use of an O-ring hydraulic compression cap seal, the potentially troublesome threads and screws found in other spotlights are eliminated.

The ReflectoreStellato® is constructed without compromise using aerospace grade alloys and silicone seals. Because of its high efficiency, beam control, color rendition and availability, the MR-16 lamp family was chosen to power this luminaire.

With this broad range of illuminating possibilities the lighting designer can find an FX solution to most exterior lighting tasks.

Note: This fixture is designed for uplighting only.



UPLIGHTING
TREES



ARCHITECTURAL
ACCENTS



ENTRY
MONUMENTS

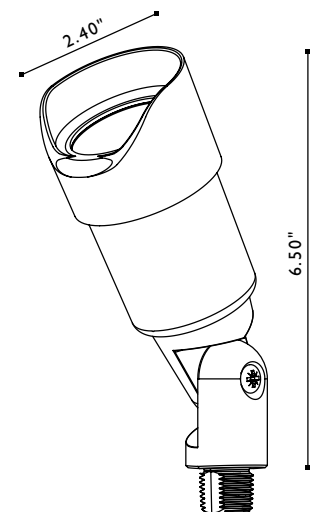

REFLECTORESTELLATO® – ORDERING INFORMATION

RS comes standard with a 20 watt MR-16 Halogen lamp, Clear or Frosted Lens (specify F after wattage, EX: RS-20-F-BZ.), Super Slot Spike®, and any finish.

STANDARD PARTS:

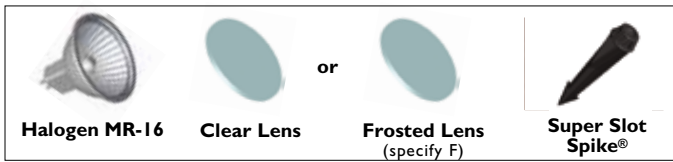

STANDARD OPTIONS:

1 + 2 + 3 ORDERED TOGETHER ON SAME LINE

STANDARD LAMP CONFIGURATIONS:

Choose from any watt Halogen (H).

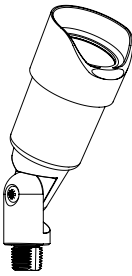





FIXTURE/CODE	WATTAGE/CODE	AVG. LIFE HOUR
	2 HALOGEN (H) LAMP OPTIONS:	
	20H	20 watt Halogen, wide, 36° beam, Avg. life 5000 hours; now available in 10000 hours <i>(new)</i>
	20V-H	20 watt Halogen, very narrow, 10° beam, Avg. life 4000 hours
	35H	35 watt Halogen, wide, 36° beam, Avg. life 5000 hours; now available in 10000 hours <i>(new)</i>
	35V-H	35 watt Halogen, very narrow, 10° beam, Avg. life 5000 hours

LAMP NOTE:

Some lamps are by special order. Please check with our factory for availability.

FINISH OPTIONS:

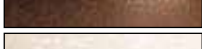
Allow extra time for the following finish options:

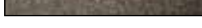
	3 BZ	Bronze Metallic
	DG	Desert Granite
	BF	Black Wrinkle
	VF	Verde Speckle
	SB	Sedona Brown
	WF	White Wrinkle
	WI	Weathered Iron

ORDERING SAMPLE:

SECTIONS:	DESCRIPTION:	WHAT TO ORDER:
1 + 2 + 3	 +	= RS-20-BZ
A, B and/or C		= HB
		= CDS

NON-STANDARD OPTIONS:

A, B AND C MUST BE ORDERED ON SEPARATE LINE!

ADDITIONAL GLARE CONTROL OPTIONS:

Does not come pre-assembled with glare control, they will arrive in separate box.

CODE	DESCRIPTION
A HB	HexBaffle®

ADDITIONAL LENS OPTIONS:

Comes pre-assembled with a clear lens. All others will arrive in separate box.

CODE	DESCRIPTION
B S	Spread Lens
SO	Solite Lens
CF-1	Peach Lens
CF-2	Blue Lens
CF-3	Green Lens
CF-4	Red Lens

ADDITIONAL MOUNTING OPTIONS:

Comes pre-assembled with Super Slot Spike®.

All other mounting options will arrive in separate box.

CODE	DESCRIPTION	SIZE
C CDS	CapannaDiNoce®	2.00" x 10.00"
SJ	SuperJ-boX®	2.50" x 12.00"
PM	PostMount®	2.50" x 13.00"