

99-55-4390000
INSTRUCTIONS

PRO SERIES REEL SYSTEM FOR INGROUND POOL



REGISTER WARRANTY ONLINE AT WWW.GLIPOOLPRODUCTS.COM.

PLEASE REGISTER WITHIN 10 DAYS OF PURCHASE.

IF YOU WISH TO MAKE A CLAIM, CALL TOLL FREE 1-800-448-2343.

FOR REPLACEMENT PARTS FOR YOUR REEL SYSTEM PLEASE VISIT, WWW.GLIPROMOTIONS.COM.



Youngstown, Ohio 44510 • www.glipoolproducts.com

INSTALLATION INSTRUCTIONS

1. Congratulations on your purchase of our PRO SERIES Solar Reel for Inground Pools. Please follow the instructions carefully so as to not void warranty.
2. Please use your solar blanket and reel assembly in the manner it was intended for:
 - a. Your solar blanket is not a safety cover
 - b. Remove the solar blanket and Solar Reel assembly from the pool completely before swimming use.
 - c. Do not store the solar blanket on the ground in direct sunlight, as it will burn the lawn
3. Preparation & Assembly: Check inventory of all items and assemble as illustrated below:

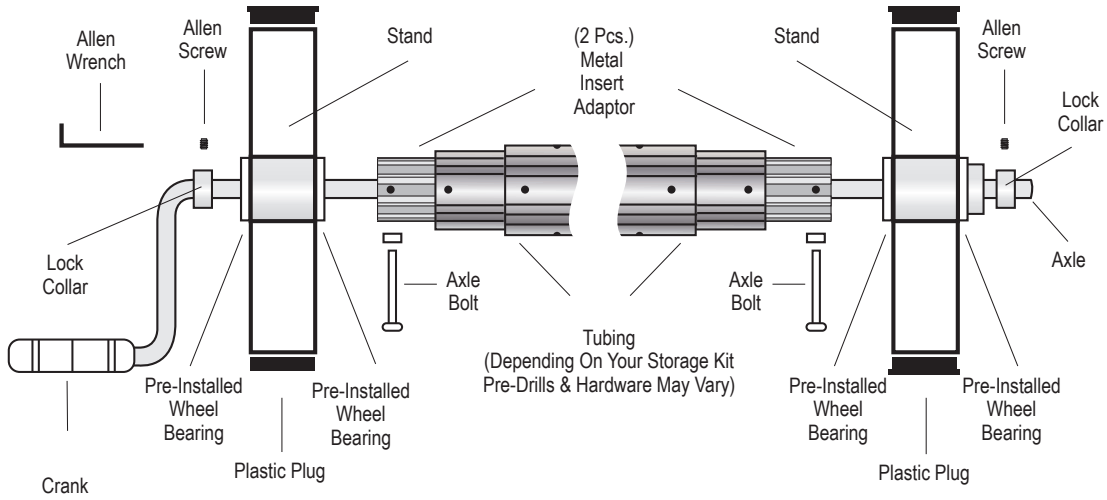

PARTS BREAKDOWN			
PART NUMBER	DESCRIPTION	QUANTITY	
1	99-55-4395007	12" Triangular fixed base stand with pre-installed bearings	2
--	99-55-4395012	Plastic End caps for stand (pre-installed) (not pictured)	4
2	99-55-4395009	Locking Collar	2
3	99-55-4395008	Crack handle with grip & lock collar	1
4	99-55-4395015	3" insert adaptor with axle and lock collar	1
5	99-55-4395014	3" insert adaptor	1
6	99-55-4395012	Allen key for locking collar	1
7	99-55-4395013	2.83" Axle bolt & nut	2
8	99-55-4395051	Rubber foot pads	1
9	99-55-4395015	Strap Kit	1

- STRAP KIT**
- (11 Pcs.) Plastic Screw (1 extra piece)
 - (21 Pcs.) Plastic Strap Plate (1 extra piece)
 - (11 Pcs.) Stainless Steel Self-Drilling Screws (1 extra piece)
 - (1 Pc.) Driver Bit
 - (10 Pcs.) Fabric Straps (1 extra piece)

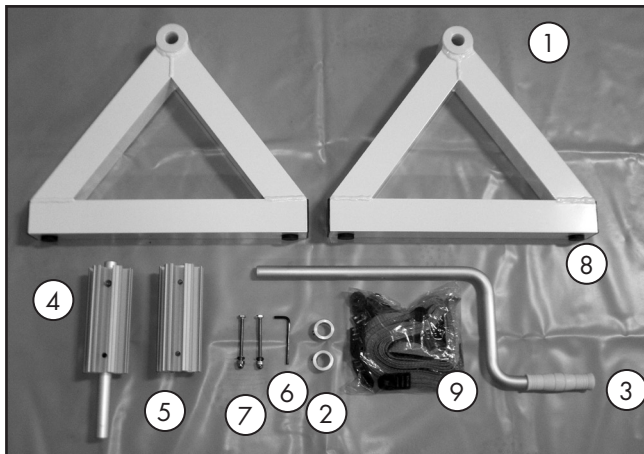
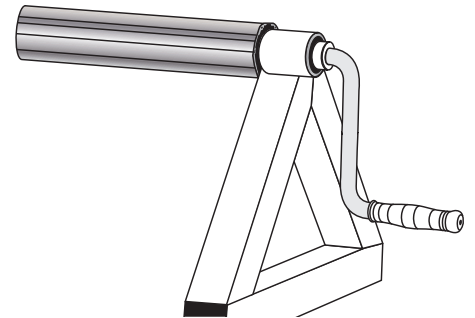

4. Depending upon the size of your pool you will also require one of the following storage kits: (Storage Kit Assembly is detailed below.)

PART # IGR4390012
12' X 3" IGR STORAGE KIT
 (2) 59.5" x 2.75" Dia. Inner Tube
 (1) 59.5" x 2.95" Dia. Outer Tube
 (4) 3" Through Bolt with Nut
 (1) Drill Bit
 Max. finished length = 13' 3/8"

PART # IGR4390016
16' X 3" IGR STORAGE KIT
 (2) 72" x 2.75" Dia. Inner Tube
 (1) 72" x 2.95" Dia. Outer Tube
 (4) 3" Through Bolt with Nut
 (1) Drill Bit
 Max. finished length = 16' 1/2"

PART # IGR4390002
20' X 3" IGR STORAGE KIT
 (3) 59.5" x 2.75" Dia. Inner Tube
 (2) 59.5" x 2.95" Dia. Outer Tube
 (8) 3" Through Bolt with Nut
 (1) Drill Bit
 Max. finished length = 21' 3/4"

PART # IGR4390420
20' X 4" IGR STORAGE KIT
 (3) 59.5" x 3.75" Dia. Inner Tube
 (2) 59.5" x 4.0" Dia. Outer Tube
 (8) 4" Through Bolt with Nut
 (2) 3.75" Axel Bolt with Nut
 (2) 4" insert adaptor
 (2) 4" resin insert adaptor
 (1) Drill Bit
 Maximum length = 21' 3/4"

PART # IGR4390024
24' X 4" IGR STORAGE KIT
 (4) 68" x 3.75" Dia. Inner Tube
 (3) 68" x 4.0" Dia. Outer Tube
 (12) 4" Through Bolt with Nut
 (2) 3.75" Axel Bolt with Nut
 (2) 4" insert adaptor
 (2) 4" resin insert adaptor
 (1) Drill Bit
 Max. finished length = 25' 3/8"

5. Positioning Your Solar Reel:

For Rectangular pools, place Stands at either end of pool. (See Fig. A)

For Irregular shaped pools, place Stands at some convenient midway point. You will need to fold Blanket and allow Blanket to unroll in two directions. (See Fig. B)

Fig. A

RECTANGULAR

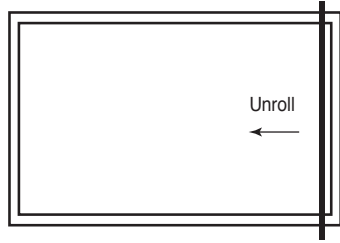
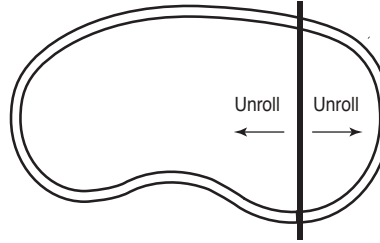

Fig. B

IRREGULAR



6. Trimming Your Solar Blanket:

- Lay your Solar Blanket (not provided) on top of water. **IMPORTANT!** Irregular Shaped Pools will need to have their solar covers folded at point of placement of Stands! The cover will unroll left and right of Stands & cross pole. Please allow 6 inches more material on length to allow for a fold where straps will be attached for wind onto reel system. (See Fig. B above)
- With scissors trim blanket to fit shape of pool. Be sure to clear pool edge coping.

7. Assembling The Storage Kit:

All Storage Kits consist of 6 sided Hexagon shaped tubing. There are two diameters of tubing, the smaller size nesting into the larger size. All storage kits begin and end with small tubes. The insert adaptor equires CAREFUL ALIGNMENT!

STORAGE KIT ASSEMBLY:

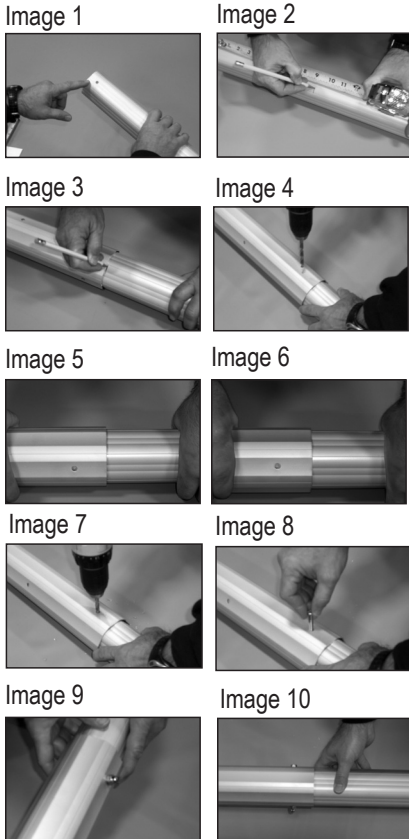

- All storage kits consist of hexagon shaped aluminum tubing. There are two diameters of tubing; the smaller diameter will insert into the larger diameter.
- Determine length of tube required for your installation. Note maximum finished length per storage kit size listed above (in Step 4).
Please note: Smaller diameter tube will be used on both ends of the reel and will connect to the base unit. Two of the smaller diameter tubes will have predrilled axle bolt holes on one end. The pre-drilled end will be connected to the base unit. (Image 1)
- Loosely assemble tubes together to match the desired length for your installation, evenly dividing the excess at each connection. Note that the smaller diameter tube must be inserted a minimum of 9" into the larger diameter tube at each connection. Tip: Measure in 9" from end of smaller diameter tube and make a mark with a pencil. (Image 2) The tube must be inserted at least to your pencil mark. It is ok if tube is inserted more than 9", but not less.
- Once you determine length and have proper spacing of tubes, mark each tube at the connection point for reference. (Image 3) This will eliminate the need to re-measure if your tubes get moved during the remainder of the installation process.
- Each connection will be fastened together with the through bolts supplied in your storage kit. Use the pre-drilled holes in the larger diameter tube as a guide to drill the smaller inner tube. (Image 4) Twist tubing to remove excess play prior to drilling holes. (Image 5 - Before Twisting, Image 6 - After Twisting) (Fig. C on last page) Drill from each side with the drill bit supplied. (Image 7)
- Fasten with 2 bolts and nuts at each connection. (Image 8, Image 9, Image 10)

Image 11



Image 12



Image 13



Image 14

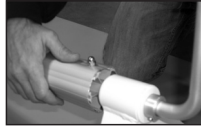

Image 15

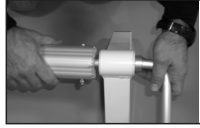

Image 16



Image 17

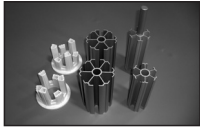

Image 18

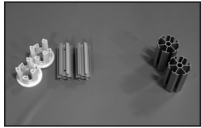

Image 19

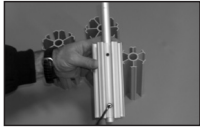

Image 20

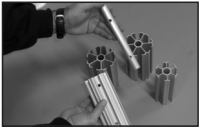

Image 21



Image 22



Image 23



Image 24



3" DIAMETER STORAGE KITS:

(If you have purchased a 4" diameter storage kit, go to 4" diameter storage kit instructions below.)

- Attach tube assembly to base unit.
- The aluminum tube insert must be inserted into the end of the tube. (Image 11) Be sure to align axle hole in the aluminum tube insert with the pre-drilled axle hole on the tube.
- Insert Crank handle through the base unit and into the aluminum tube insert. Be sure to align axle hole. (Image 12)
- Fasten tube to base unit using the 2.83" axle bolt that is packaged with your base kit. (Image 13, Image 14, Image 15)
- Align and tighten locking collar with allen wrench. (Image 16)
- Repeat same procedure on opposite end using insert with axle.

4" DIAMETER STORAGE KITS :

Note: The 4" storage kit is packaged with two large insert adaptors and two resin insert adaptors. See pictures of each. (Image 17) Note: Image 17 also includes the smaller insert adaptor that were packaged with the base kit.

You will use the large insert adaptor for your installation.

- Remove the two small insert adaptor from your base kit. One insert will have an axle pre-a. attached that will need removed and installed on one of the large insert adaptors. Remove the bolt from the small metal insert using the allen wrench and install the axle on one of the large insert adaptors. (Image 18, Image 19) The small bolt that holds the axle to the small aluminum tube insert will not be used with the large aluminum tube insert. The axle bolt itself will hold the assembly together on the axle end.
- The small aluminum inserts and the resin inserts can now be discarded as they will not be b. used.
- The tube insert must be inserted into the end of the tube. (Image 20) Be sure to align axle c. hole in the tube insert with the pre-drilled axle hole on the tube.
- Insert Crank handle through the base unit and into the tube insert. (Image 21) Be sure to d. align axle hole.
- Fasten tube to base unit using the 3.75" axle bolt that is packaged with your tube kit. (Image e. 22) Note: the 2.83" axle bolt that is packaged with your base kit can be discarded as it will not be used.
- Align and tighten locking collar with allen wrench. (Image 23)f.
- Repeat same procedure on opposite end using insert with axle.

8. Attach Straps to Tubes:

Come in 6 inches from each tube end and attach a strap plate to the aluminum tube assembly. Use the self drilling screws on the drill line to attach the plate. Look at the holes that were pre-drilled at the factory and use the same drill line. There are 6 lines on each tube. Take the remaining strap plates and connect them evenly along the length of the tube assembly. Attach straps to strap plate. (Fig. D)

9. Attach Solar Blanket to Straps:

If Reel is to be placed at the end of the pool, attach cover to strap plate with plastic screw. (Fig. E) If Reel is to be placed in offset position, then attach cover to strap plate forming a fold to act like a hinge and the plastic screw will go through two layers of the solar blanket. (Fig. F)

Bubbles should face down.

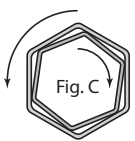

Twist Tubing To Remove Excess Play Prior To Screwing Together.



Thread Strap as Shown

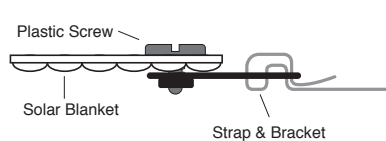

Fig. E

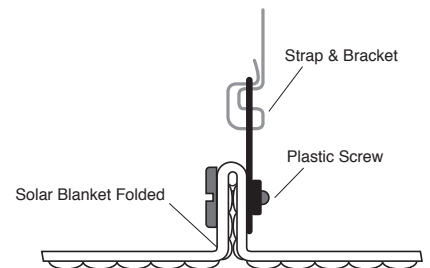

Fig. F

