

32" CHANNEL DRAIN ANTI-ENTRAPMENT SUCTION OUTLET  
COVER AND ABS THREE-PORT MANUFACTURED SUMP FOR VINYL



VGB CERTIFIED  
SPECIFICATIONS

**Floor Flow Rating**  
236 GPM at 3.4 fps

**Wall Flow Rating**  
136 GPM at 1.9 fps

**Sump Depth**  
*Use sump included*

**Open Area**  
22.6 in<sup>2</sup>

FEATURES

Meets or exceeds ANSI/APSP 16-2011 and NSF/ANSI 50-2009a national standards and ASTM G154 UV testing

Three ports: bottom 2½" OD, 2" ID S/S; inside 2" threaded FPT; two 2" threaded plugs included

Manufactured from superior UV-resistant engineered polymers

Permanently attached gasket reduces gasket alignment problems

Must use transitional glue when attaching to PVC pipe

#316 stainless steel screws

Replace drain cover every five years from the date of installation

1 per case



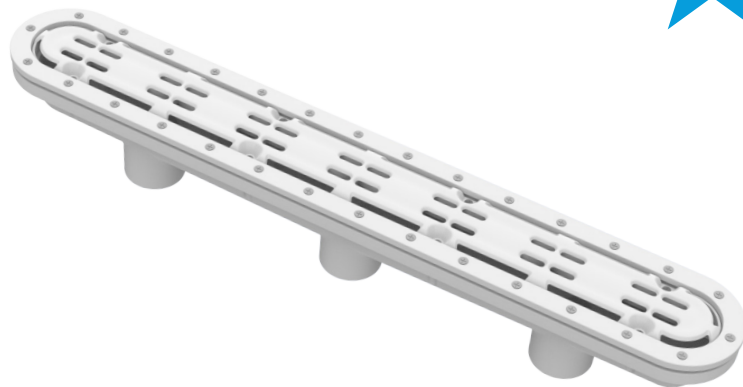



Unblockable!



Part # 32CDAVVxxx

Two drains in one!

STANDARD COLORS

-  32CDAVV101 – White
-  32CDAVV102 – Black
-  32CDAVV103 – Light Gray
-  32CDAVV104 – Blue
-  32CDAVV105 – Dark Gray
-  32CDAVV108 – Tan

Also available as cover only  
p/n 32CDAVNFxxx  
20 per case

Also available as sump only  
p/n 32CDSBV101  
4 per case

VGB 2008 Compliant

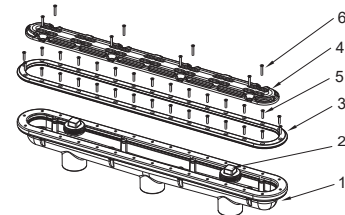
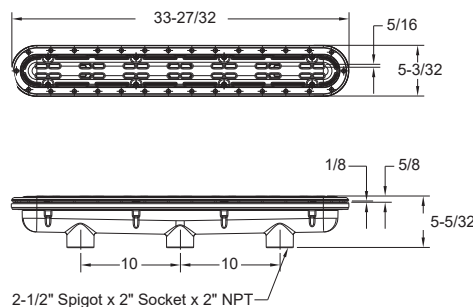

1. 32" Three-Port Manufactured Vinyl Sump Bucket With Gasket
2. 2" Tapered Threaded Pipe Plug, Qty 2
3. 32" Channel Drain Vinyl Clamping Ring With Gasket
4. 32" Anti-Entrapment Suction Outlet Cover
5. 10 x 1" Flat Head Phillips Screw, 316 SS, Qty 30
6. 10 x 1-1/4" Flat Head Phillips Screw, 316 SS, Qty 8