

12" Square SUN Suction Outlet Cover and Mud Frame

VGB Series

Product Specification Sheet

The AquaStar line of suction outlet covers, compliant with the new Virginia Graeme-Baker Pool and Spa Safety Act (ASME/ANSI A112.19.8a-2008)

Features

For single or multiple drain use
(see installation instructions)

Requires a minimum 3" sump depth

Floor: 280 GPM at 2.5 fps

Wall: 280 GPM at 2.5 fps

Floor/wall: 166 GPM at 1.5 fps

35.3 square inch opening

#316 stainless steel screws

The SUN Series has the lowest profile 9" x 9" and 12" x 12" VGB 2008 compliant suction outlets in the industry

Manufactured from superior UV-resistant engineered polymers

Easily and safely retrofits most brands' existing 12" frames* (see chart and installation instructions for details and special requirements)

Mud frame included for new construction

All components (cover, adapter plate, frame, screws) meet or exceed NSF 50/ASME/ANSI A112.19.8a-2008 national standards and ASTM G154 UV testing exposure

Listed with IAPMO R&T

12 per case

NEW SUN Series

Lowest profile – great for spas and wading pools!



Part # SUN12xxx

*Fits: AquaStar, Pentair #1, AquaStar pre-VGB (3/4" deep frames)

Part Numbers / Colors

- SUN12101 White
- SUN12102 Black
- SUN12103 Lt. Gray
- SUN12104 Blue
- SUN12105 Dk. Gray
- SUN12106 Bone
- SUN12107 Taupe
- SUN12108 Tan

VGB 2008 Compliant

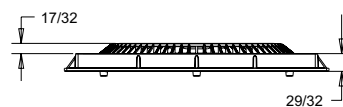
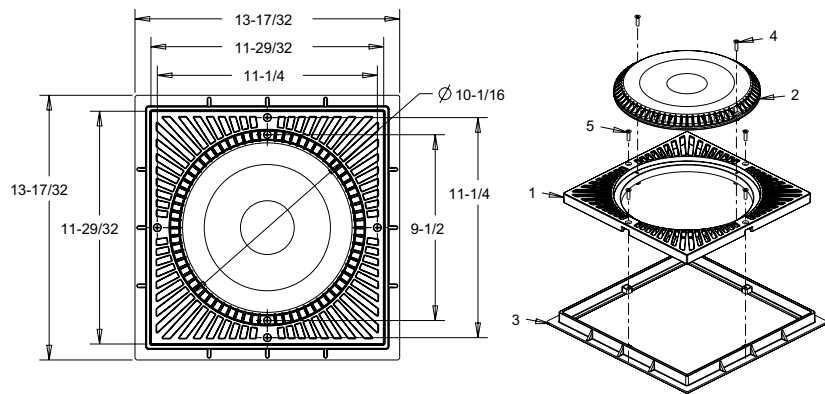

1. 12" shallow square "SUN" to 10" round adapter
2. 10" round anti-entrapment cover
3. 12" square drain frame
4. #10 x 3/4" flat head phillips screw, 316 ss
5. #10 x 3/4" flat head phillips screw, 316 ss

ADDITIONAL PRODUCT CONFIGURATIONS FOR SUN12xxx

Features: Sump Buckets for SUN12xxx

For single or multiple drain use (see installation instructions)

#316 stainless steel screws

The SUN Series has the lowest profile 9" x 9" and 12" x 12" VGB 2008 compliant suction outlets in the industry

Manufactured from superior UV-resistant engineered polymers

All components (cover, adapter plate, frame, screws) meet or exceed NSF 50/ASME/ANSI A112.19.8a-2008 national standards and ASTM G154 UV testing exposure

Sold with SUN12xxx, not sold separately

12" Square SUN Suction Outlet with 12" Square Double-Deep Sump

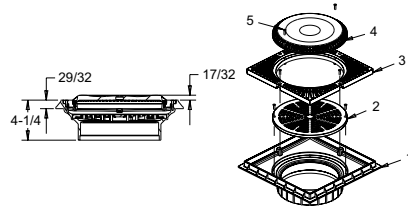

1. 12" square double-deep frame
2. 10" round flat grate (optional)
3. 12" x 12" to 10" round adapter with flow slots
4. 10" anti-entrapment suction outlet cover
5. #10 x 3/4" lg flat head phillips screw, 316 ss, qty 8

Part #
SUN12DDxxx
4 per case

12" Square SUN Suction Outlet with Dual-Port 2 1/2" Spigot x 2" Socket Deep PVC Sump

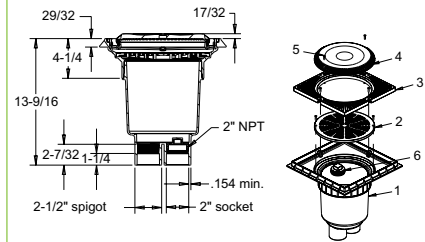

1. Dual-port 2-1/2" spigot x 2" socket deep PVC sump
2. 10" round flat grate (optional)
3. 12" x 12" to 10" round adapter with flow slots
4. 10" anti-entrapment suction outlet cover
5. #10 x 3/4" lg flat head phillips screw, 316 ss, qty 8
6. 2" tapered pipe thread plug

Part #
SUN12DDBSxxx
1 per case

12" Square SUN Suction Outlet with 4" Spigot Deep PVC Sump

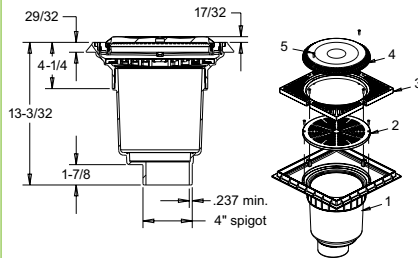

1. 4" spigot deep PVC sump
2. 10" round flat grate (optional)
3. 12" x 12" to 10" round adapter with flow slots
4. 10" anti-entrapment suction outlet cover
5. #10 x 3/4" lg flat head phillips screw, 316 ss, qty 8

Part #
SUN12DDBS4SPxxx
1 per case

12" Square SUN Suction Outlet with 4" Socket Deep PVC Sump

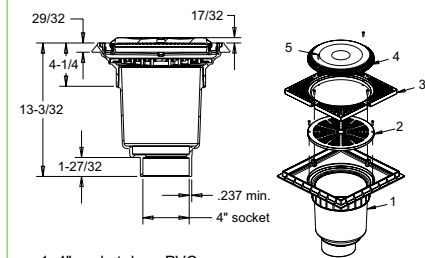

1. 4" socket deep PVC sump
2. 10" round flat grate (optional)
3. 12" x 12" to 10" round adapter with flow slots
4. 10" anti-entrapment suction outlet cover
5. #10 x 3/4" lg flat head phillips screw, 316 ss, qty 8

Part #
SUN12DDBS4SOCxxx
1 per case

12" Square SUN Suction Outlet with 6" Spigot Deep PVC Sump

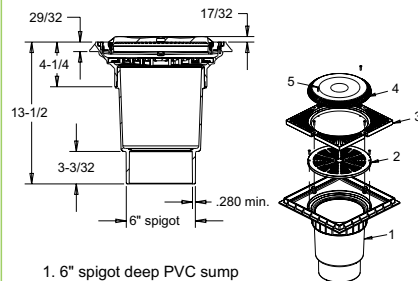

1. 6" spigot deep PVC sump
2. 10" round flat grate (optional)
3. 12" x 12" to 10" round adapter with flow slots
4. 10" anti-entrapment suction outlet cover
5. #10 x 3/4" lg flat head phillips screw, 316 ss, qty 8

Part #
SUN12DDBS6SPxxx
1 per case

12" Square SUN Suction Outlet with 6" Socket Deep PVC Sump

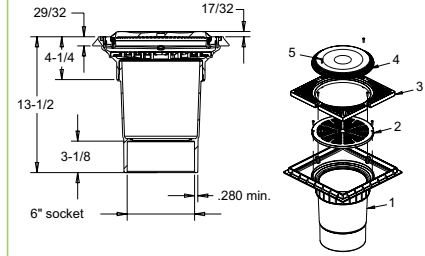

1. 6" socket deep PVC sump
2. 10" round flat grate (optional)
3. 12" x 12" to 10" round adapter with flow slots
4. 10" anti-entrapment suction outlet cover
5. #10 x 3/4" lg flat head phillips screw, 316 ss, qty 8

Part #
SUN12DDBS6SOCxxx
1 per case