

YOU ARE ABOUT TO EXPERIENCE POOLVERGNUEGEN.

(pool-fair-gnyoo-gen)



OWNERS MANUAL ENERGY EFFICIENT RETURN-SIDE PRESSURE POOLCLEANER

● POOLVERGNUEGEN ● 3195 Regional Parkway ● Santa Rosa, CA 95403 ● Tel (707) 566 0400 ●

©2006

THANK YOU FOR PURCHASING *The PoolCleaner*TM

Besides being our company name, "POOLVERGNUEGEN" means pool pleasure. *The PoolCleaner*TM WORKS so that you can experience POOLVERGNUEGEN.

The first thing you will notice when you look at *The PoolCleaner*TM is that it is of highest quality. *The PoolCleaner*TM is robust and if maintained properly will result in many years of pool cleaning. We use only the highest quality materials to ensure the best pool cleaning products. *The PoolCleaner*TM is proudly made in the USA. This cleaner was invented, designed and built with years of experience in the pool industry. Every cleaner is tested to ensure the finest quality.

With the new Pressure *PoolCleaner*TM there is no need for an extra booster pump. This means energy savings. The Pressure *PoolCleaner*TM has an 8" vacuum path. This means more cleaning ability with out clogging.

FEATURES

SELF ADJUSTING TURBINE VANES

All the POOLCLEANERTM cleaners have the patented self-adjusting turbines, which maximize the power from the water flow. This turbine is similar to a paddle wheel with blades that are adjustable. This feature allows the POOLCLEANERTM to still move at low suction and low pressure. In addition the folding vanes of the turbine allow for the easy passage of larger debris through the cleaner.

STEERING SYSTEM

The Pressure POOLCLEANERTM is the only pressure side cleaner with an internal programmed steering system, that causes the left wheel to periodically reverse, allowing the POOLCLEANERTM to turn and then move into another direction. For the Pressure POOLCLEANERTM there are several different programmed turns ranging from 90 to 450 degrees and this allows the Pressure POOLCLEANERTM to travel 12 to 20 ft before it turns. This feature allows the POOLCLEANERTM to cover not only the deep end, but also the shallow end. The POOLCLEANERTM has no problem with uneven surfaces or strange shapes. It won't stick in a corner, or get hung up by a main drain.

ROBUST TIRE TREADS

One look and you will see that the patented tire treads give the POOLCLEANERTM better climbing ability and obstacle maneuverability. The tires come with tread wear markers that show you when to replace your tires. The front tires of the POOLCLEANERTM have humps (raised treads) that allow the POOLCLEANERTM to overcome any reasonable obstacles such as the main drain and uneven surfaces. This makes the POOLCLEANERTM ideal for all pool surfaces and shapes.

EXTRA LARGE DIRT BAG

The Pressure POOLCLEANERTM has the largest dirt bag currently on the market. This bag captures the dirt, leaves and other debris. The bag is easily removed and cleaned. The POOLCLEANERTM patented dirt bag has an internal sock that acts as a trap door by stopping debris from falling back once the Pressure POOLCLEANERTM is shut off.

FAST and EASY SNAP SWIVELS

The unique patented hose swivels allow for fast and easy assembly and installation of your new Pressure POOLCLEANERTM. The swivels snap to connect the 6ft hose sections. They prevent the hose from coiling, and leaking, allowing for the best possible performance from your POOLCLEANERTM.

PRESSURE RELIEF VALVE

The Pressure POOLCLEANERTM comes with a pressure relief valve that regulates the pressure flow to the Pressure POOLCLEANERTM. The relief valve regulates the pressure so as to not exceed the optimal pressure (12-15psi or 11-16 RPM). This will ensure the best possible performance from your Pressure POOLCLEANERTM. It does so by opening to bypass water when necessary. There is NO screen to clean due to the huge venturii jet.





IMPORTANT FACTS

- ✘ The POOLCLEANER™ should **NEVER** be used to remove plaster debris in new “start up” pools.
- ✘ **ALWAYS** remove the POOLCLEANER™ before you chemically shock your pool.
- ✘ **ALWAYS** remove the POOLCLEANER™ when swimmers enter the pool.
- ✘ When removed from the pool store the POOLCLEANER™ in a shaded safe area.
- ✘ When removed from pool **DO NOT** coil the hoses. **THEY MUST BE STORED STRAIGHT**
- ✘ The POOLCLEANER™ is **NOT** a toy and not intended for children.
- ✘ Keep the POOLCLEANER™ and hoses away from chewing pets.
- ✘ **REMOVE** the POOLCLEANER™ when performing backwash.
- ✘ **REMEMBER SAFETY FIRST**

PRESSURE MODEL

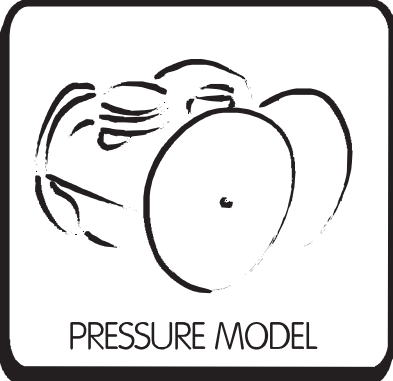
- 1 Pressure POOLCLEANER™
- 1 Pressure Relief Valve
- 1 Wall Fitting Adapter
- 6 Sections Special Pressure Hose
- 5 Easy Snap Swivels
- 6 Floats
- 1 Extra Large Pressure Dirt Bag

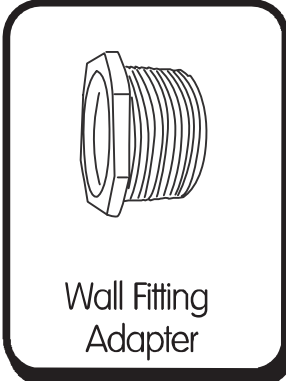
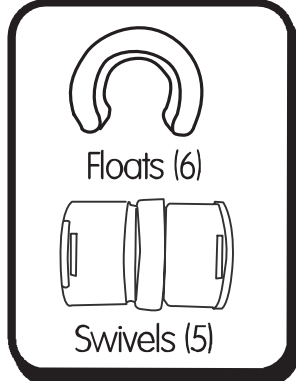
INCLUDED COMPONENTS

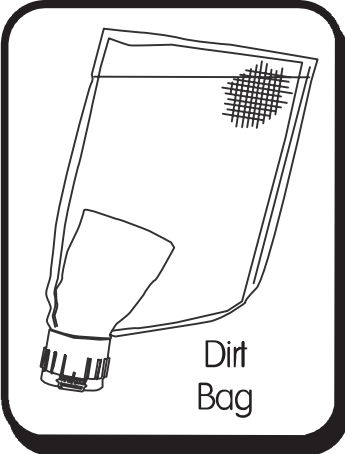
 <p>PRESSURE MODEL</p>	 <p>Pressure Relief Valve</p>	 <p>Wall Fitting Adapter</p>	 <p>Floats (6) Swivels (5)</p>
 <p>Pressure Hoses (6)</p>			 <p>Dirt Bag</p>

INCLUDED WITH YOUR POOLCLEANER

STEP 1 Preparing your pool . . .

1. Manually clean/vacuum your pool.
2. Perform a backwash, clean your filter, skimmer baskets and pump basket.
3. Make sure your chemical balance is correct. If not, now is the time to correct it. If you chemically shock the pool, wait a day or two before continuing.
4. One or more of the return fittings may have to be restricted (read ahead).

STEP 2 Get the hoses ready . . .

1. Take the hoses and lay them out straight for a day in the sun to take out the coil.

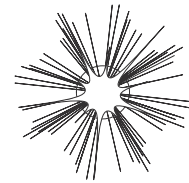

Attaching the extra large dirt bag to the cleaner . . .

2. With the bag opening to the back of the cleaner place the bag so that it is slightly off to the back of the hook on the cleaner (see illustration).

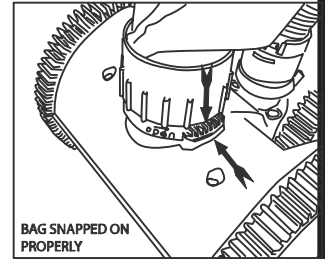
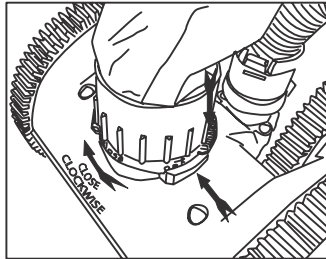

3. Twist clockwise until it snaps.

Connecting the hoses . . .

4. Take one length of hose and attach two of the floats 24" (60cm) from one end. The close end will be where the cleaner is attached, and the end farthest from the floats is where the rest of the hoses will attach.

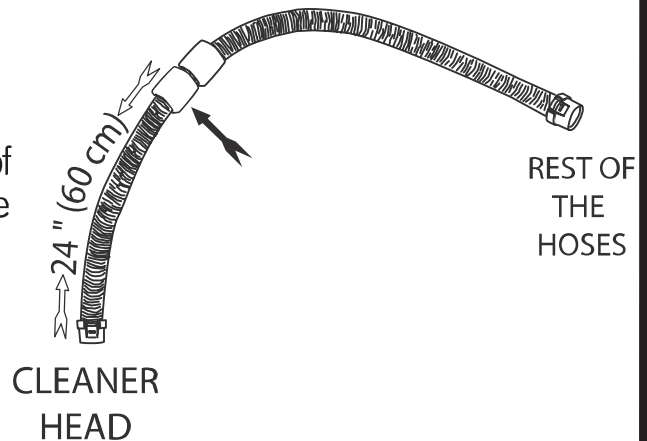

STEP 3 Attaching the PoolCleaner head ...

1. Take the hose section (with the float attached) and pass it through the rope loop (on the bag), and attach the end closest to the float to the cleaner head.

Make sure the tabs and slots are lined up and that both sides "clip" into the slots properly!

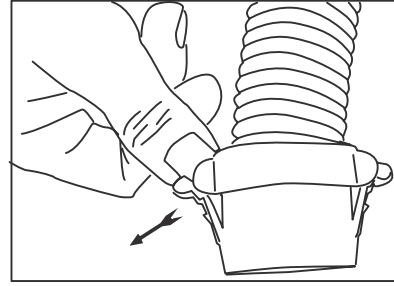

NOTE: It may be necessary to reload the clips on the hoses. Pull the tab on the hose coupling slightly to reload the clipping action.

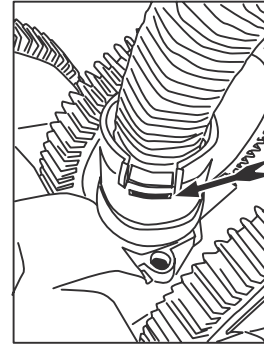
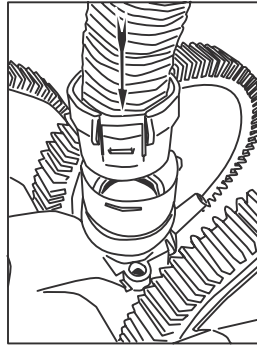
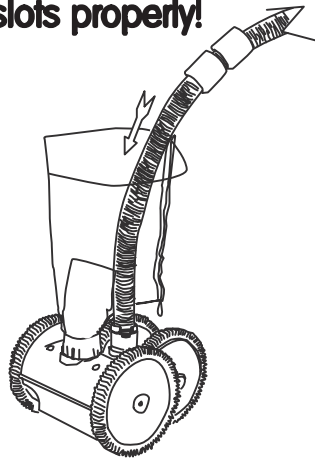

STEP 4 Connecting the hoses ...

1. Connect the remaining 5 hose sections by connecting the hose couplings with the swivels. And attach one end to the hose on the cleaner. If necessary you may have to purchase additional hose sections and swivels (See also "NOTE" on previous step).

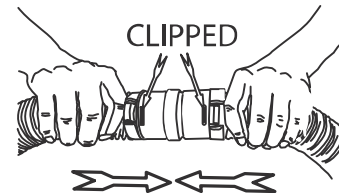
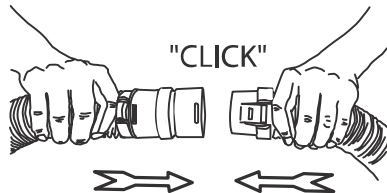
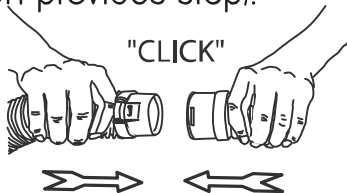

2. Attach a float directly adjacent to each swivel except the one closest to the wall.

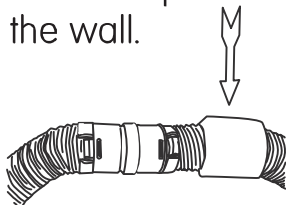

3. The connected hoses should be half to one length longer than the farthest point from the return fitting.

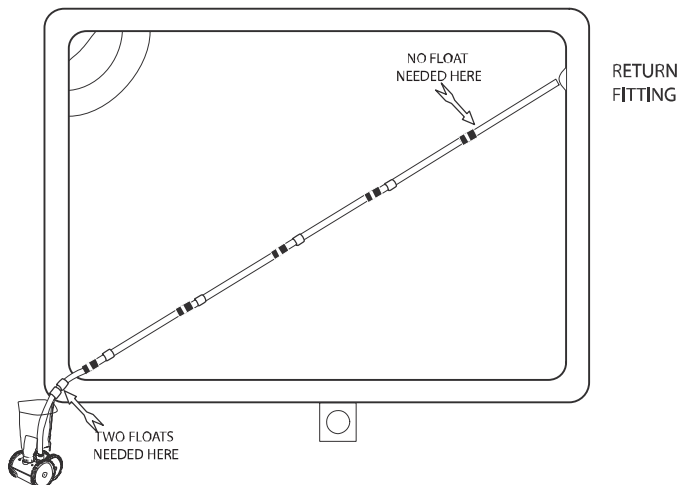

STEP 5 PART I Making the connection...

1. MAKE SURE THE POWER SUPPLY TO YOUR PUMP IS OFF. SUCTION and PRESSURE CAN BE VERY DANGEROUS!!!
2. Remove the return fitting by unscrewing the retaining ring and eyeball. Check to see if you have a 1 1/2" male or female wall fitting (see illustration). If it is a male fitting you will need to purchase a 1 1/2" female threaded coupling as it is not included.

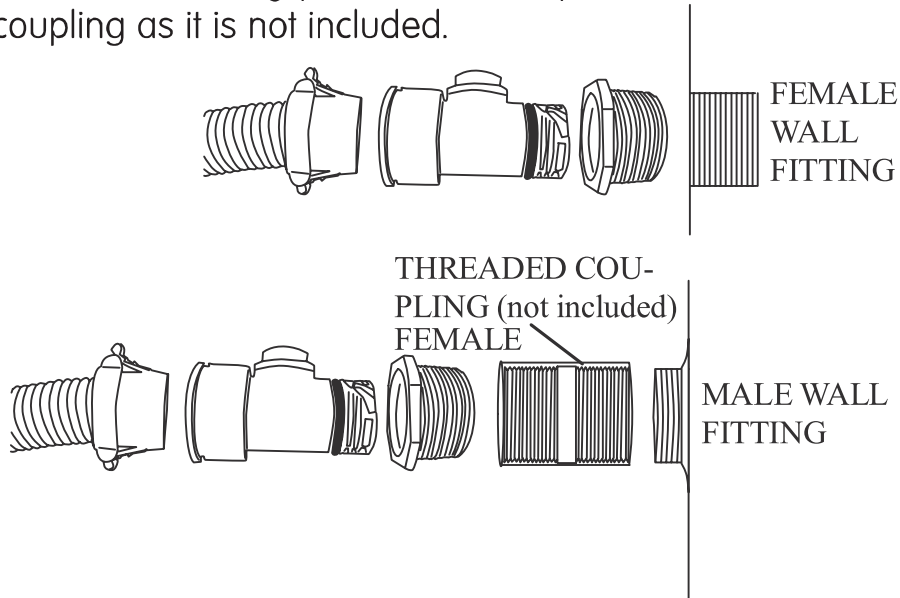

3. Connect the Relief Valve to the hose making sure that it snaps correctly.
4. Screw the Wall Fitting Adaptor into the wall (use a 1 1/2" female coupling if you have a male fitting). Then connect the Relief Valve by pushing on the valve and rotating clockwise until it locks (Bayonet) and then pull on it a little.
5. Switch the pump power back on.

PART II Adjusting the PoolCleaner to optimal FLOW...

6. ADJUSTING WHEEL RPM (Optimal setting 12-15 RPM)
For the PoolCleaner to run optimally the revolutions per minute (RPM) should be between 12 and 15.

While the POOLCLEANER™ is running take it by the hose and hold the PoolCleaner™ just below the water. (KEEP THE CLEANER BELOW THE WATER LEVEL or else it will spray water). Now count the number of revolutions (complete turns) made by the RIGHT FRONT WHEEL per minute by using the hump as your marker. If it is between 12 and 15 RPM you are done with step 5 and your PoolCleaner™ is running optimally.

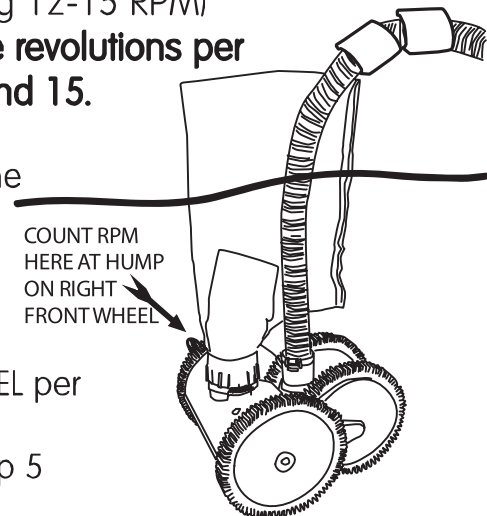

STEP 5 CONT'D...

We at Poolvergnuegen are committed to being an environmentally friendly company.

Here are just a few ways we can help to save energy and resources.

1. The products we make (2 Wheel Suction, 4 Wheel Suction and Return Side PoolCleaner) eliminate the need for a booster pump which can save you the homeowner \$300 or more per year in energy costs, not to mention the cost of the actual booster pump. Our Pressure PoolCleaner runs off of volume not pressure hence no need for a booster pump to increase pressure. Our Return Side PoolCleaner is intended to run off of the return.
2. Many pool owners run the pump much longer than is actually necessary. With a variable or two speed pump you only need to run on high for 2-3 hours. Consult your local energy company or pool professional for more information.
3. Make sure your pump is not overrated. Once you need a new pool pump replace it with a variable speed or 2 speed pump and look at the piping system.
4. Cover pool if heated. Turn off waterfalls and pool lights when not in use.
5. If you have a salt system (salt chlorinator) make sure it is not underrated for your pool. You should NOT have to run the system long hours to get proper chlorination. Keep your chemicals in check. Salt systems still require you to check your chemicals.
6. Clean your filter system and skimmers regularly.
7. If you can not handle your pool get a pool service professional.

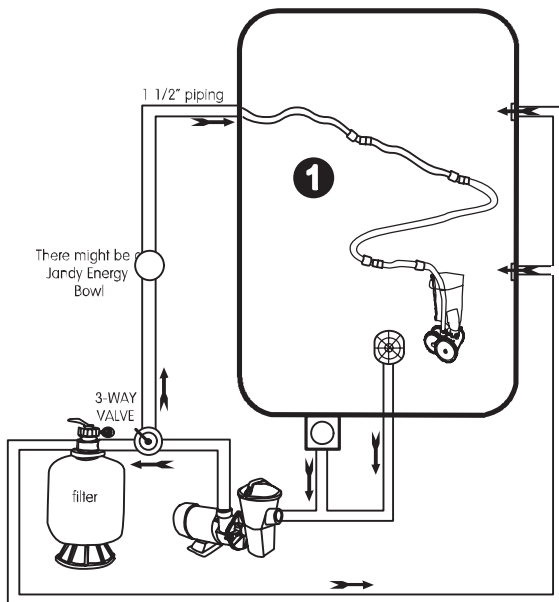

1. The First Plumbing System:

Between Filter and Pump This is when your outlet is plumbed between your pool's filtration system and your pump. Your plumbing has to allow for a min of 25 gal/min (1 1/2" to 2" pipes to and from the pool). NO 3/4" restrictions. Sometimes this is called "Jandy" plumbing & has an Energy Bowl (Jandy).

Above 15 RPM: Adjust your three-way valve away from the PoolCleaner to reduce the flow until the RPM drops below 15 RPM.

Below 12 RPM: Adjust your three-way valve toward the PoolCleaner to increase the flow until the RPM gets into the correct range (12-15RPM).

PLUMB THE RETURN SIDE POOLCLEANER THE SAME WAY YOU WOULD PLUMB AN ENERGY SWEEP.

PLEASE SEE PAGE 8 FOR MORE PLUMBING STYLES...

STEP 5 CONTD...

PLUMB THE RETURN SIDE POOLCLEANER THE SAME WAY YOU WOULD PLUMB ANY OTHER ENERGY SWEEP.

2. The Third Plumbing System: Pump Attached to Filter with 3 Way Valve (No Booster PUMP)

This is the most ideal configuration as it uses the existing system but allows for you to adjust with the 3 way valve.

Above 15 RPM: Adjust your three-way valve away from the PoolCleaner to reduce the flow until the RPM drops below 15 RPM.

Below 12 RPM: Adjust your three-way valve toward the PoolCleaner to increase the flow until the RPM gets into the correct range (12-15RPM).

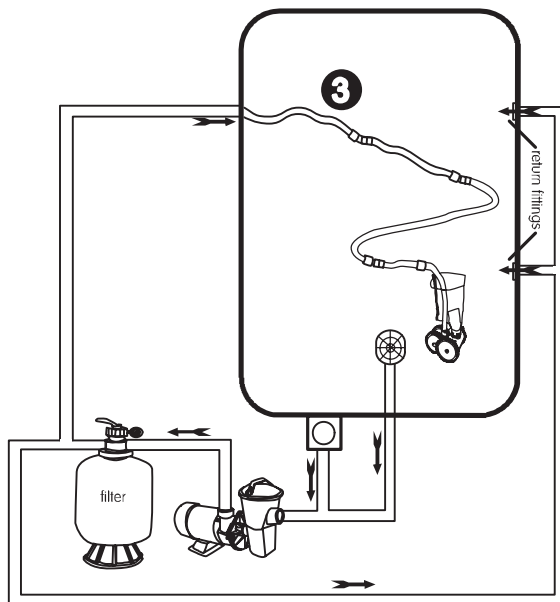
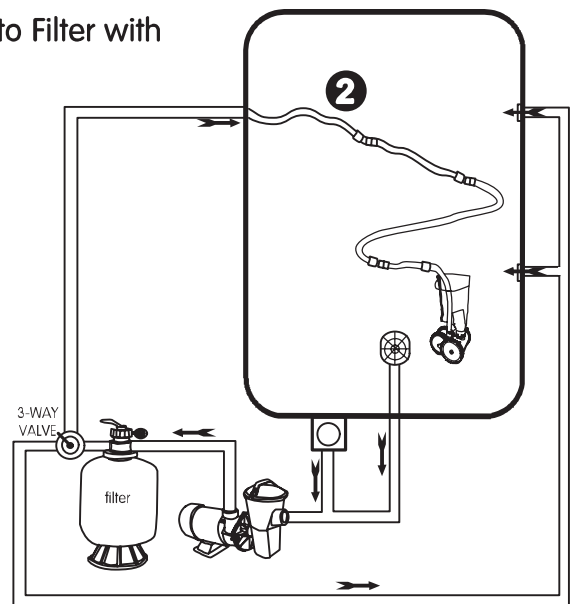

3. The Fourth Plumbing System: Pump Attached to Filter WITHOUT 3 Way Valve (No Booster PUMP)

This is plumbing style may require you to install nozzles in the other returns to restrict or increase the flow of water as there is NO 3 way valve.

Above 15 RPM: Install return nozzles with larger orifice sizes to bypass more of the water flow and reduce flow to the cleaner.

Below 12 RPM: Install nozzles with smaller orifice sizes in the remaining return fittings to increase the flow to the cleaner. (Quick Tip: start with closed orifice and drill a small hole. You can always make bigger holes you can never close a hole.)

SERVICING YOUR POOLCLEANER

(Removal of obstruction or turbine vane replacement)

BEFORE YOU DO ANYTHING, TURN THE PUMP **OFF**. SUCTION & PRESSURE CAN BE DANGEROUS!!!

1 Remove the POOL-CLEANER™ from the pool. Place the hoses straight. Separate the POOL-CLEANER™ from the hose.

4 If need be remove the vanes by sliding them out horizontally. Should there be any obstruction remove it.

When you reinsert the vanes make sure that they fold forward, toward the front of the cleaner (the grill). Also make sure that you don't insert the worn side of the vanes into the turbine hub as this would cause them to fall out.

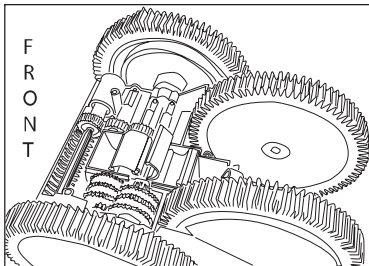

2 First we will check to see if anything is clogged inside the POOL-CLEANER™. Rotate the RIGHT FRONT wheel forward (the grill is the front). If it won't move there is an obstruction. If it moves smoothly there probably is no obstruction.

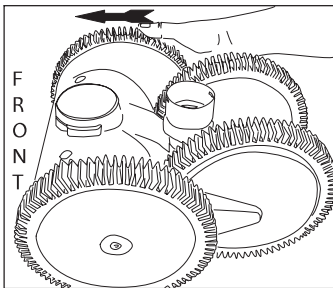

3 Place the cleaner on a work surface. You will need a Phillips screwdriver. Remove the four screws that hold the Shroud (Top Cover). Remove the Shroud. Set the screws and Top aside.

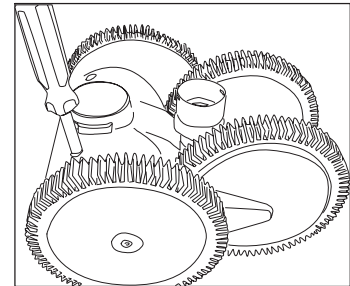

5 Visually inspect the rest of the cleaner, removing any debris that may be in the gears, drive shafts etc. **BEFORE PLACING THE SHROUD BACK ON REPEAT STEP 2 (turn the right wheel) to make sure the POOLCLEANER™ runs smoothly. If it doesn't turn you may have replaced the vanes incorrectly. Make sure the nozzle and partition are in correctly!** Place the Shroud back onto the POOL-CLEANER™ making sure its on correctly. Drop the four screws into the screw holes and secure.

SERVICING YOUR POOLCLEANER

(Changing tires on your PoolCleaner)

BEFORE YOU DO ANYTHING, TURN THE PUMP **OFF**. SUCTION & PRESSURE CAN BE DANGEROUS!!!

1 Remove the POOL-CLEANER™ from the pool. Place the hoses straight. Separate the POOLCLEANER™ from the hose.

2 The tires must be replaced when the tires are worn down to the tread wear indicators!

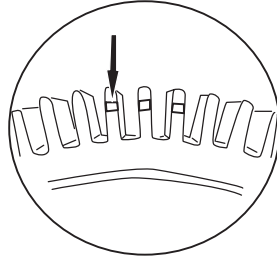

3 Place the cleaner on a work surface. **TO REMOVE THE POOLCLEANER™ FRONT TIRES**, use only your hands (other objects may damage the POOLCLEANER™) simply fold the tire off from top to bottom.

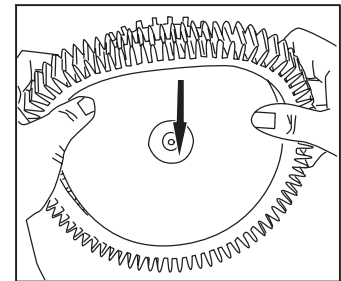

4 **BACK TIRES** remove the Wheel Hubs with a 5/32" or 4mm allen wrench turning the wrench counterclockwise.

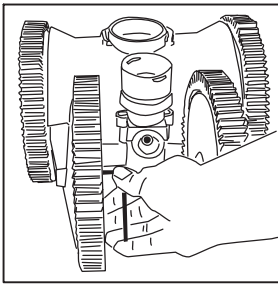

Note: The front tires **ALWAYS** have **HUMPS** (raised treads) The back tires **DO NOT** have humps!

Once off, fold the tire off the Wheel Hub (step 3 above). To replace stretch the tire over the Wheel Hub (starting from one side and folding it back on). Make sure the tire is on correctly.

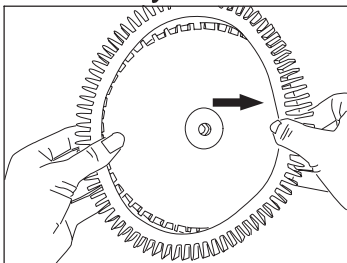

If need be do this closer to your body for better leverage.

5 Place the bolt through the Wheel Hub line it up with the threaded hole, making sure the gear protruding from the POOLCLEANER™ engages with the gears on the Wheel Hub. Tighten bolt with Allen wrench clockwise.

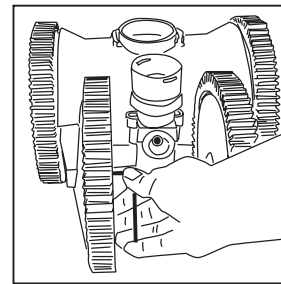
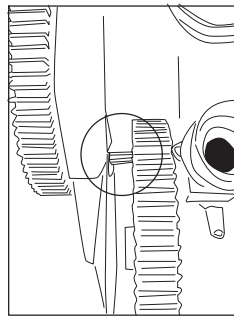

6 Rotate the right front tire forward to ensure that it moves smoothly. If not you fastened the wheel hub incorrectly.

PROBLEM**SOLUTION****The PoolCleaner does not move.**

- ★ The pump may be turned off.
- ★ The pump may not be primed. Check for leaks in the system (symptoms -- bubbles from the returns ?)
- ★ Not enough water flow to the cleaner see pg 7 & 8 on how to increase water flow to the cleaner.
- ★ Problem or obstruction in the system.
- ★ Filter needs backwashing. Clean pump basket. Pump impeller may be blocked (see pump manual)
- ★ Obstruction in the PoolCleaner itself. See pg 9 to clear.

The PoolCleaner moves too slow.
(see also "does not move" above)

- ★ Problem or obstruction in the system.
- ★ Obstruction in the PoolCleaner itself.
- ★ Low wheel RPM (insufficient flow). See pg 7 & 8 to adjust.

The right wheel will not turn when rotated by hand.

- ★ Obstruction in the PoolCleaner itself. See pg 9 to clear.

The loops in the hoses won't come out.

- ★ The hoses have been stored in a coiled position. Lay them straight in the sunlight. Consider buying a PoolCleaner Keeper
- ★ Check each of the swivels for leaks and rotatability.

The PoolCleaner does not clean the entire pool.

- ★ The hose is too short. See pg 5. Step 4
- ★ The float(s) may be in the wrong position. See pg 5. Step 3
- ★ Not enough water flow to the cleaner see pg 7 & 8 on how to increase water flow to the cleaner. If the cleaner is not picking up all the dirt it needs more flow (increase RPM).
- ★ The other return fittings may be pushing the PoolCleaner hoses away. Point them down.
- ★ Make sure the nozzle on the cleaner is pointed to 11 o'clock

The PoolCleaner climbs the wall too much or climbs out.

- ★ The tire treads may be worn down.
- ★ Too much flow. See pg 7 & 8 to adjust.

The PoolCleaner won't climb the wall.
(see also "moves too slow" above)

- ★ Too little WATER flow. See pg 7 & 8 to adjust.
- ★ Float may be in the wrong position. See pg 5. Step 3

The hoses leak.

- ★ The hoses are not properly connected or an animal may have bitten into the hoses.

The PoolCleaner falls on its side and takes too long to recover.

- ★ The float(s) may be in the wrong position. See pg 5. Step 3
- ★ The hose is too short. See pg 5. Step 4
- ★ The return fittings may be pushing the PoolCleaner hoses away. Point them down.

**ALWAYS TURN OFF THE SYSTEM BEFORE PERFORMING ANY REPAIRS. ALWAYS REMOVE THE POOLCLEANER AND TURN OFF SYSTEM BEFORE SWIMMERS ENTER THE POOL .
REMEMBER SAFETY FIRST !!!**

**EXPLODED VIEW of
RETURN-SIDE PRESSURE POOLCLEANER**

PRESSURE POOLCLEANER

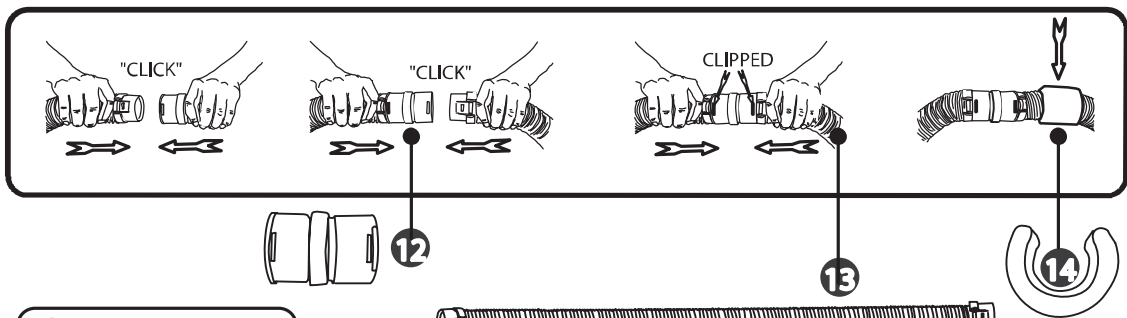
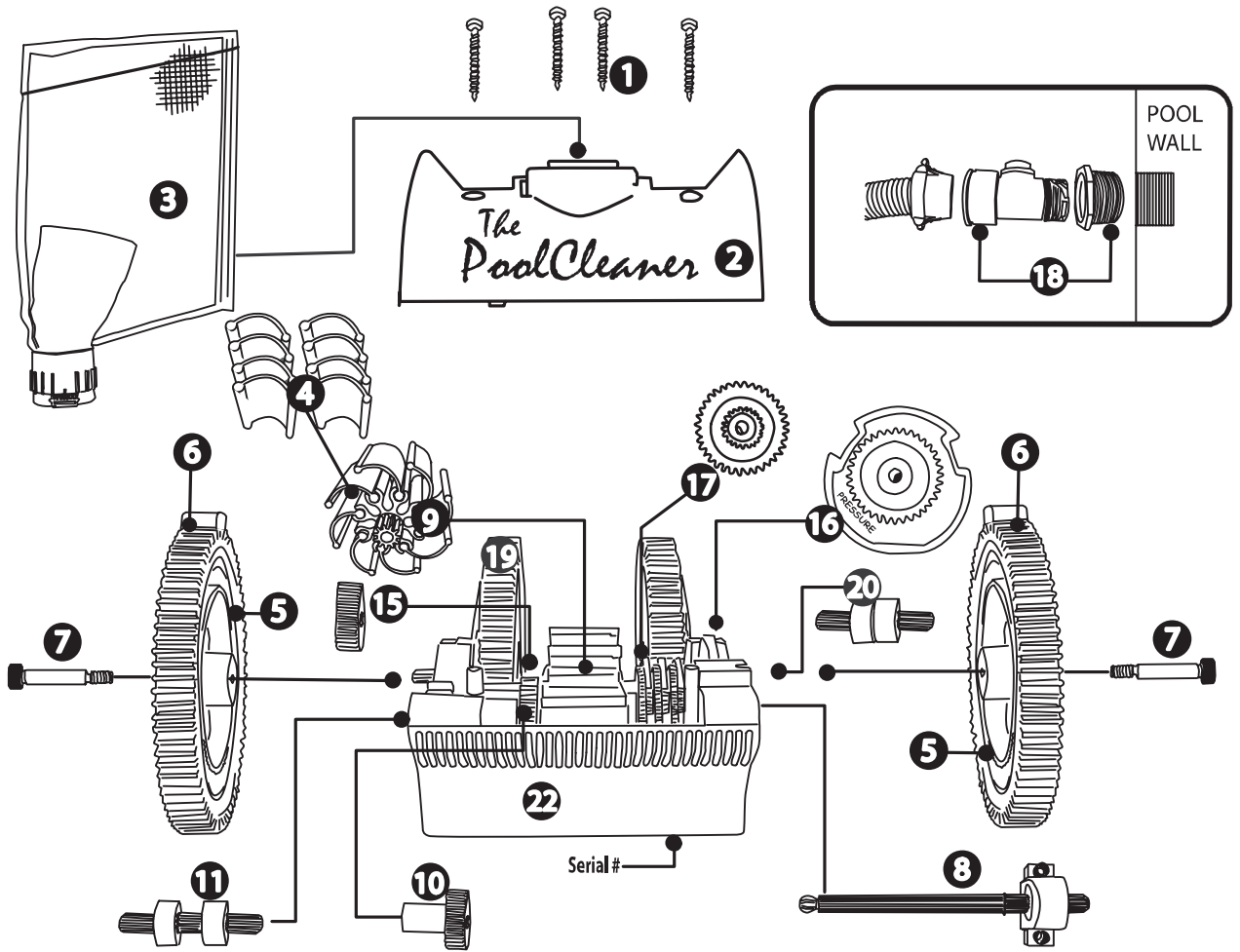

21 Pressure Hose Pack
• 6 EZ Snap
Pressure Hoses
~40 ft total length

EZ Snap Pressure Hose

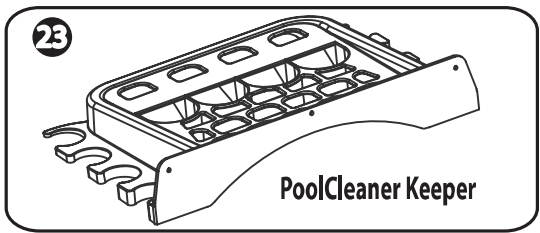

POOLCLEANER PARTS

(AS SEEN IN EXPLODED VIEWS ON PREVIOUS PAGE)

	PART DESCRIPTION	PART #	CLEANER(S)
1.	Pressure Shroud Screws (4 screws per kit)	PN 896584000-303	Pressure Only
2.	Pressure Shroud Kit with Screws (shroud + 4 screws)	PN 896584000-358	Pressure Only
2a.	Pressure Shroud Kit with Screws (shroud + 4 screws) GRAY for LIMITED EDITION	PN 896584000-815	Pressure Only
3.	Pressure Dirt Bag White	PN 896584000-297	Pressure Only
3a.	Pressure Dirt Bag BLACK for LIMITED EDITION	PN 896584000-822	Pressure Only
4.	Pressure Vane Kit (8 vanes per kit)	PN 896584000-440	Pressure Only
5.	Wheel Hub Assemb White	PN 896584000-051	2X and 4X and Pressure
5a.	Wheel Hub Assemb GRAY for LIMITED EDITION	PN 896584000-532	2X and 4X and Pressure
6a.	Solid Front Tires BLUE (2 per kit) for Tile pools	PN 896584000-334	2X and 4X and Pressure
6b.	Solid Front Tires BLACK (2 per kit) for Tile pools	PN 896584000-716	2X and 4X and Pressure
7.	Wheel Bolt Kit (2 per kit)	PN 896584000-198	2X and 4X and Pressure
8.	Steering Slide Assembly	PN 896584000-136	2X and 4X and Pressure
9.	Pressure Turbine Hub and Vane Kit (hub + 8 vanes)	PN 896584000-433	Pressure Only
10.	Large Drive Gear	PN 896584000-457	2X and 4X and Pressure
11.	Front Right Drive Gear Assemb	PN 896584000-112	2X and 4X and Pressure
12.	Pressure Hose Swivel	PN 896584000-273	Pressure Only
12a.	Pressure Hose Swivel BLACK for LIMITED ED.	PN 896584000-846	Pressure Only
13.	EZ Snap Pressure Hose	PN 896584000-327	Pressure Only
13a.	EZ Snap Pressure Hose BLACK for LIMITED ED.	PN 896584000-853	Pressure Only
14.	Hose Float	PN 896584000-280	2X and 4X and Pressure
14a.	Hose Float BLACK for LIMITED EDITION	PN 896584000-631	2X and 4X and Pressure
15.	Small Drive Gear	PN 896584000-464	2X and 4X and Pressure
16.	Pressure Steering Cam	PN 896584000-310	Pressure Only
17.	Reduction Gear	PN 896584000-471	2X and 4X and Pressure
18.	Pressure Relief Valve Kit (wall fitting + valve)	PN 896584000-266	Pressure Only
18a.	Pressure Relief Valve Kit (wall fitting + valve) GRAY	PN 896584000-839	Pressure Only
19a.	Solid Back Tires Blue (2/kit) for Tile pools No Hump	PN 896584000-372	4X and Pressure Only
19b.	Solid Back Tires BLACK (2/kit) for Tile pools No Hump	PN 896584000-761	4X and Pressure Only
20.	Rear Wheel Bearing and Shaft Kit	PN 896584000-129	4X and Pressure Only
21.	Pressure Hose Pack (6 lengths of hose)	PN 896584000-402	Pressure Only
21a.	Pressure Hose Pack (6 lengths of hose) GRAY	PN 896584000-860	Pressure Only
22.	Pressure Lower Body	PN 896584000-709	Pressure Only
22a.	Pressure Lower Body GRAY for LIMITED EDITION	PN 896584000-877	Pressure Only
23.	PoolCleaner Keeper	PN 896584000-501	2X and 4X and Pressure

Replacement parts can be purchased from your pool service or at your local pool store.

Limited Warranty

This limited Warranty is only valid if the Warranty Card has been filled out and returned with proof of purchase within allotted time period. This limited Warranty is extended to the original purchaser (consumer) from the manufacturer of The PoolCleaner™, POOLVERGNUEGEN, 3195 Regional Pkwy, Santa Rosa, CA 95403, USA . Tel (707) 566 0400.

POOLVERGNUEGEN warrants this cleaner to be free from defects in materials and workmanship for a period of one year from the original date of purchase, subject to all the following conditions and exclusions.

1. This limited warranty excludes and does not cover all parts that are subject to normal wear and tear such as, but not limited to any moving parts, tires, skirts, turbine vanes, bypass valve, steering cam, gears, and bearings, bag, which are warranted free from defects when shipped from POOLVERGNUEGEN.
2. This limited warranty is for the replacement of alleged defective parts during the term of the warranty; owner may ship the product by prepaid freight to POOLVERGNUEGEN (3195 Regional Pkwy, Santa Rosa, CA 95403). Enclose a letter including the serial number, date of purchase, name telephone number and address of owner and a description of the problem. POOLVERGNUEGEN, upon determination and at our option, will repair and return to the owner all defective parts that are covered by this warranty. Any parts not covered by this limited warranty will be returned to owner freight collect. All charges or expenses for freight to and from the factory, removal and reinstallation of the product are the responsibility of the owner (purchaser). This limited warranty is for the replacement of defective parts, and does not cover any labor charges, packing, handling or shipping.
3. This Limited Warranty is only extended to the original purchaser (consumer) and only during the time in which the original purchaser occupies the premises where the cleaner was originally installed. It does not apply to any subsequent purchasers or recipients of the cleaner.
4. Certain parts are subject to wear during usage (such as tires, bags, vanes, etc). This limited warranty does not include the replacement of such parts due to normal wear, cosmetic situations including but not limited to: discoloration or fading due to sunlight or chemicals, scratches, scuffs etc.
5. This limited warranty does not cover any loss, damage, injury, or malfunction of the equipment due to the failure to properly maintain and or operate the Cleaner, or alteration of the equipment, tampering, and Act of God, abuse, misuse, negligence, omissions.
6. This cleaner is intended for a properly designed and maintained swimming pool. The limited warranty does not cover pools that have a defective design, are improperly maintained, and are inappropriate for the Cleaner's operation.
7. This limited warranty does not cover damage or injury from improper installation, pump running dry, damage due to loss of prime or plugged pipes.
8. This limited warranty does not cover any change in appearance, damage, malfunction due to chemical reactions.
9. POOLVERGNUEGEN is not responsible for any loss of time, inconvenience or any consequential expenses such as telephone calls, labor etc unless required by law.
10. This limited warranty is only valid in the USA and Canada.
11. This limited warranty is in lieu or any other warranties express or implied, including the warranties of merchantability or fitness. Any such implied warranty imposed by state consumer law is limited in duration to one (1) year from date of purchase.

No distributor, dealer or representative has any authority to make any warranties express or implied concerning The PoolCleaner™ except as contained herein. Unless warranty card has been received by POOLVERGNUEGEN, POOLVERGNUEGEN reserves the right to refuse repair service or to honor warranty.

WARRANTY REGISTRATION CARD

(Include copy of receipt and return within 15 days of purchase)

The additional information requested is to help us understand our customers. The information is NOT sold or shared with any other party.

FIRST

LAST NAME

--	--	--	--	--	--	--	--	--	--	--	--	--	--	--	--	--	--	--	--

--	--	--	--	--	--	--	--	--	--	--	--	--	--	--	--	--	--	--	--

COMPANY NAME (If Pool Service or Builder)

--	--	--	--	--	--	--	--	--	--	--	--	--	--	--	--	--	--	--	--

ADDRESS

--	--	--	--	--	--	--	--	--	--	--	--	--	--	--	--	--	--	--	--

CITY

STATE

ZIP CODE

--	--	--	--	--	--	--	--	--	--	--	--	--	--	--	--	--	--	--	--

--	--

--	--	--	--	--	--

TELEPHONE

FAX

()															
---	--	--	--	---	--	--	--	--	--	--	--	--	--	--	--	--	--	--	--

()															
---	--	--	--	---	--	--	--	--	--	--	--	--	--	--	--	--	--	--	--

EMAIL

--	--	--	--	--	--	--	--	--	--	--	--	--	--	--	--	--	--	--	--

MODEL

SERIAL NO.

- 2 WHEEL SUCTION
- 4 WHEEL SUCTION
- PRESSURE

--	--	--	--	--	--	--	--	--	--	--	--	--	--	--	--	--	--	--	--

(Found under the cleaner)

Are you a:

What Cleaner will this replace? _____

- Consumer
- Pool Service Technician
- Pool Builder
- Other _____

Type of pool:

- Vinyl
- Fiberglass
- Gunitite
- Other _____

Name of Dealer/Builder/Service Prof where purchased

Comments:

Thank you for your purchase.

CUT HERE

WARRANTY REGISTRATION CARD

**DONT FORGET TO INCLUDE A COPY
OF YOUR RECEIPT AS PROOF OF
PURCHASE**

PLEASE MAIL WARRANTY INFORMATION TO:

**POOLVERGNUEGEN
3195 REGIONAL PARKWAY
SANTA ROSA, CA 95403**