

RAYPAK REPLACEMENT INSTRUCTIONS

P.C. BOARD, TEMPERATURE CONTROL & SENSOR (KIT #010253F) FOR ALL DIGITAL GAS POOL HEATERS (SEE "SCOPE" FOR APPLICABLE MODELS)

IMPORTANT NOTICE

These instructions are intended primarily for use by qualified personnel specifically trained and experienced in the installation of this type of heating equipment and related system components. Installation and service personnel may be required to be licensed in some states. Persons not qualified shall not attempt to install this equipment nor attempt repairs according to these instructions.

DANGER - SHOCK HAZARD

Make sure electrical power to the heater is disconnected to avoid potential serious injury or damage to components.

DANGER - PROPANE HAZARD

Make sure to determine if unit is propane and see special instructions on page 6.

SCOPE:

This version of the temperature control board has the capability of an integrated ignition module plus 3-wire temperature sensor. The kit includes a gasket and a plastic shield that is mounted to the back side of the control panel to eliminate moisture accumulation on the LCD display. It is a direct replacement for the following models: 185A, 185B, 206A, 207A, 265A, 265B, 266A, 267A, 335A, 335B, 336A, 337A, 405A, 405B, 406A, 407A.

This kit includes		
(1) P.C. control board	(1) PC board plastic shield	(2) Brackets
(1) Temperature sensor	(6) Plastic #8 washer	(1) LCD Gasket
(1) Remote wire harness	(1) Hi tension wire extension	(4) Screws #6 X 3/8"
(6) Screws #8 X 1/2"	(2) Screws #10 X 1/2"	(1) Instructions

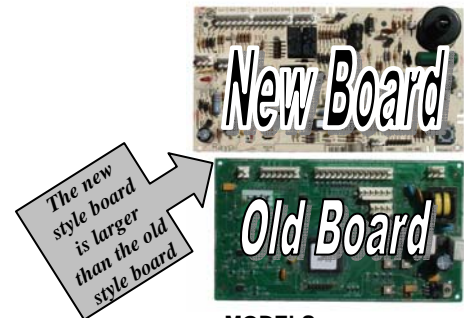

MODELS

185A, 265A, 335A, 405A

PRODUCED NOV. 1998
THROUGH OCT. 2003
SERIAL # 9811 TO # 0310

MODELS

185B, 265B, 335B, 405B

PRODUCED NOV. 2003
THROUGH OCT. 2004
SERIAL # 0310 TO # 0410

MODELS

206A, 207A, 266A, 267A,
336A, 337A, 406A, 407A

PRODUCED OCT. 2004-
THROUGH CURRENT
SERIAL # 0410 - CURRENT



ACCESSING THE BOARD - MODELS

185A/B, 265A/B, 335A/B, 405A/B:

1. Turn off the power to the heater.
2. Turn off the gas to the heater.
3. Remove front door.
4. Remove the four screws on the side of the heater holding the control panel. See **Fig. 1** and **Fig. 2**.
5. Lay control panel forward toward you to access the back of the temperature control board.

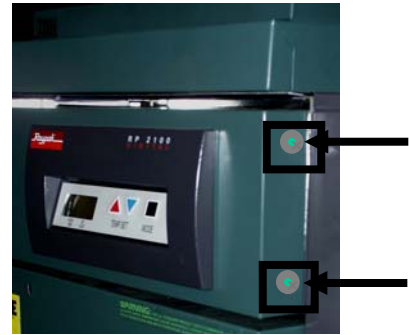

Fig. 1

ACCESSING THE BOARD - MODELS

206A, 207A, 266A, 267A, 336A, 337A, 406A, 407A:

1. Turn off the power to the heater.
2. Turn off the gas to the heater.
3. Remove front door by removing the large door screw shown in **Fig. 3**.
4. Remove the four screws on the side of the control panel. See **Fig. 5** and **Fig. 6**.
5. Lay control panel forward toward you to access the back of the temperature control board.



Fig. 2

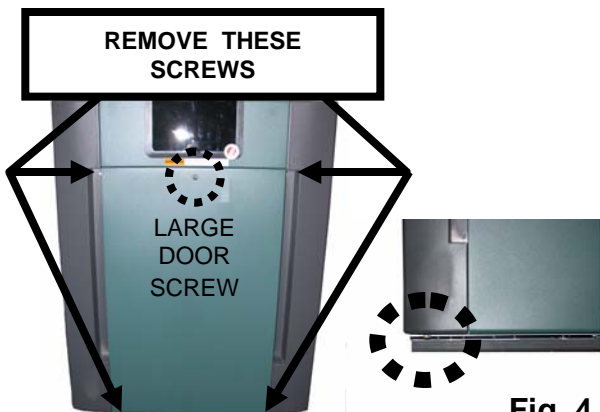

Fig. 3

**Fig. 4
 Close-up**



Fig. 5

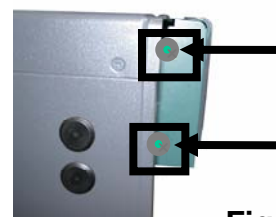

Fig. 6

**REMOVING THE CIRCUIT BOARD - MODELS
185A/B, 265A/B, 335A/B, 405A/B:**

Make sure the power and gas are off.

1. Unplug all connectors from old circuit board. **Fig. 7.**
2. Unplug keypad ribbon from old circuit board.
3. Remove four screws as shown in **Fig. 8.**
4. Remove old circuit board.

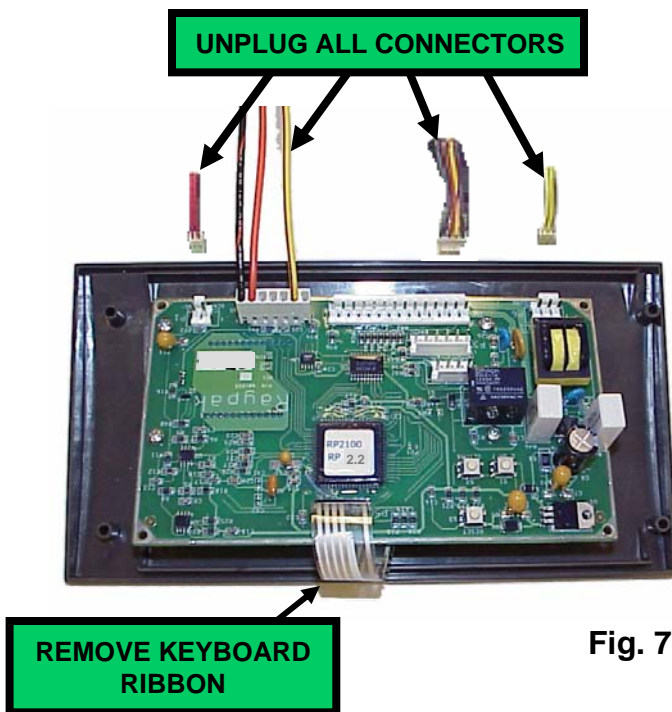

Fig. 7

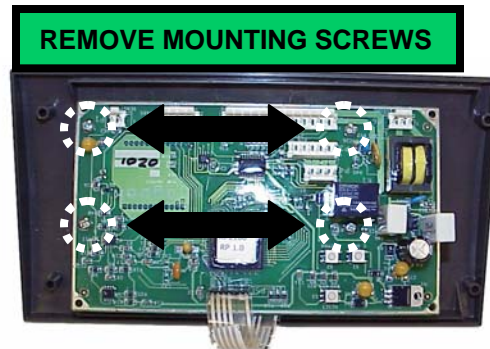

Fig. 8

REMOVING THE CIRCUIT BOARD - MODELS 206A, 207A, 266A, 267A, 336A, 337A, 406A, 407A:

Make sure the power and gas are off.

1. Unplug all connectors from old circuit board. **Fig. 9.**
2. Unplug keypad ribbon from old circuit board.
3. Remove screws as shown in **Fig. 10.**
4. Remove old circuit board.

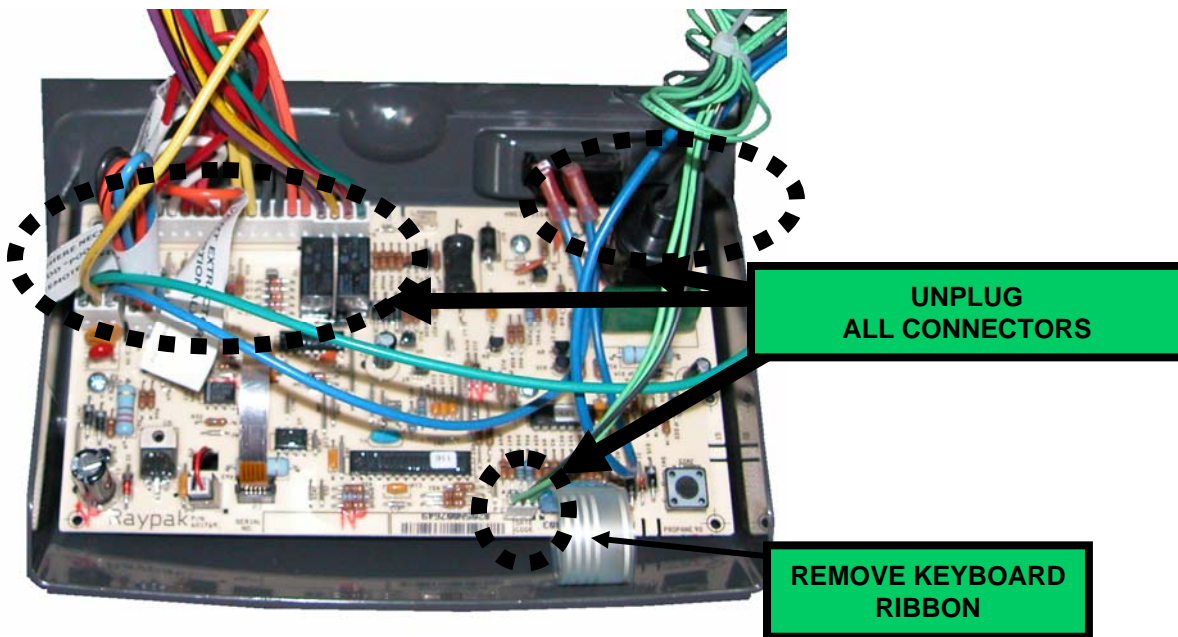

Fig. 9



Fig. 10

DISCONNECTING IGNITION CONTROL - MODELS 185A, 265A, 335A, AND 405A ONLY:

Make sure the power and gas are off.

1. Unplug all wires and connectors from ignition control. (See **Fig. 11.**)

Note: The ignition control is now part of the new control circuit board. Old module can be left in place but **not** used.

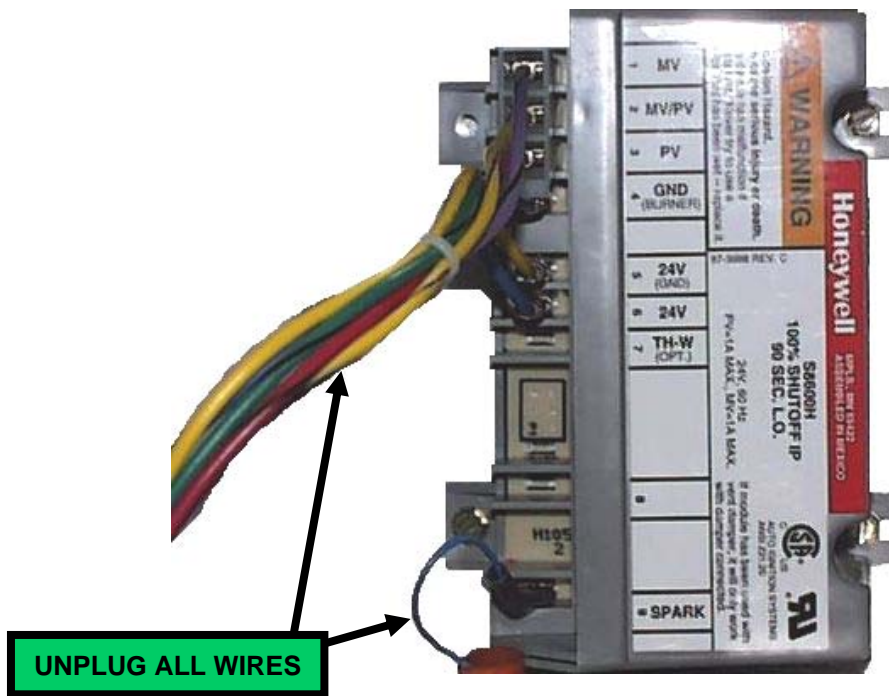

Fig. 11

PROPANE HEATERS ONLY:

Make sure the power and gas are off.

1. Locate the propane tab on the board as shown in **Fig. 12**.
2. Break off tab with pliers as shown in **Fig. 13 & Fig. 14**.

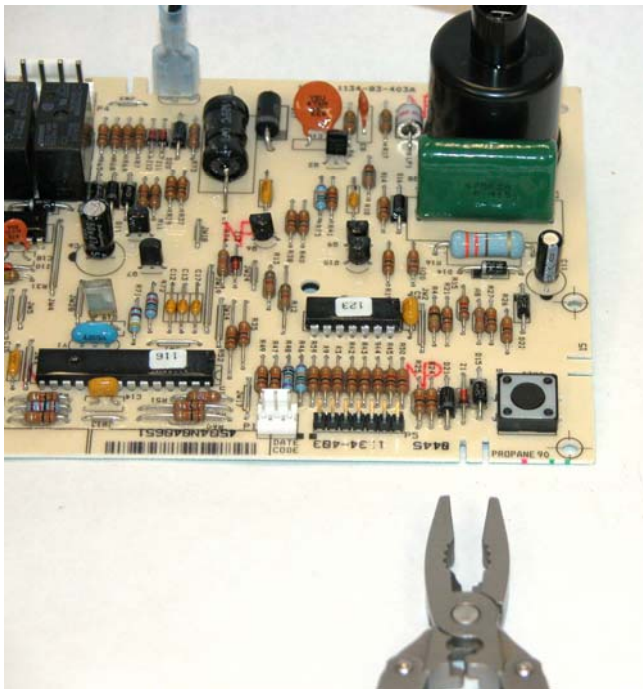

Fig. 12

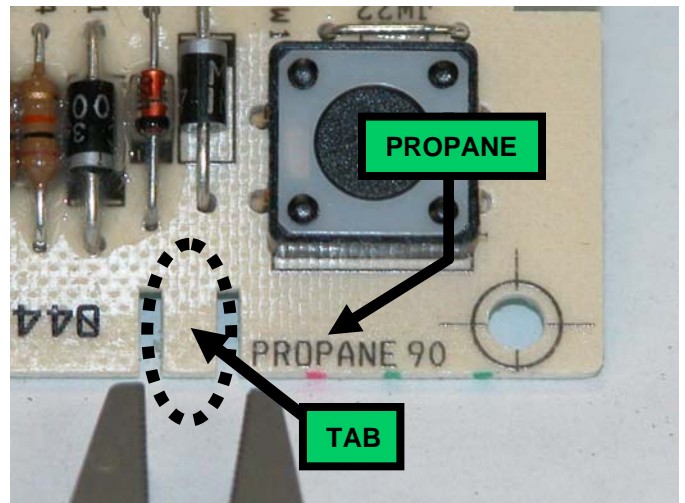

Fig. 13

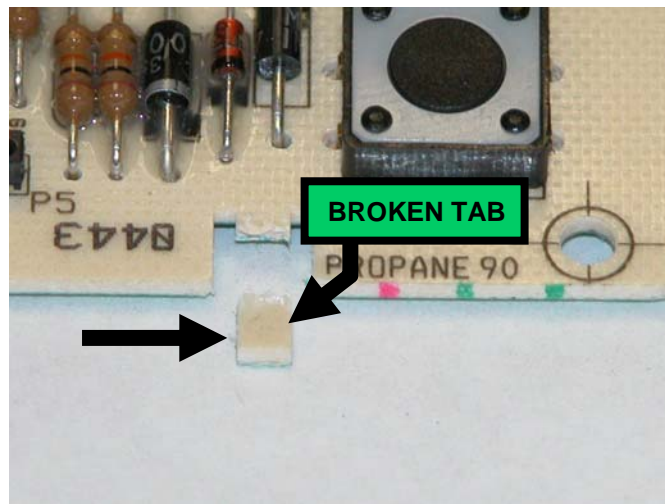

Fig. 14

MODELS 185, 265, 335 & 405, A & B SERIES, LOW NOX ONLY:

Make sure the power and gas are off.

1. **DO NOT** break tab See **Fig. 15** and **Fig.16**.
2. No additional wiring or connections are necessary.

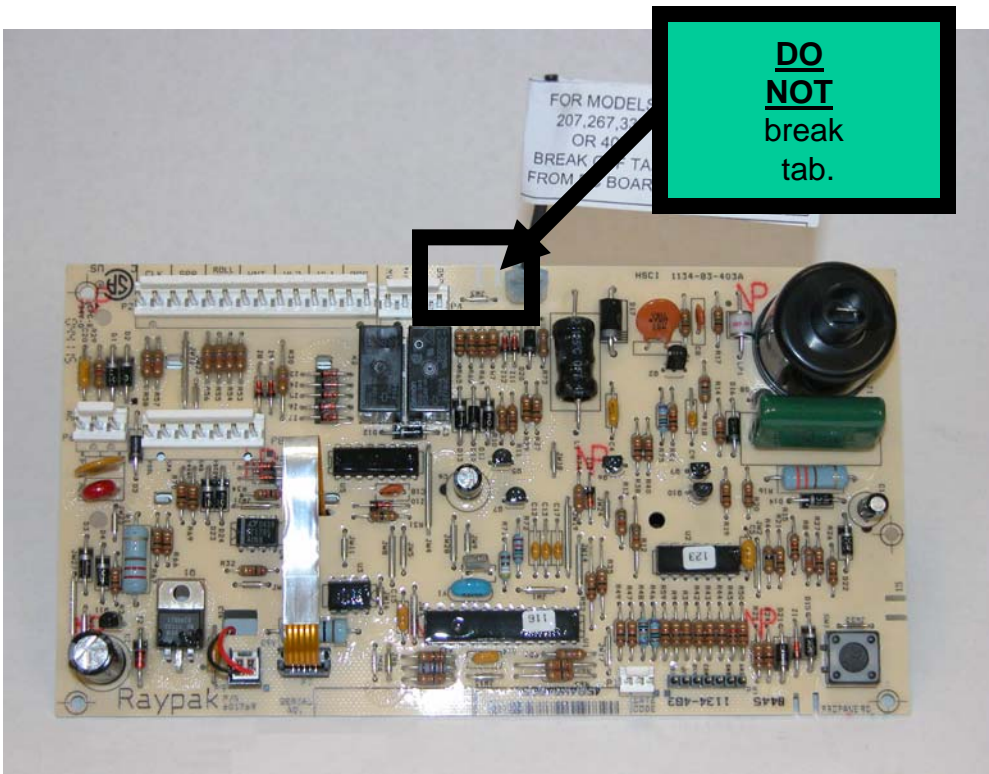

Fig. 15

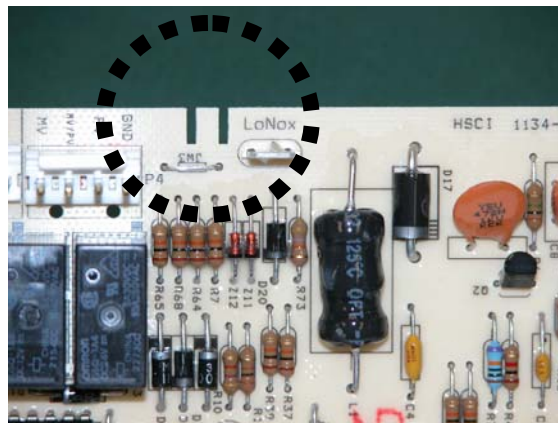

Fig. 16

LOW NOX MODELS 207A, 267A, 337A & 407A:

Make sure the power and gas are off.

1. Locate Lo Nox tab and P-10 air switch terminal on the board as shown in **Fig. 17** and **Fig. 18**.
2. Break off tab shown in **Fig. 19** with pliers.
3. Attach the wire from the air switch to the P-10 location shown in **Fig. 20**.

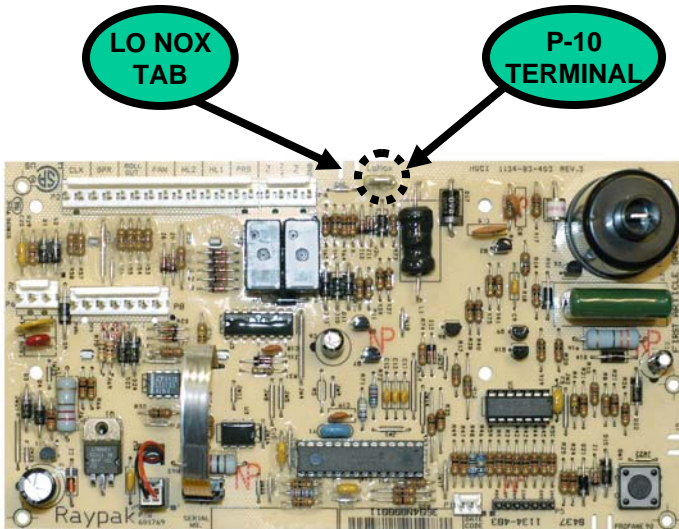

Fig. 17

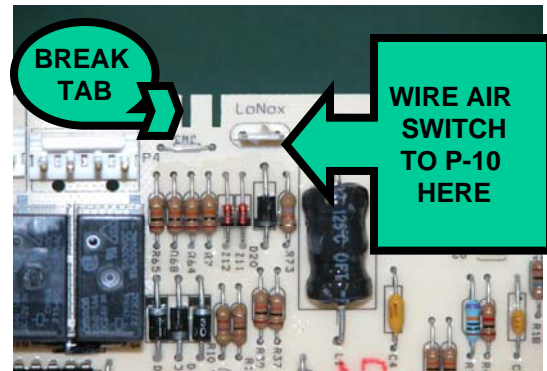

Fig. 18



Fig. 19

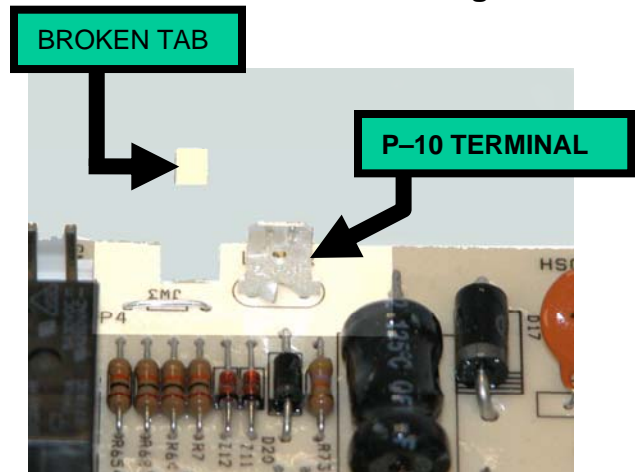

Fig. 20

NEW CIRCUIT BOARD & GASKET INSTALLATION USING OLD BEZEL - MODELS 185, 265, 335 & 405, A & B SERIES:

Make sure the power and gas are off.

Note: Disregard window gasket installation if already present.

1. Remove backing on gasket and install adhesive side on the control panel bezel as shown in **Fig. 21**.
2. Re-assemble with new board to plastic bezel using the three mounting screws as shown in **Fig. 22 & Fig. 23**.

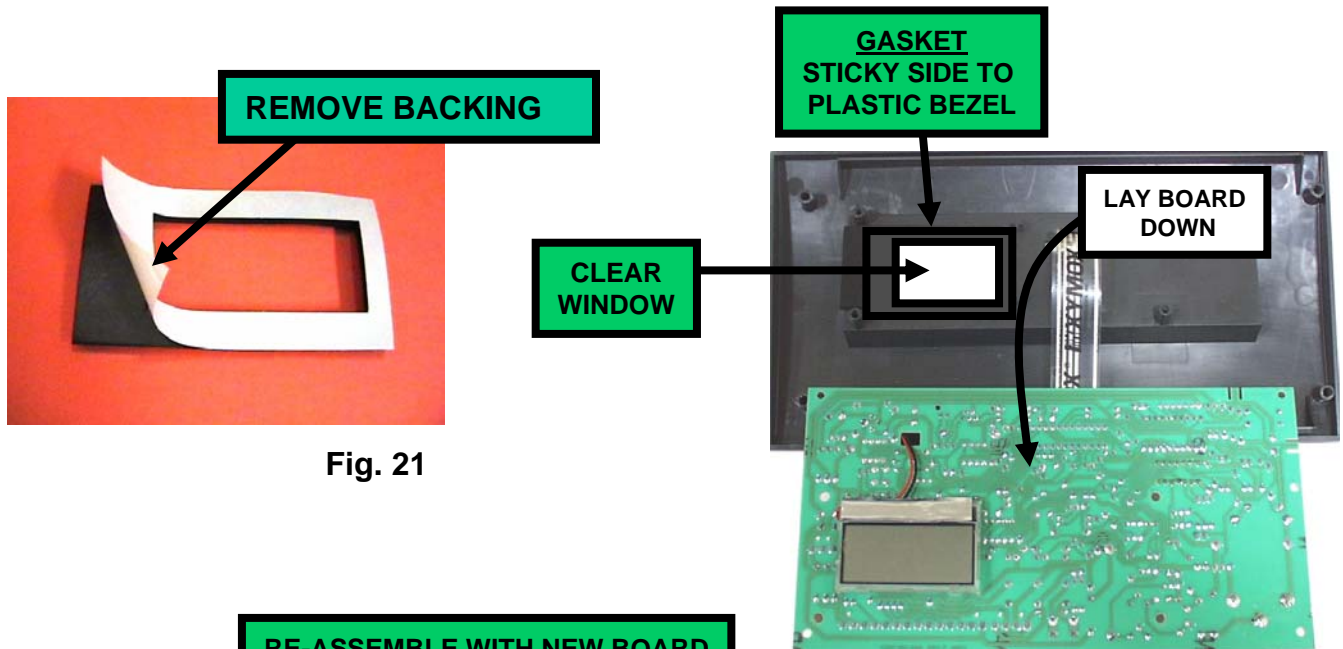

Fig. 21

Fig. 22

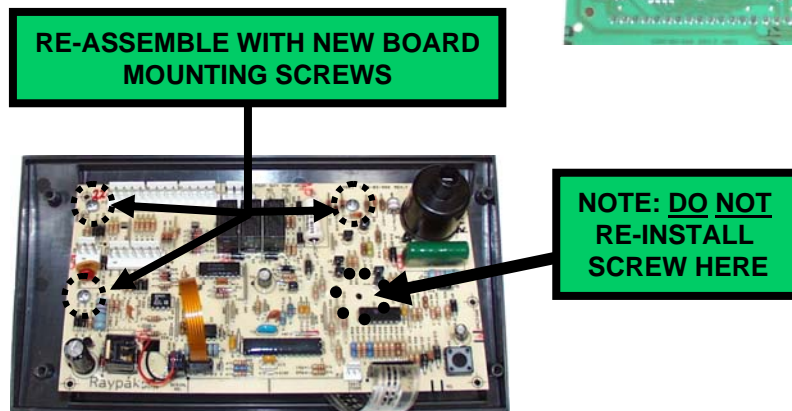

Fig. 23

GASKET & NEW CIRCUIT BOARD NEW BEZEL INSTALLATION - MODELS 206A, 207A, 266A, 267A, 336A, 337A, 406A, 407A:

Make sure the power and gas are off.

Note: Disregard window gasket installation if already present.

1. Remove backing on gasket and install adhesive side on the control panel bezel as shown in **Fig. 24 & Fig. 25**.
2. Re-assemble with new board to plastic bezel using the three mounting screws as shown in **Fig. 26**.

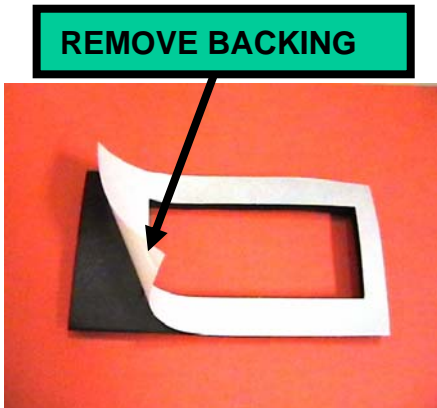

Fig. 24

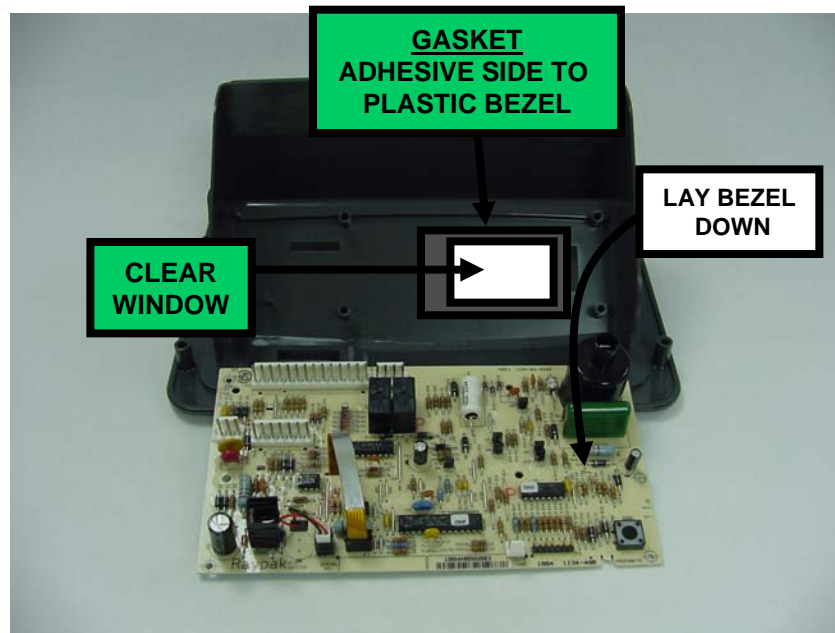

Fig. 25

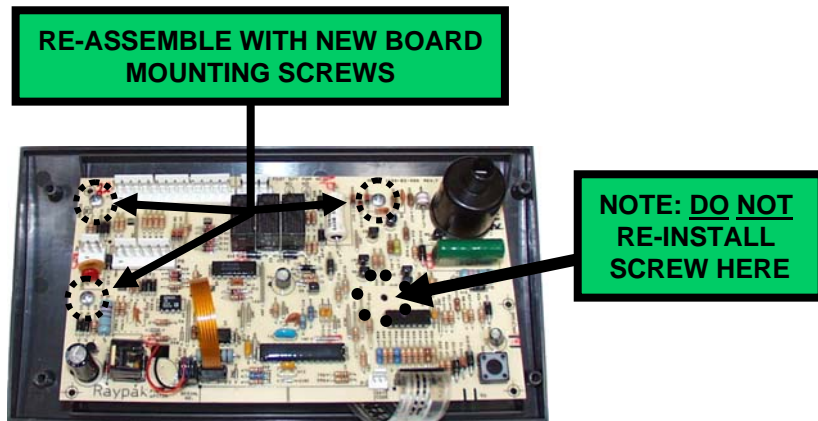

Fig. 26

REMOVING & REPLACING SENSOR - MODELS 185, 265, 335 & 405, A & B SERIES:

Make sure the power and gas are off.

1. Loosen drain plug to relieve pressure in heat exchanger. See **Fig. 27**.
2. Remove five screws and in/out access panel as shown in **Fig. 28**.
3. Re-route the 2-wire sensor connector from the board (P1) back towards the in/out header.
4. Unscrew compression nut and loosen compression fitting to replace old sensor with new sensor. See **Fig. 29**.
5. Install new sensor and tighten compression fitting and compression nut.
6. Re-route the new 3-wire sensor connector back to the board.
7. Plug the 3-wire sensor connector to its correct location, P1, shown in **Fig. 30** and close up in **Fig. 31**.

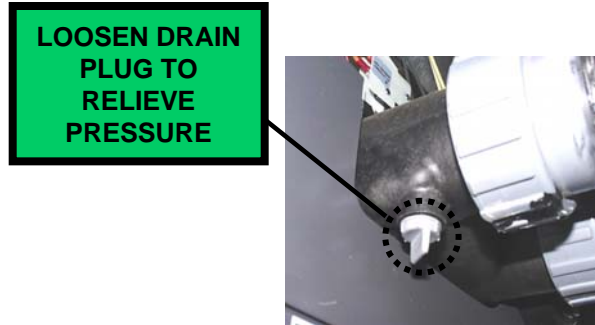

Fig. 27



Fig. 28

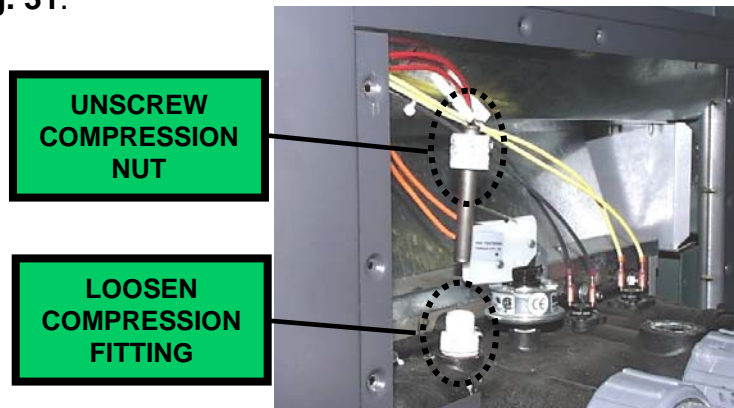

Fig. 29

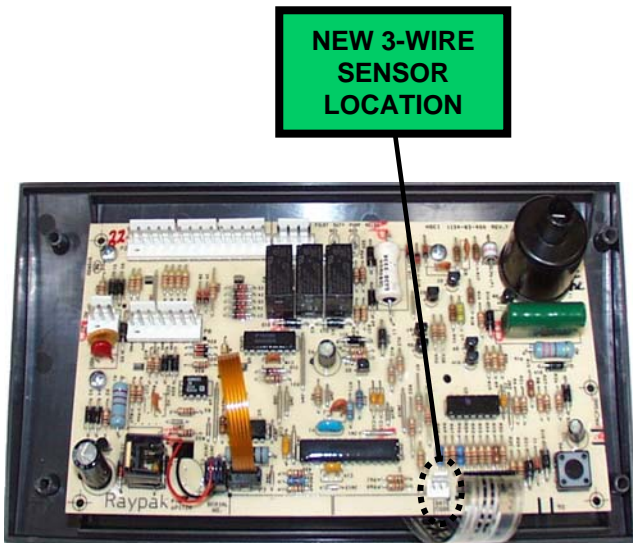

Fig. 30

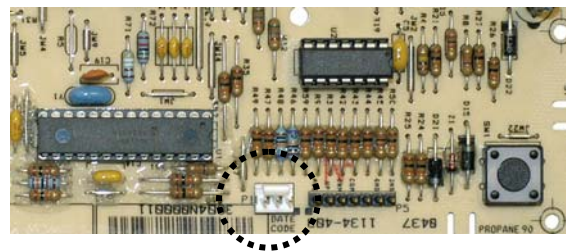

Fig. 31



PLASTIC SHIELD & BRACKET INSTALLATION - MODELS 185, 265, 335 & 405, A & B SERIES:

Make sure the power and gas are off.

1. *Note that the plastic shield is installed under the front bracket as pictured.*
Install the shield brackets and plastic shield using the existing screws on the control panel as shown in **Fig. 32**.
2. Reconnect the wire harnesses to the board.
(Note the location of the clear plastic strip with the thin connector. This is sometimes disconnected when there is a remote control in the system. Refer to the remote wiring instructions for further details.)
Note: Make sure 3-wire sensor plug is connected.

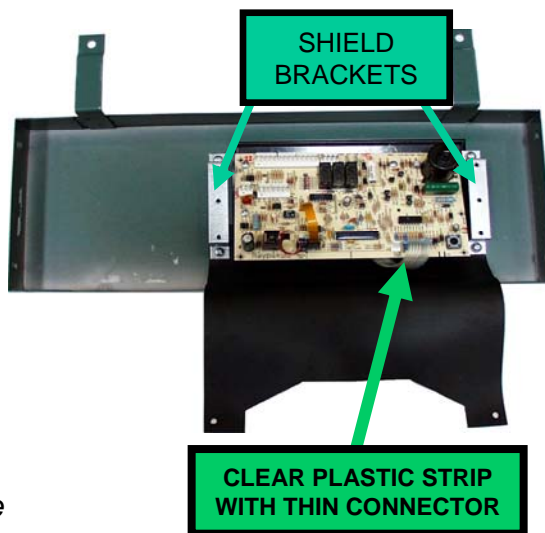

Fig. 32

3. Install the plastic shield over the board and attach to the brackets using the screws and washers provided in the kit. See **Fig. 33** and **Fig. 34**.
4. Re-install the sheet metal panel holding the board back into the heater.
5. Go to remote operation instructions.

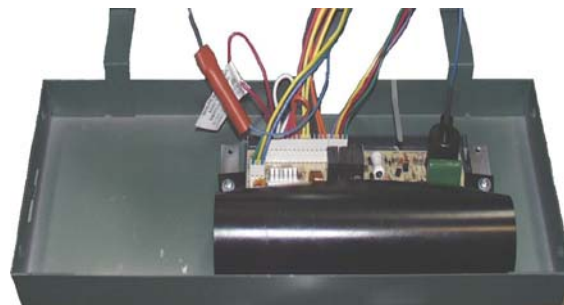

Fig. 33

OR

Return the control panel to the upright position and re-attach using the screws previously removed.

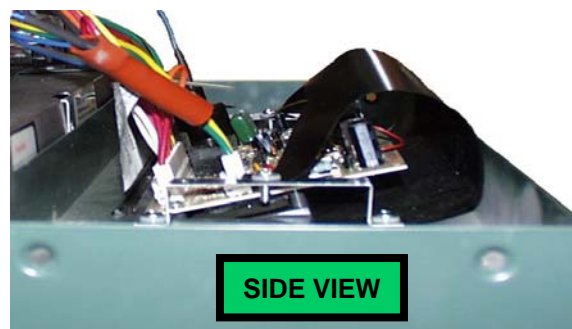

Fig. 34



INSTALLING PILOT HI TENSION: 206 TO 267A:

Ensure the power and the gas has been shut off.

1. Re-connect pilot wire (side B) to new board. See Fig. 35.

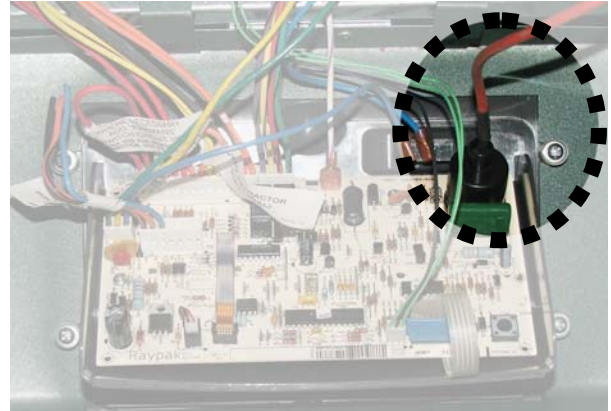

Fig. 35

INSTALLING PILOT HI TENSION WIRE EXTENSION SIZES 335A TO 407A:

Ensure the power and the gas has been shut off.

1. Re-connect pilot wire (side B) to new board with new extension Fig. 36 & Fig. 37.
2. Connect side 'A' to existing pilot wire and center protective sleeve over connection.

CONNECT THIS END TO EXISTING PILOT WIRE

CONNECT THIS END TO NEW PC BOARD SPARK LUG

EXISTING PILOT WIRE

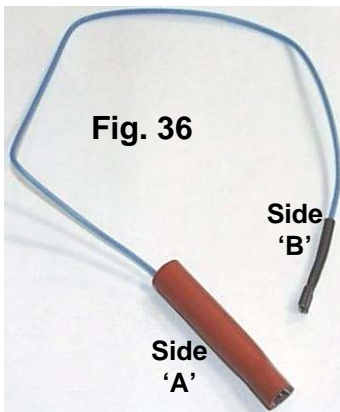
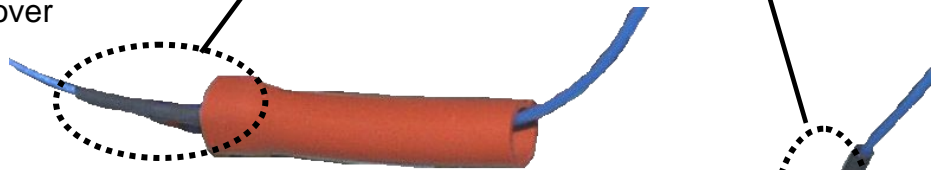
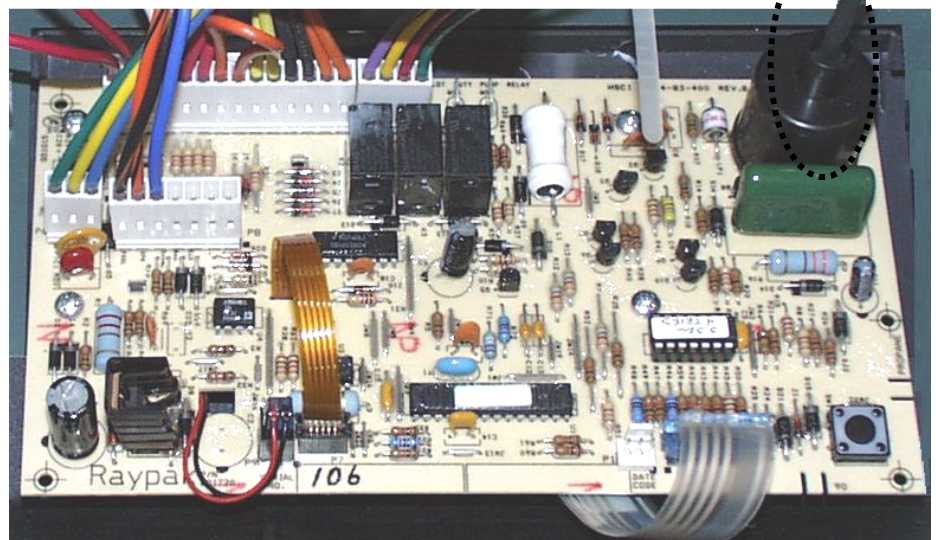

Fig. 36

Fig. 37





DIGITAL THERMOSTAT CONTROLS

Thermostat operation

Your heater is equipped with a microprocessor-controlled thermostat that controls the pool or spa temperature by measuring the temperature of the water coming back through the heater. It will then monitor the water temperature and turn the heater back on when it senses that the water temperature is falling below the set point. It is normal to experience small fluctuations in the return water temperature during the operation of the heater. The thermostat is calibrated with a very narrow tolerance to ensure accuracy of the set temperature. Thus, **slight fluctuations in water temperature may cause your heater to cycle on and off frequently. This is not a problem.** It will not harm the heater nor interfere with the thermostat’s ability to precisely control the temperature of the pool or spa.

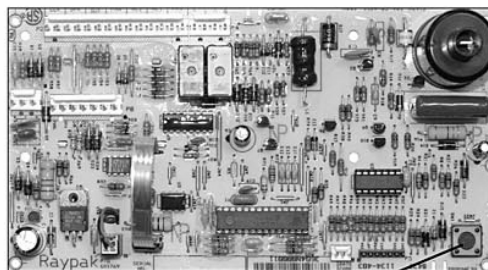
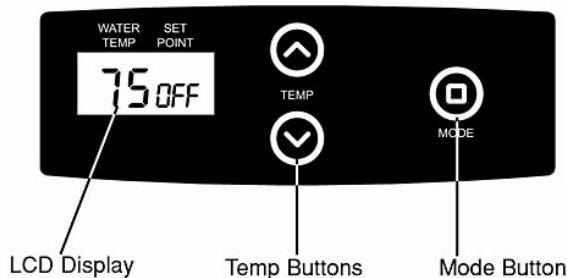

THERMOSTAT CONTROL OPERATION

The pool heater thermostat, located on the upper front panel of the heater, controls the pool/spa water temperature. This control center contains a mode button, up and down temperature adjustment buttons, and an LCD display.

Mode Button

The MODE button functions as a means to turn the heater off or on in either the POOL or SPA setting. The LCD display indicates the mode the heater is in and the actual water temperature.

Temp Buttons

If the heater is in POOL or SPA mode, the desired water temperature (SETPOINT) will also be displayed and may be changed using the UP or DOWN buttons. A manual toggle switch is also provided right below the MODE button to allow the heater to be turned off.

Operation

In the POOL or SPA modes, the actual water temperature is displayed along with the desired water temperature (SETPOINT). If the heater is firing, a flame icon will be visible.

To adjust the setpoint temperature, make sure the control is in the appropriate mode (POOL or SPA) and push the UP or DOWN buttons.

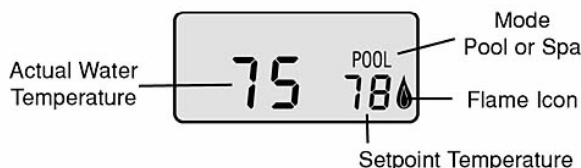

DISPLAY CALL FOR HEAT

Fault History File

To access the Fault History File, press the **Mode** button until the display reads **OFF**. Press both the “UP” and “DOWN” buttons at the same time (5-7 seconds) until the display changes and shows a fault code. The latest fault code will be displayed first. By pressing the “UP” or “DOWN” buttons, a series of faults will be displayed from the last (highest number) to the first (lowest number). If the buttons are not touched after 5-7 seconds, the display will return to its normal operation.





Program Button

- 1) To access the program screen, press the Mode button until the display reads **OFF**. Remove the four screws holding the control cover on. Swing control panel down so the back side of the board is visible (see page 30). Locate the Program Mode button as shown in the figure on pg. 32. Press the program button (5-7 seconds) until **SETdef** appears on the digital display. Release the program button.
- 2) Press the **Mode** button sequentially until the desired program event is reached. There are 5 different events that can be programmed. They appear in the sequence listed below:



Resets board to factory default settings.



Resets faults in the History File.



Change from Fahrenheit to Celsius.



SPA setpoint maximum adjustment.



POOL setpoint maximum adjustment.

SETdef – Default Settings

Refer to step one above to access the program screen. **SETdef** should appear on the screen. If not, press the **Mode** button until **SETdef** appears on the digital display. Press and hold both “UP” and “DOWN” buttons for 5-7 seconds until 3 dashes (---) appear. This operation resets the operating program to its factory default values. Both the POOL and SPA setpoints will revert to 65°F (18.5°C) and both POOL and SPA maximum temperature settings will be 104°F (40.0°C). Once this is done, reassemble the control panel.

RESfl – Reset Fault History

Refer to step one above to access the program screen. Press the **Mode** button until **RESfl** appears on the digital display. Press and hold both “UP” and “DOWN” buttons for 5-7 seconds until 2 dashes (--) appear. This operation resets the Fault History file to “0” and clears all the stored faults. Once this is done, reassemble the control panel.

F/Cff – Fahrenheit to Celsius

Refer to step one above to access the program screen. Press the **Mode** button until **F/Cff** appears on the digital display. The digital display is capable of displaying Celsius as well as Fahrenheit temperatures. The “UP” or “DOWN” buttons will select “F” or “C” on the temperature display. Choose the desired temperature scale. Once this is done, reassemble the control panel.

SETspa 104 – SPA Set Point Maximum Adjustment

Refer to step one above to access the program screen. Press the **Mode** button until **SETspa 104** appears on the digital display. Using the “UP” and “DOWN” buttons will change the Maximum Temperature Setting to your desired value. The control can be set for a maximum of 107°F. Once this is done, reassemble the control panel.

SETpool 104 – POOL Set Point Maximum Adjustment

Refer to step one above access into the program screen. Press the **Mode** button until **SETpool 104** appears on the digital display. Using the “UP” and “DOWN” buttons will change the Maximum Temperature Setting to your desired value. The control can be set for a maximum of 107°F. Once this is done, reassemble the control panel.





NOTE: The LCD temperature display may not agree with the temperature reading of your pool or spa thermometer. The heater reads the water temperature at the inlet. Due to the circulation characteristics of any pool or spa, the water temperature at the inlet to the heater may differ from that observed at a given location in the pool or spa.

DIAGNOSTICS

The digital thermostat models are equipped with on-board diagnostic controls. If there is a safety fault, a fault code will be displayed along with a service indication.

If the PRS fault code is displayed, it indicates that there is insufficient water flow through the heater. Make sure the pool filter and pump strainer are clean before calling a service representative.



READING A FAULT

The word "SERVICE" will flash on and off if the PC board detects a known fault. The fault will be displayed in three big letters on the lower left of the display.

3 Letter Fault Code
See table for fault definition



STATUS CODES

Display	Definition
CFH	Call for heat
CLK	Time clock
EOL	End of line test (Factory Use Only)
LON	Low NOx Unit
LOW	Caution-low water temperature
OFF	Off mode
PRO	Propane gas configured
REM	Remote control activated
SPK	Spark
SPR	Spare fault code indicator

PROGRAM MODES

Display	Definition
CCC	Celsius setting
F/C	Change from Fahrenheit to Celsius
FFF	Fahrenheit setting
RES	Reset defaults
SET	Set point max adjustment

FAULT CODES

Display	Definition
BD1	Board failure
EEP	Microprocessor error
FAN	Blower pressure failure
FFL	Flame sensing when pilot and gas valves are closed
GVC	Gas valve closed
GVO	Gas valve open
HL1	High limit switch #1 open
HL2	High limit switch #2 open
IGN	Ignition failure
ILO	Ignition lockout
PLT	Pilot failure
PRS	Water pressure switch open
ROL	Heat roll-out safety switch open
SNS	Sensor failure
VNT	Vent switch open





REMOTE CONTROL INSTALLATION AND OPERATION

CAUTION: Before installing remote controls to the digital thermostat model heaters read the following: The digital thermostat model is remote-ready in most cases. The digital liquid crystal display (LCD) shows the actual pool temperature, operating status, and service codes (See examples below). The touch pad on the control panel allows you to select the desired pool or spa temperature. It also indicates when a remote system is controlling the heater by displaying REM in the display. When connecting the heater to a remote system, identify whether it is a two- or three-wire remote system. Select the appropriate instruction listed below to properly install the remote to the heater.

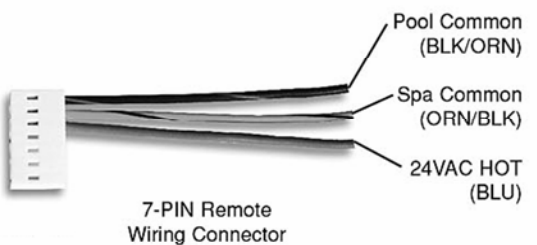
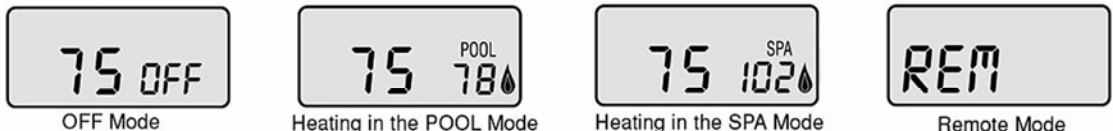

ACTIVATING THE REMOTE

The digital thermostat heaters have the ability to disconnect from the remote it is wired to. To activate or deactivate the remote follow these steps:

Press and hold all three buttons for 5 to 7 seconds.

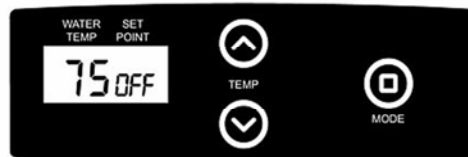

The digital display format will change and indicate REMoFF or REMOn.

REMOTE OPERATION

The digital model heaters are equipped with the ability to work with external remote controls. The supplied 7-pin remote wiring connector supplies power out to either a toggle switch or the switch contacts of a third party remote. The remote works by either making or breaking the circuit created by the remote wiring. Typically, a remote does not supply power to the heater, it only provides a switching function to turn the heater On or Off. **If your remote is supplying its own voltage to the heater, it will not work with this heater and may damage the digital circuit board.**



REMOn = External remote control active (display will flash REM)



REMoff = Remote disabled (heater thermostat will control heater - use this mode to test heater operation)

NOTE: When in remote operation, the keypad mode and temp buttons are disabled. Remote will flash even when the unit is off.

ATTENTION
OBSERVE PRECAUTIONS
ELECTROSTATIC
SENSITIVE DEVICES

Note: Electrostatic Discharge (ESD) damage can be caused by direct or indirect contact with the wiring or circuit board. When one walks to the heater area, an electrostatic charge accumulates on the body. Contact of a finger allows the body to discharge, possibly causing device damage. This damage can be limited if the service person discharges himself, following ESD preventive/removal practices, and holds on to the heater enclosure for 5 seconds before proceeding.



REMOTE CONTROL WIRING

Important Installation Notes for Remote or External Wiring Configuration

- Remote wiring must be run in a separate conduit.
- Remote wiring must not be run parallel to high voltage lines.
- For runs of under 30 feet, remote wiring should have stranded conductors with a minimum of 22 AWG, 600V, cable twisting 1.5 to 2.5 in. lay and jacketed.
- For runs over 30 feet, the conductors should be a minimum of 20 AWG, 600V, cable twisting 1.5 to 2.5 inch lay that is shielded and jacketed.
- Maximum cable length is 200 feet.
- For both two- and three-wire remote systems, the provided 7-pin wiring connector must be utilized. Please refer to the wiring instructions.

Note: The remote wires must be connected to the 7-pin connector before the connector is plugged into the board.

2-Wire Remote Control (On-Off)

This application assumes that only one heating function (pool or spa) is required.

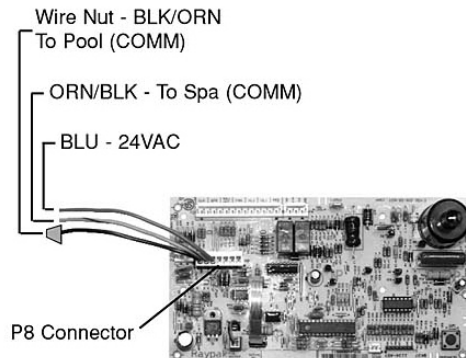

1. Turn on power to the heater.
2. For a 2-Wire Remote Control from a remote without its own sensor, push the mode button to the "POOL" or "SPA" mode and set the desired setpoint (eg. 102 °F for spa).
3. For a 2-Wire Remote Control from a remote with its own sensor, push the mode button "POOL" or "SPA" mode and set the temperature to the highest setting available on the control. The actual setpoint will be controlled by the remote control.
4. Turn the mode button to "OFF" and remove power from the heater.
5. On the "Remote Interface Harness", connect the BLUE wire to one side of the "REMOTE" switch and connect the other side to either the ORANGE/BLACK wire for "SPA" operation or the BLACK/ORANGE wire for "POOL" operation.
6. Attach wire nut on unused wire to the "Remote Interface Harness."
7. Install the "7-Pin Remote Interface Harness" to the P8 connector and turn power "On" to the heater.

See instructions on previous page to activate the remote control.

3-Wire Remote Control Using Three-Position Switch (Pool-Off-Spa, or Low-Off-High)

This application assumes that both heating functions (pool and spa) are required.

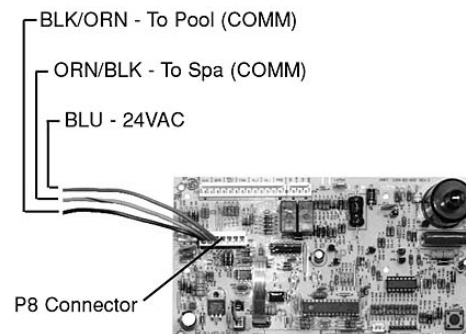

1. Turn on power to the heater.
2. Push the mode button to the "POOL" or "SPA" mode and set the desired temperature for each (eg. 80°F for Pool and 102°F for Spa).
3. Turn the mode button to "OFF" and remove power from the heater.
4. On the "Remote Interface Harness" connect the BLUE wire to one side of the "REMOTE" switch and connect the ORANGE/BLACK wire for "SPA" operation and the BLACK/ORANGE wire for the "POOL" operation.
5. Install the "Remote Interface Harness" to the P8 connector and turn power "ON" to the heater.

See instructions on previous page to activate the remote control.