

AMERICAN SPS, LLC 950 SUNSHINE LANE, ALTAMONTE SPRINGS FL 32714 (866) 322-
POOL (7665) TEL: (407) 831-6154 FAX: (407) 865-5847 SUPPORT@AMERICANSPTS.COM
WWW.AMERICANSPTS.COM

OPERATION MANUAL for the Consumer

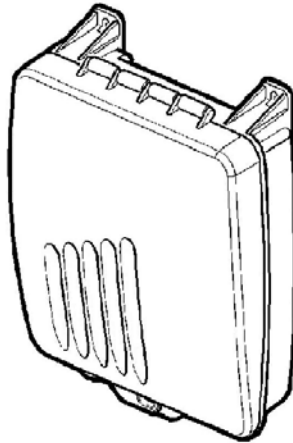

Model: 305PX
September 2009



This is an operating manual for the consumer. A separate installation manual for qualified installers is included.



Important Safety Instructions

Read and Follow All Instructions

All electrical work must be performed by a licensed electrician and conform to all national, state, and local codes. Improper use or installation can badly harm the unit and its surroundings. When installing and using this electrical equipment, basic safety precautions should always be followed, including the following:

DO NOT OPEN THE DISPLAY COVER OF THE BOX – NOT A SERVICABLE UNIT

- Disconnect all AC power before installation.
- WARNING – To reduce the risk of injury, do not permit children to use this product.
- The Control Box must be mounted **vertically** on a flat surface and at a minimum horizontal distance of 5 ft (1.5m) (or more, if local codes so require) from the pool/spa.
- WARNING – Risk of electric shock. Connect only to a grounding type circuit protected by a ground-fault circuit-interrupter (GFCI) outlet. The installer should provide this GFCI requirement. The GFCI should be rated for minimum 6 Amps and tested on a regular basis by pushing the test button. If the GFCI fails to operate correctly, there is ground current flowing indicating the possibility of electric shock. Do not use this unit. Disconnect unit and have a qualified professional correct the problem before using.
- The Input circuit (LN1 & N/LN1) must be connected only after OVERCURRENT DEVICES, such as fuse or circuit breaker to limit the amperage in the input wire to the maximum that is permitted by the National Electrical Code.
- The Unit must be permanent connected, with copper wire, not less than 1.5 mm (14 Awg).
- The wiring of the unit must be performed according to the wiring instructions on page 9 or on the front box cover.
- A build-up of flammable fumes can result in a hazardous condition if the cell is allowed to operate without flow. This device must be operated only with an approved in-line flow sensor.
- The Flow Sensor must be installed between the last piece of apparatus and the Cell.
- Ensure that equipment and materials used in or around the pool and spa are compatible with salt-based sanitation systems. Certain materials may be susceptible to salt and chlorine damage.
- ALWAYS ADD ACID TO WATER, NEVER WATER TO ACID.
- SAVE THESE INSTRUCTIONS.

Table of Contents

Welcome	4
Basic Operation	5
Turbo Setting.....	5
Salt Readout.....	6
Standby Mode.....	7
Pool Cover Function.....	7
pH Clear Functions	8
pH Reducing Modes.....	8
Cell Cleaning Modes.....	9
Maintenance	10
POOL BALANCE:	10
Filtration.....	10
Winterizing:.....	10
Spring Startup:	10
Manual Cell Cleaning for Systems Without pH Clear.....	11
Troubleshooting	12
Adding the Salt	14
Calculating the Size of the Pool	14
Salinity Demand Table (in lbs.).....	15
Pool chemistry explained	16

Welcome

Congratulations on the purchase of your new Natural Chlorine Generator. Your purchase will minimize the efforts needed to maintain your pool and maximize your enjoyment for many years. Before installation or operation, please read these instructions carefully. This manual contains easy to follow step-by-step procedures to properly operate your system. A little time spent understanding your system and its functions will assure successful, trouble-free operation. If you are unsure about any of the information in this manual please contact your installer, dealer or feel free to contact us directly. Additional information about your system can also be found at our website: www.americansps.com

Operating Instructions

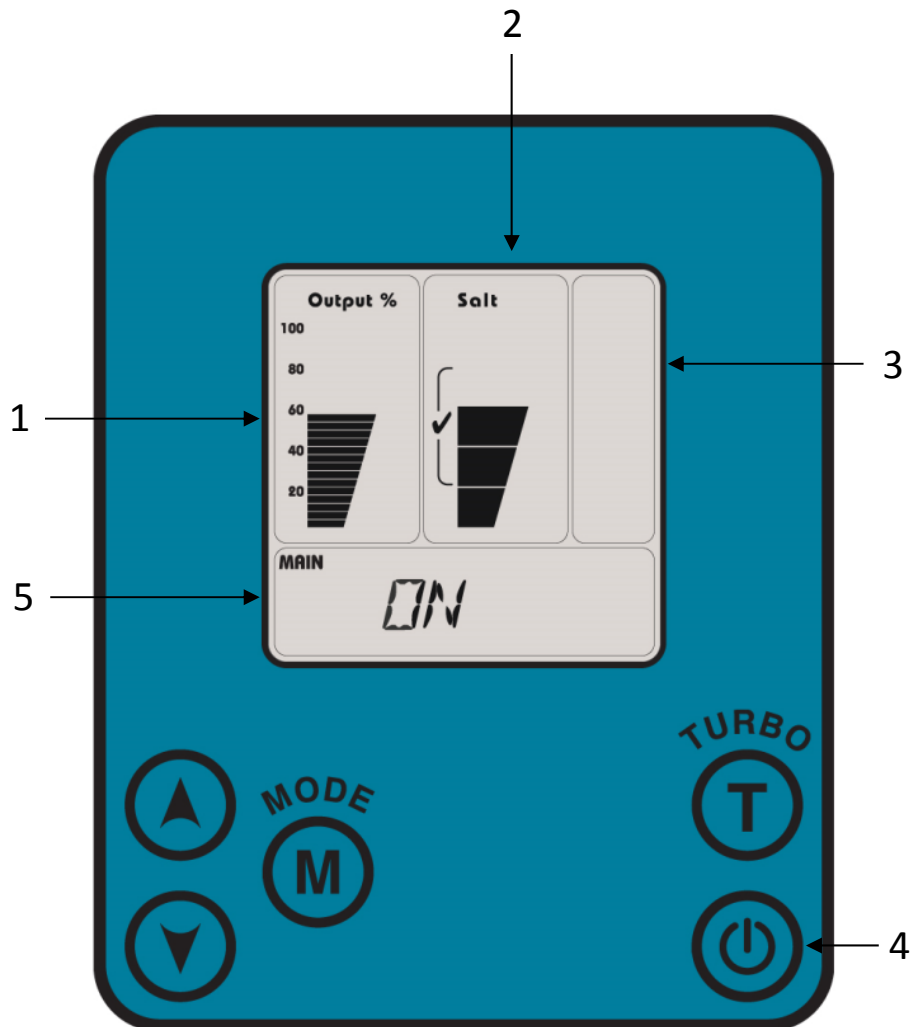



1. Chlorine output level (production level)
2. Salinity level (salt concentration in the water)
3. Special icons

4. ON / OFF
5. General display

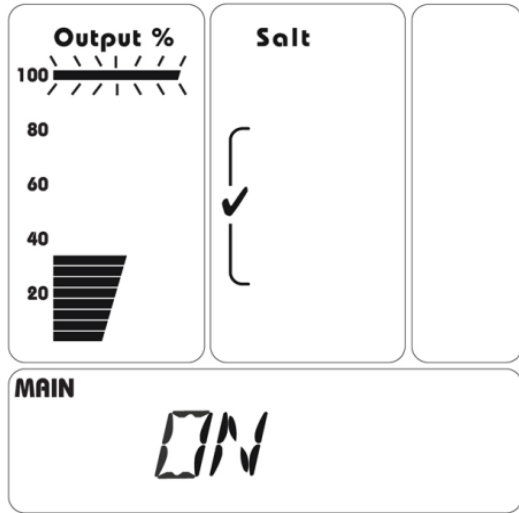
Basic Operation





- Ensure the main circulation pump is ON.
- Press  to turn the unit on.
- Adjust the chlorine production level using the  or  buttons for more or less production.

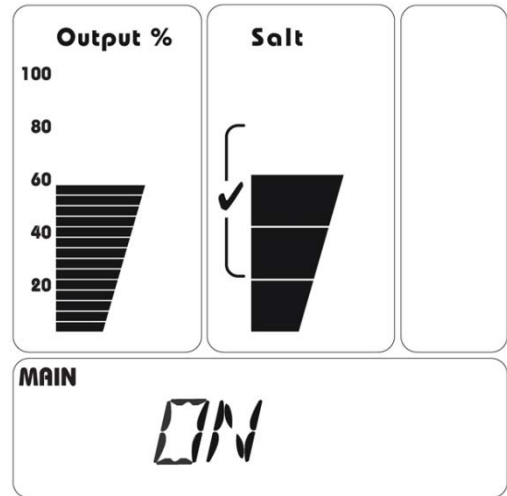

“Wait” up to 1 minute for the system to test and display the Output % and Salinity readings. A blinking bar in the “Output %” area shows the amount of chlorine the system is trying to produce, while the solid bars show the amount of chlorine the system is actually producing.



Turbo Setting

- Press:  (Turbo): this action increases chlorine Output to 100% for a preset period of time. Default is 12 hours.
- Adjust the time by holding the down  or  buttons.



If the salinity level is too low, the solid bars will display the maximum production level the system is reaching, but the 100% bar will blink to show the system is trying to reach the 100% production level.

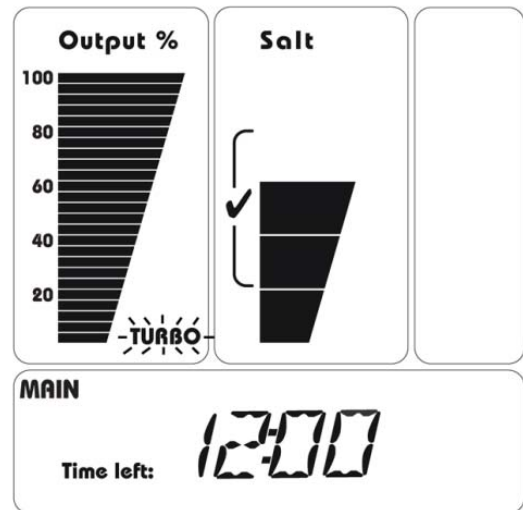

To turn off Turbo wait 5 seconds then press  again.

Salt Readout

Normal salt level: Salt level is normal when the salt level bar is in the “✓” area.

Note: The salt readout takes up to one minute to test and display the salt level.

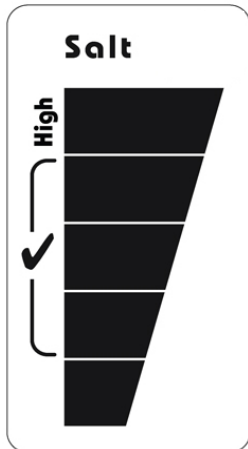
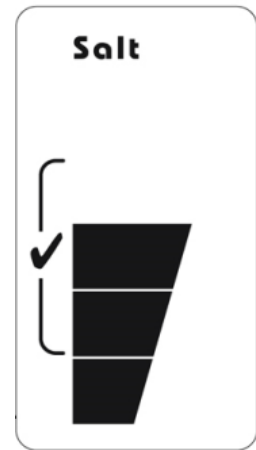

High Salt

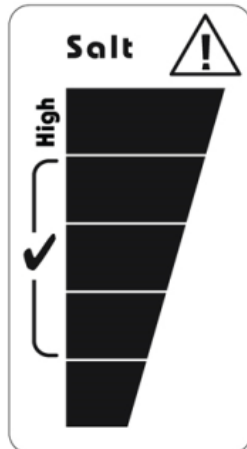

Very High Salt

High Salinity Indication

The system safely operates in up to 10,000ppm of salt, but the “High” salt indicators illuminate to warn against adding more salt. If the High salt indicators stay on, a pool professional should test the water and dilute it as necessary.

CAUTION: Check with your local pool professional prior to draining or diluting the pool.

Low Salinity Indication

Scaling or coating of the cell blades affects the salinity readout. Insure the cell is clean, then have the pool water tested by a pool professional and adjust the salt level to 3000-4000ppm. See the “Adding the Salt” section.

Low Salt

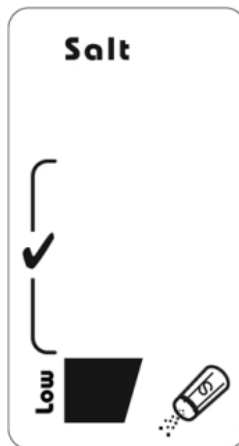

Very Low Salt

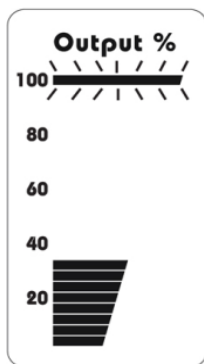
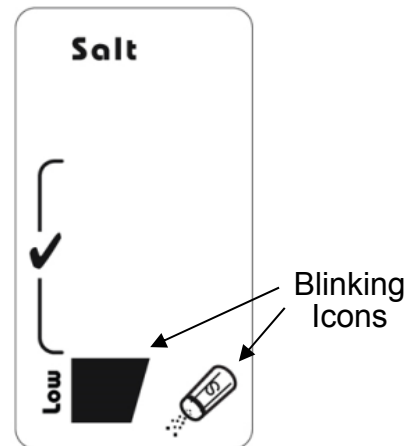

The system safely operates in low levels of salt, but its ability to produce chlorine decreases as the salt level drops below 3000ppm. A blinking bar in the “Output %” area shows the amount of chlorine the system is trying to produce, while the solid bars show the amount of chlorine the system is actually producing.

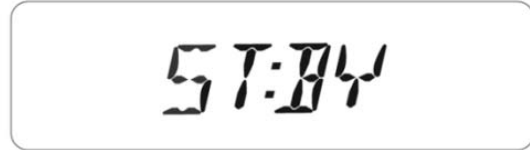

Standby Mode

When the main circulation pump turns off, the system automatically goes into to standby mode. This is a safety action that prevents chlorine production without flow to the chlorinator cell. Automatic cell cleanings are executed during the standby mode. See “pH Clear Functions” section.



Pool Cover Function/AUX Mode (for use with automated retractable covers)

The unique pool cover function enables the chlorinator to reduce the chlorine output while the pool is covered. When the pool cover is closed, the chlorinator will automatically reduce its chlorine output to 20% from the maximum level and a "AUX" note will appear on the numerical display.

Pressing  or  buttons while the system is in "AUX" mode permanently sets new output values to the unit for operation when the pool is covered. For example, the default setting is 20%, but when the pool is covered you may change the default setting to 40%. The setting will return to 40% the next time the pool is covered. In order to activate this function, make sure that the chlorinator unit is getting a "closed" contact from the pool cover control when the pool is covered.



pH Clear Functions

If you purchased the pH Clear add-on, your system can reduce pH levels and automatically acid wash the cell.



If you also purchased the Nexa Balance system, skip the following section and go straight to Cell Cleaning Modes below. Also read through the Nexa Balance manual for proper operation and integration.

The pH reducing modes enable the system to reduce pH levels by periodically infusing small amounts of acid into the pool. More acid units bring pH levels down.

Test the pool water regularly and adjust as necessary.

pH Reducing Modes

Ensure the circulation pump is ON, then press the **M** button to go to the “pH Reducing” modes.

pH Reducing: Auto

Press the **▲** or **▼** buttons to adjust the amount of acid to infuse into the water each week (e.g. 5 Units/Week).

1 Unit \approx 2.5 oz (70 cc).

To eliminate this function, set the “Units/Week” to 0.



pH Reducing: Manual

Use the **▲** or **▼** buttons to infuse the desired number of acid units immediately (e.g. “2 Units Now”).

1 Unit \approx 2.5 oz (70 cc).

To eliminate this function, set the “Units Now” to 0. Turning off the circulation pump also cancels this manual acid infusion.





Cell Cleaning Modes

The pH Clear add-on system ensures the cell remains clean by automatically acid washing it when the circulation pump is off. The factory preset (Level 9) allows a cell wash after the circulation pump logs at least 6 hours of run time. A small amount of acid is used, so this cleaning function has very little influence on the pH level in average pools. In small bodies of water or in acidic environments, the automatic cleanings should be scheduled less frequently.

To Adjust the Frequency of the Automatic Cell Cleanings:

Turn the circulation pump OFF to get to standby mode.

Press the  button to get to the “CELL CLEANING AUTO” mode

Use the  or  buttons to adjust the cleaning level (e.g. Level 3).

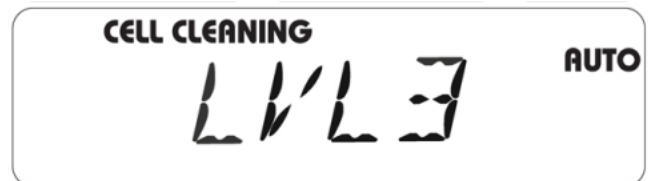



LVL 0 = No cleanings; LVL 9 = most frequent cleanings.

To Initiate an Immediate Cell Cleaning:

Turn the circulation pump OFF to get to standby mode,

Press the  button to get to the “CELL CLEANING MANUAL” mode.

Use the  or  buttons to adjust the strength of the cleaning (e.g. Level 3).

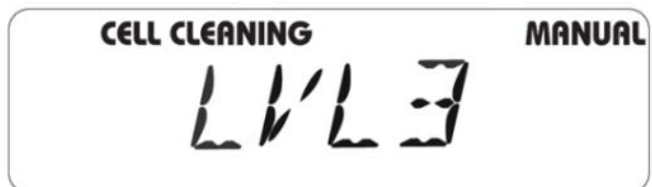

LVL 1 uses 1 unit of acid; LVL 4 uses 4 units of acid. 1 Unit \approx 2.5 oz (70 cc).

Turning the circulation pump ON cancels this manual cleaning function.



If the cell is heavily calcified, the cleaning process can take more than 3 hours. If the cell remains calcified, purge it out by turning the circulation pump on for a few minutes, and then repeat the cleaning function.

Note: Regularly check the integrity of the container, the integrity of the suction tube, and the acid level in the container,

Maintenance

POOL BALANCE:

The following chemistry levels must be monitored and adjusted regularly. They significantly affect the system's ability to maintain pure healthy water as well as the bathers' comfort and safety.

Factors	Ideal Levels
Salt	3500 ppm (3000-4000ppm is acceptable)
Free Chlorine	2 to 4 ppm
pH	7.2 to 7.6
Total Alkalinity	100 to 120 (Up to 180 ok per Sat. Index)
Stabilizer (cyanauric acid)	30 to 50 ppm
Phosphates	0-100 ppb (parts per billion)
Nitrates	0 ppm
Metals	0 ppm
Calcium Hardness	200-400 (Check with your pool finish manufacturer)
Total Dissolved Solids (TDS)	Under 1200
Saturation Index	-0.3 to 0.3

Filtration

Proper filtration is critical for maintaining clean healthy water. It is customarily required in the pool industry that all the water in the pool pass through the filter at least one and a half (1 ½) times per day (at least eight hours on most pools) and that the run time should be during the strongest sunlight hours.

During very heavy use, the filter run time should be increased. If needed, the filter circulation pump and chlorine generator may be run continuously.



Inadequate filtration reduces water clarity and causes harder work for the generator.

Factors such as sunlight, bather load, debris, chemical imbalance and water temperature increase the amount of chlorine needed to keep water clean and safe.

Winterizing:

Just like the pool plumbing, freezing may damage the system Cell and Flow Sensor. If severe or extended periods of freezing temperatures are possible, drain all the water from the pump, filter, cell, supply and return lines before any freezing conditions occur.

Spring Startup:

DO NOT turn on the system until the pool water chemistry has been brought to required levels.

Manual Cell Cleaning for Systems Without pH Clear

Our clear Cell allows easy regular inspections for calcium build up. Visually check the Cell periodically, and clean it as necessary. The pH clear system automates this process. (See “Cell Cleaning Modes” section above).

CAUTION:

Do Not use metal or other hard objects to clean the cell. Do Not insert anything into the cell. Both of these actions could scratch the precious coating on the plates and void the warranty.

CAUTION:

Always add acid to water, NOT water to acid.

Diluted muriatic acid solution = 1 part acid to 10 parts water

Note: Follow the instructions of the acid manufacturer.

Cleaning with Optional Cleaning Cap.

1. Remove the cell from the line by unthreading the barrel unions from the cell ends. There is no need to remove the electrical wire connections when using the cleaning cap.
2. Remove the black O-ring on one end of the Cell.
3. Attach the Cell Cleaning Cap to the other end of cell.
4. Pour into the Cell, either undiluted white distilled vinegar, or a solution of diluted muriatic acid (one part muriatic acid to 10 parts water).
5. Wait for foaming to stop (5-10 minutes when using muriatic acid; vinegar takes longer).

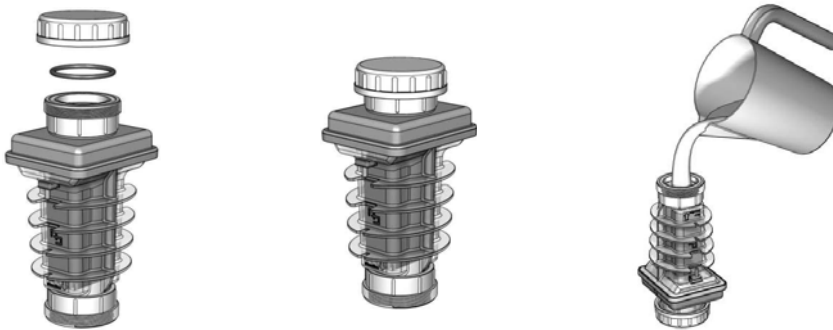

6. Safely dispose of the acid solution by pouring it into your pool.
7. Rinse the cell with water hose.
8. Put the O-ring back in place and re-install the Cell in the line.
9. If the cell cable connectors were removed make sure they are clean and free of debris and re-connect them.

Troubleshooting



Evaluating the possible causes for each problem from top to bottom (First to last) will avoid extra labor.

Problem:	Possible Causes:	What to Do:
1). CHLORINE LEVEL LOW	<ul style="list-style-type: none"> ■ System is turned off. ■ Output level to low due to warmer water, increase in bathers or inclement weather. ■ Low Salt Level. ■ Low stabilizer (cyanauric acid) ■ High phosphate levels. 	<ul style="list-style-type: none"> ■ Turn system on. ■ Increase output setting and/or increase pool pump run time. ■ Test salt, adjust accordingly. ■ Test, adjust to 40 to 50 ppm. ■ Have water tested by pool professional.
2). GREEN POOL	<ul style="list-style-type: none"> ■ Chemical imbalance. ■ Chemical imbalance, dirty filter. 	<ul style="list-style-type: none"> ■ Have water tested by pool professional. ■ Have water tested by pool professional, clean filter.
3). NO LCD DISPLAY	<ul style="list-style-type: none"> ■ System is turned off. ■ Breaker tripped (off). ■ Power wire cut, damaged. ■ Other malfunction. 	<ul style="list-style-type: none"> ■ Turn system on, adjust output level. ■ Check/reset breaker. ■ Check connections. ■ Contact installer or call Technical Support for help.
4). FLOW ICON BLINKING	<ul style="list-style-type: none"> ■ Normal at start-up while pool pump primes. 	<ul style="list-style-type: none"> ■ Should clear itself after a few minutes of run time. (if not, see next)
5). FLOW ICON SOLID ON & NO FLOW MESSAGE APPEARS IN DISPLAY.	<ul style="list-style-type: none"> ■ Insufficient water flow. ■ Obstruction or scale buildup in cell. ■ Flow Sensor Wire Cut. ■ Defective Flow Sensor. 	<ul style="list-style-type: none"> ■ Clean Filters and strainers. ■ Water level low in pool. ■ Check for closed valves, clog in line. ■ Clean Cell (see “cell cleaning”) ■ Check wire to flow sensor. ■ Contact Technical Support.
6). OUTPUT BAR LIGHTS DON'T REACH 100%	<ul style="list-style-type: none"> ■ Output bar set to low. ■ Salt level is low ■ Dirty cell. ■ Dirty cell connectors. ■ Low pool water temperature. ■ Worn Cell. 	<ul style="list-style-type: none"> ■ Push the  button to increase output level. ■ Test pool water add salt accordingly see “Adding the Salt” section for details. ■ Check for debris in the cell, inspect blades for wear & tear or calcium buildup clean if necessary per “Maintenance” section. ■ Make sure cell connectors are clean and snug. ■ Water below 80°F may result in a lower salt reading than actually exists. If in doubt have pool water tested for salt level. ■ If all above checks out ok than cell may need replaced.

Problem:	Possible Causes:	What to do:
7). HIGH SALT	<ul style="list-style-type: none"> ■ Excessive salt has been added to pool 	<ul style="list-style-type: none"> ■ Salt level will come down on its own after time. Or you may have salt level tested and if over 5500ppm you can drain some water out of pool in order to dilute it with fresh water. Consult your pool professional.
8). HIGH SALT ICON ON	<ul style="list-style-type: none"> ■ Salt is very high. 	<ul style="list-style-type: none"> ■ Salt content will need to be reduced through dilution. Have pool tested to determine exact salt level. Pool water will need to be drained to remove excessive salt water in order to dilute with fresh water. Consult your pool professional before proceeding.
9). "SHRT CELL"	<ul style="list-style-type: none"> ■ Salt far too high causing SHRT Cell message. 	<ul style="list-style-type: none"> ■ Salt content will need to be reduced through dilution. Have pool tested to determine exact salt level. Pool water will need to be drained to remove excessive salt water in order to dilute with fresh water. Consult your pool professional before proceeding.
10). "NO CELL"	<ul style="list-style-type: none"> ■ Short circuit in the cell wires. ■ Disconnection in cell cable. 	<ul style="list-style-type: none"> ■ Check cell wires, connections and inspect cell for damage. ■ Check cell wires, connections and inspect cell for damage.
11). "Need Pump"	<ul style="list-style-type: none"> ■ pH Clear Pump is not connected ■ Trying to reach to the pH Clear system modes when the pump is not installed. 	<ul style="list-style-type: none"> ■ pH clear pump disconnected The unit automatically identifies connection of pH clear system to the controller. ■ pH clear pump option available through your dealer.

Adding the Salt

1. Measure the pre-existing salinity of your pool. Previous use of liquid chlorine may have created a residual level of salt in your pool.
2. Determine how much salt is needed from the **pool volume calculator and salinity demand table on the following pages**. This table is based on a salt concentration of 3500 ppm
3. Keep the circulating pump on.
4. Distribute the determined amount of salt evenly around the pool. To avoid clogging the filter or damaging the Control Box and pump, do not add salt through the skimmer brush the bottom of the pool to help dissolve the salt.
5. The readout on the chlorine generator may fluctuate until the salt is fully dissolved.

GOOD Acceptable Salts

BAD – do NOT to use:

Granulated <u>Pool Salt</u>	Iodized Salt
	Salt with more than 1% anti-caking agents
	Rock Salt, Water Softener Salts
	Calcium Chloride (not salt). Use Sodium Chloride Only

Calculating the Size of the Pool

	Gallons (Dimensions in feet)	Liters (Dimensions in meters)
Rectangle	Width X Length X Average Depth X 7.5 = Gallons	Length x Width x Average Depth x 1000 = Liters
Round	Diameter x Diameter x Average Depth x 5.9 = Gallons	Diameter X Diameter X Average Depth X 785 = Liters
Oval	Length X Width X Average Depth X 6.7 = Gallons	Length X Width X Average Depth X 893 = Liters

Use the above chart to determine the water volume of your pool

Example: 15' X 30' Rectangle Pool 3' shallow end, 6' deep end.

$$15^{\text{wide}} \times 30^{\text{long}} = 450^{\text{sq ft}} \times 4.5^{\text{avg depth}} \times 7.5^{\text{gal per cubic ft}} = 15,147$$

Salinity Demand Table (in lbs.)

		Salt level before addition (in PPM)								
		0	500	1000	1500	2000	2500	3000	3500	4500
		How much salt to add (in pounds)								
Water volume in thousands of Galloons	4	117	100	83	67	50	33	17	0	OK
	6	175	150	125	100	75	50	25	0	OK
	8	234	200	167	133	100	67	33	0	OK
	10	292	250	209	167	125	83	42	0	OK
	12	350	300	250	200	150	100	50	0	OK
	14	409	350	292	234	175	117	58	0	OK
	16	467	400	334	267	200	133	67	0	OK
	18	525	450	375	300	225	150	75	0	OK
	20	584	500	417	334	250	167	83	0	OK
	22	642	550	459	367	275	183	92	0	OK
	24	701	600	500	400	300	200	100	0	OK
	26	759	651	542	434	325	217	108	0	OK
	28	817	701	584	467	350	234	117	0	OK
	30	876	751	626	500	375	250	125	0	OK
	32	934	801	667	534	400	267	133	0	OK
	34	992	851	709	567	425	284	142	0	OK
	36	1051	901	751	600	450	300	150	0	OK
	38	1109	951	792	634	475	317	158	0	OK
	40	1168	1001	834	667	500	334	167	0	OK
	42	1226	1051	876	701	525	350	175	0	OK
44	1284	1101	917	734	550	367	183	0	OK	
46	1343	1151	959	767	575	384	192	0	OK	
48	1401	1201	1001	801	600	400	200	0	OK	
50	1460	1251	1043	834	626	417	209	0	OK	

Locate the current salt concentration at the top of the chart (e.g. 1000 ppm). Then locate the size of your pool on the left (e.g. 12,000 gallons). Run these figures down and across until they meet. That number is the number of pounds of salt required for your pool.

Pool chemistry explained

Salt is the power source of the Natural Chlorine Generator. The ideal salt level to ensure maximum benefits using our system is 3500 ppm (parts per million). A low concentration of salt may hinder the generator effectiveness. A concentration of salt above 5500 ppm may cause corrosion damage to the pool fixtures. See the Adding Salt section for more information.

Free Chlorine vs. Combined Chlorine: The unpleasant smells and side effects often associated with chlorine are actually caused by combined chlorine (i.e., chloramines). Combined chlorine is a chlorine molecule that attacks a noxious particle in the water but is unable to destroy the noxious particle. This chlorine particle remains attached to the noxious particle until one of the two is burned off; hence the term Combined Chlorine (a.k.a. chloramines). To burn off the noxious particle and free up the chlorine again, pool owners have to shock (with chlorine) the pool periodically, but with the Natural Chlorine Generator, the noxious particles are burned off within the generator Cell and the combined chlorine is continuously converted back to free chlorine. The free chlorine level in the pool should be maintained at 2 to 4 ppm. This level of free chlorine is comfortable to swim in with no unpleasant smells, and maintains proper sanitizing power.

pH is a measure of the acidic or basic solution. A scale of 0 to 14 is used to measure pH. Pure water has a pH of seven (neutral), acid solutions have a pH of less than seven, and basic (alkali) solutions have a pH of more than seven. The recommended range is 7.2 to 7.6; chlorine is much more effective within this range and the water is most comfortable for bathers. **pH levels above 7.8 drastically reduce the effectiveness of the chlorine.** To lower the pH, add muriatic acid or dry acid. Be sure to read and follow the respective manufacturer's instructions.

Total Alkalinity mitigates changes in pH. It is often referred to as the "big brother of pH." Keeping proper levels of total alkalinity helps reduce unwanted fluctuations in pH levels. Total alkalinity is also used to offset high or low levels of calcium hardness. Add muriatic acid or dry acid to lower the total alkalinity and sodium bicarbonate to raise the total alkalinity. Be sure to read and follow the respective manufacturer's instructions.

Stabilizer (Cyanuric Acid or Conditioner) is necessary in most outdoor pools to maintain appropriate levels of chlorine. Chlorine stabilizer helps provide an appropriate residual chlorine level in the water. Without stabilizer, UV radiation from the sun destroys most chlorine within 2 hours, but excessive amounts of stabilizer can decrease the effectiveness of chlorine. Chlorine stabilizer should be maintained at 60 ppm to offset the harmful effect of the sun while maintaining the effectiveness of the chlorine. Where pH/ORP automatic sensors are used, 40 ppm of stabilizer suffices.

Phosphates and Nitrates set very high demands on chlorine; most often nitrates and phosphates bring the chlorine level down to zero (0). You can have your water tested for nitrates and phosphates by the local pool professional. **Your pool should NOT contain Nitrates or Phosphates.** To reduce Phosphate levels, use a phosphate remover from your local pool professional. To reduce Nitrate levels, the pool must be partially or fully drained. (Please check with your local pool professional prior to draining the pool).

Metals can cause loss of chlorine and can stain your pool. If a water test reveals the presence of metals, refer to your local pool professional for recommended methods of removal. Be sure to use a phosphate-free metal remover to avoid replacing a metal problem with a phosphate problem.

Calcium Hardness, like pH and alkalinity, affects the water tendency to be aggressive\ or scale forming. Lower levels of calcium hardness improve the chlorine generator ability to stay clean and provide softer silkier water for the swimmers. Check with your pool professional for proper calcium levels for your pool surface.

Total Dissolved Solids (TDS) is a measure of many types of dissolved materials, including salt. High effective TDS levels (i.e., 1500 ppm and up) cause cloudy water and significantly increase chlorine demand. To obtain the effective TDS level in a pool using a salt system, subtract the salt level from the TDS reading. (e.g., 5000 TDS – 4000 Salt = 1000 effective TDS).

Saturation Index determines whether the pool water is balanced, aggressive, or scale forming by comprehensively taking into account all the relevant factors, including pH level, alkalinity level, calcium hardness, and temperature. These factors should be tested periodically, and then included into the worksheet on the following page to verify the proper balance of the pool and make adjustments as necessary.