

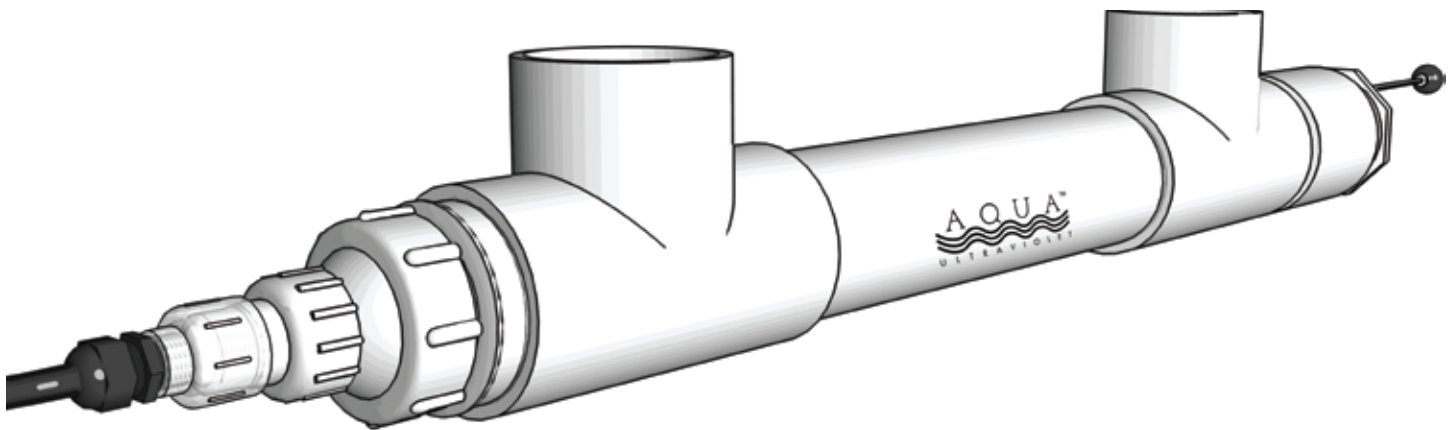

42371 Avenida Alvarado
Temecula, CA 92590
TOLL FREE (800) 454-2725
TEL (951) 296-3480
FAX (951) 296-3490
www.aquauv.com

Aqua Ultraviolet

UV Sterilizer Instruction Manual for SL Series Units



SEE PAGE 4 FOR COMPLETE LINE OF SL UNITS



Find us on Facebook
www.facebook.com/AquaUltraviolet



Follow us on Twitter
www.twitter.com/aquaultraviolet



See us on YouTube
www.youtube.com/AquaUltraviolet

BLOG

Read about us on WordPress
<http://aquaultraviolet.com/WordPress>

TABLE of CONTENTS

Important Information.	1
Warranty.	2-3
SL 100 and SL 200 Illustrations.	4
How Ultraviolet Works.	5
Sizing Chart.	5
Frequently Asked Questions.	6
Parts List.	7-8
Recommended Pond & Aquarium Layouts.	9
Installation Instructions.	10-13
Electrical Installation.	14-15
Maintenance.	16
Changing the Lamps.	17
Wiper Maintenance.	17-19
Cleaning the Quartz Sleeve.	20
Installing a Replacement Quartz Sleeve.	20-21
Incorrect Installation.	22

THIS SECTION CAN BE USED FOR NOTES:

IMPORTANT INFORMATION



THANK YOU FOR PURCHASING THE BEST ULTRAVIOLET SYSTEM

WE CAN HELP YOU

Returning the product is expensive and time consuming for you, your retailer and for us, the manufacturer. Should you encounter any problems with your product, please call our toll free "HELP" line for assistance. **PLEASE DO NOT** return your product to the store! Your dealer or distributor cannot offer any warranty work or exchanges on your product.



**In the US please call
TOLL FREE 1 - 800 - 454 - 2725
(951) 296-3480 Outside the U.S.
THANK YOU!**

WARRANTY

Aqua Ultraviolet systems are warranted against failure due to defects in materials and/or workmanship during the warranty period. This warranty covers defects occurring under normal use and applies to the original purchaser at retail and may not be transferred. The warranty and remedies set forth herein are conditional upon proper storage, installation, use, maintenance and conformance with the applicable use. It will be based upon Aqua Ultraviolet's discretion as to whether the defects are of manufacturing origin. Any damages due to shipping and handling, packing, or installation are not covered by this warranty.

This warranty does not apply to appearance or accessory items. This warranty does not include damage due to handling, transportation, unpacking, set up, installation, repair or replacement of parts supplied by any other than Aqua Ultraviolet, improper maintenance, incorrect line voltage, modification, or repairs by the purchaser, abuse, misuse, neglect, accident, fire, flood, or other acts of God.

Any oral statements about product made by the seller, the manufacturer, their representatives or any other parties do not constitute warranties and shall not be relied upon by the user and are not part of this contract.

Neither the seller nor the manufacturer shall be liable for any injury, loss or damages, direct, incidental or consequential including but not limited to incidental or consequential damage for lost profits, lost sales, injury, inability to use the product and the user agrees that no other remedy is available.

Before using, the user shall determine the suitability of the product for their intended use and the user shall assume all risk liability whatsoever in connection therewith.

To validate this warranty, mail the enclosed warranty card within 10 days of purchase along with proof of purchase (copy of sales receipt).

Warranty Period:

Housing: Limited lifetime warranty on housing against Ultraviolet degradation.

Complete Unit: One year from the date of purchase or 18 months from manufacturing date.

Limitations:

Warranty does not cover any malfunction from improper installation (we recommend that an authorized dealer or licensed electrician install your system to the specifications outlined in this owners guide).

Warranty only applies to the original end user and is not transferable.

Warranty does not cover repairs done by anyone other than Aqua Ultraviolet.

Warranty is void if system is not plugged into a GFCI (ground fault current interrupter).

Warranty may not be modified by verbal statements by Aqua Ultraviolet, distributors, retailers, their agents or any other party.

Warranty covers the repair or prorated replacement of the Aqua Ultraviolet products. Aqua Ultraviolet denies all liability for any other loss including but not limited to loss of equipment, income, livestock or personal injury.

There is no warranty on the Quartz Sleeve.

There is no warranty on broken lamps. Lamps are prorated by usage.

Warranty is voided by the following:

Use of anything other than Genuine Aqua Ultraviolet parts.

Product labels defaced or removed.

Housing has been painted.

Product is improperly installed or maintained by user or agent.

Product abused, misused or damaged by user or their agent.

Product damage caused by electrical surges, electrical spikes, electrical brown outs or Improper voltage.

Electrical cord has been cut.

WARRANTY CONTINUED:

Any implied warranty granted under state law including warranties of merchantability or fitness for a particular purpose are limited to one year from the date of purchase or 18 months from the date of manufacture or as otherwise stated in the above warranty. Aqua Ultraviolet is not responsible for direct, indirect, incidental or consequential damages. Some states do not allow limitations on how long an implied warranty lasts and/or does not allow the exclusions or limitations of incidental damages so the above limitation and exclusion may not apply to you. This warranty gives you special legal rights and you may also have other rights that vary from state to state.

Warranty Returns or Repair Returns:

Please call Aqua Ultraviolet at (800) 454-2725 for a "Return Merchandise Authorization" number (RMA). You must have a valid RMA from an Aqua Ultraviolet customer service representative before sending any product in for warranty or repair. Please have your serial number, date of purchase and product type available when calling for an RMA number.

All warranty returns or repair returns must come freight prepaid with an RMA number outside clearly marked on the box. All other returns will be refused. Aqua Ultraviolet will not be liable for any shipping cost to return warranty or repair items. Include a note in the box with your RMA number, name, address, daytime phone number and brief description of the reason for return or repair.

Be sure to return product in the same packing or similar packing and insure the package (we recommend sending it UPS). If you do not have or can't locate proper packaging, please call our customer service department and we will be more than happy to send you packaging for a minimal charge.

Aqua Ultraviolet shall not be responsible for damage or loss done by the shipper. Nor shall Aqua Ultraviolet be responsible for merchandise that arrives damaged due to improper packaging. All claims for loss and damage must be filed by the customer with the shipper.

If unit is found to be out of warranty we will contact you with the cost of repair. Your authorization is required prior to making any repairs.

THIS SECTION CAN BE USED FOR NOTES:

SL 100 WATT - and SL 200 WATT UNITS & TRANSFORMERS

**SL 100 Watt Unit
220V/60Hz**

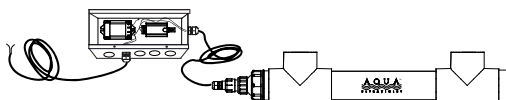

**1 - 100 Watt Trans.
1 - Ignitor**

**SL 100 Watt Unit
With Wiper
220V/60Hz**

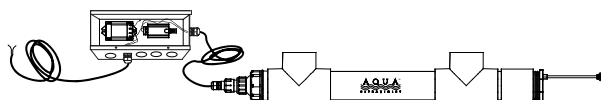

**1 - 100 Watt Trans.
1 - Ignitor**

**SL 100 Watt Unit
110V/60Hz**

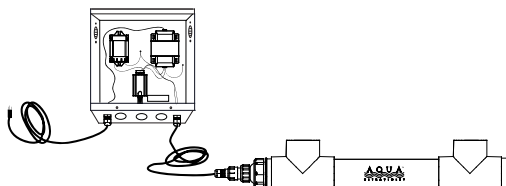

**1 - 100 Watt Trans.
1 - Step Trans.
1 - Ignitor**

**SL 100 Watt Unit
With Wiper
110V/60Hz**

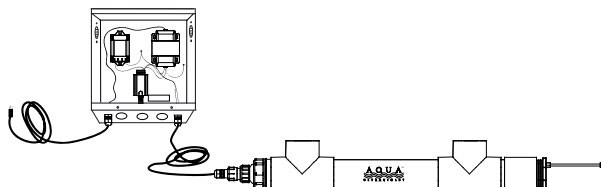

**1 - 100 Watt Trans.
1 - Step Trans.
1 - Ignitor**

**SL 200 Watt Unit
220V/60Hz**

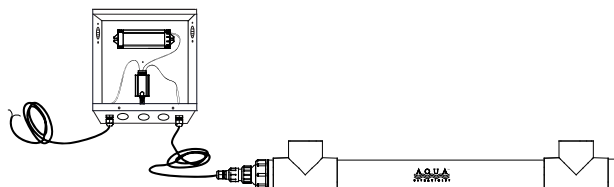

**1 - 200 Watt Trans.
1 - Ignitor**

**SL 200 Watt Unit
With Wiper
220V/60Hz**

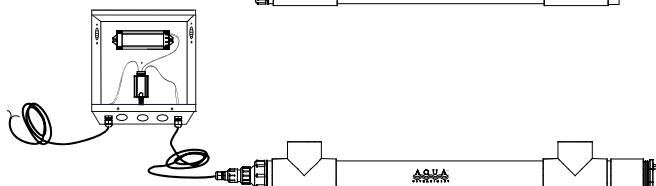

**1 - 200 Watt Trans.
1 - Ignitor**

**SL 200 Watt Unit
110V/60Hz**

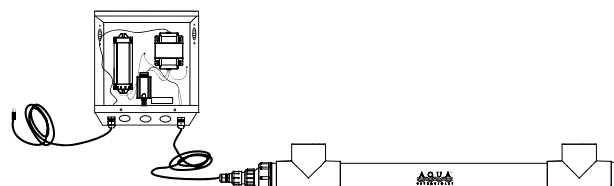

**1 - 200 Watt Trans.
1 - Step Trans.
1 - Ignitor**

**SL 200 Watt Unit
With Wiper
110V/60Hz**

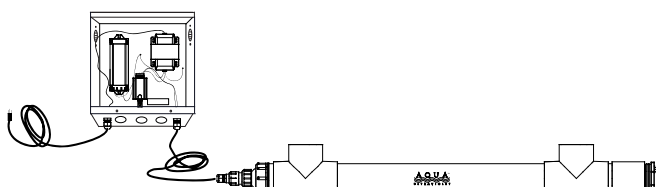

**1 - 200 Watt Trans.
1 - Step Trans.
1 - Ignitor**

INTRODUCTION

We at Aqua Ultraviolet would like to take the time to thank you for purchasing the finest ultraviolet system on the market.

For over twenty years, Aqua Ultraviolet has manufactured ultraviolet systems which are in use in many different fields and industries such as aquariums, aquaculture, public and commercial aquariums, educational institutions, government agencies and commercial and research organizations throughout the world.

Aqua Ultraviolet sterilizers are used to destroy single celled organisms such as water borne bacteria, viruses and/or to control algae and/or to kill fungi and protozoa. Aqua Ultraviolet sterilizers are recommended for both fresh and salt water systems as well as ponds. There are no residual effects when using an Aqua Ultraviolet sterilizer. Ultraviolet will not affect Bio-filters or lower fish immune systems!

HOW ULTRAVIOLET WORKS

The ultraviolet lamp emits a germicidal ray which alters or disrupts the DNA or RNA of targeted organisms such as algae, bacteria and protozoa. By properly implementing an Aqua Ultraviolet system in-line, the targeted organisms can be eradicated effectively without any harmful residuals.

The Aqua Ultraviolet sterilizer works better on filtered water. Any debris in the water can inhibit UV transmission.

CAUTION: READ ALL INSTRUCTIONS CAREFULLY BEFORE BEGINNING INSTALLATION OR OPERATION.

The following instructions should answer most of the questions that you may have about the installation, operation and use of your new Aqua Ultraviolet Sterilizer. If for some reason you should need technical support, we offer this service for free by telephone (800) 454-2725, or by fax (951) 296-3490 M-F 8:00 am - 4:30 pm Pacific Standard time except selected holidays or you may reach us through the web at www.aquaultraviolet.com.

SIZING CHART:

UV Units	# of Lamps	120V Amp Draw	240V Amp Draw	Size Fresh Water Pond Sterilizer* in Gallons	UV Dosage $\mu\text{w}/\text{cm}^2$ EOL					Size Fresh Water Pond Clarifier*** in Gallons	Max Flow Rate	**Salt Water Tank Gallons
					Max Flow (GPH)							
					30,000 $\mu\text{w}/\text{cm}^2$ (EOL) GPH	45,000 $\mu\text{w}/\text{cm}^2$ (EOL) GPH	60,000 $\mu\text{w}/\text{cm}^2$ (EOL) GPH	75,000 $\mu\text{w}/\text{cm}^2$ (EOL) GPH	90,000 $\mu\text{w}/\text{cm}^2$ (EOL) GPH			
SL 100 Watt	1	5.55	1.20	8,500 - 13,000	6,600	4,400	3,300	2,640	2,200	20,000	10,000	900
SL 200 Watt	1	7.35	3.00	17,000 - 22,000	9,200	6,134	4,600	3,680	3,066	30,000	15,000	1800

*As sterilizer (for crystal clear water), UV dosage is 30,000 $\mu\text{w}/\text{cm}^2$ (EOL) at max flow rate.

**Salt water gallons based on higher UV kill rate (targeting free floating parasites) and tank turnover of 3-5 times per hour.

***As clarifier, water clarity dependent on amount of sun, local temperatures, plant coverage, shallowness of pond, etc.

FREQUENTLY ASKED QUESTIONS

Where do I install my UV?

The best place to install your Aqua Ultraviolet Sterilizer is after the filter. If an after the filter installation is not feasible, your sterilizer can be installed before the filter, but it will take a little longer to work. If installed before the filter, be aware that a small rock passing from the pump can break the quartz sleeve. It is recommended that if you install your unit before your filter, you check the UV periodically for any water leakage due to a broken quartz sleeve. Be sure to have adequate pre-filtration to prevent breakage. (A broken quartz sleeve and any damage caused by a broken quartz sleeve is not covered under warranty.)

Do I have to turn my UV off when I clean my filter?

Yes, the SL Units are completely water cooled, and should not be run without water or when water is at a stand still for any length of time. This may cause extensive, irreversible damage to the unit and is not covered under warranty.

What should I expect after my UV is installed?

If your Aqua Ultraviolet system is installed after the filter and is properly sized the water should be clear in 3-5 days. If your Aqua Ultraviolet system is installed before the filter the water should be clear in 7-10 days. The green algae on the sides and bottom of the pond will not disappear, this is normal in a pond. The UV doesn't control this type of algae.

What's the difference between a sterilizer and a clarifier?

As a sterilizer, your Aqua UV system will keep your pond or aquarium water crystal clear in addition, you will have the added benefit of bacterial control which will help keep your fish healthy and happy with less risk of disease.

As a clarifier your pond will still have a green tint to it, unless you have 50-75% plant coverage or your pond is in full shade.

Do I install my UV vertically or horizontally?

You can install your Aqua Ultraviolet system either way. (Please see **INSTALLATION INSTRUCTIONS** on page 10).

What should my flow rate be on my pond or fresh water aquarium?

The optimum flow rate on your pond or fresh water aquarium is to turn over the volume of water once every hour or a minimum of once every other hour.

What should my flow rate be on my salt water aquarium?

Your flow rate should be 3-5 times the volume of water per hour.

Should I bypass part of my water through the UV and the rest back to the water supply?

No. Our UV was specifically designed to handle high flow rates for easier installation and the best water quality.

Is this unit submersible?

Not this specific series.

Does the UV light have any residual effect to the fish?

UV only affects what passes through the chamber. There is no residual effect from UV light.

Does the UV kill good bacteria?

Ultraviolet light does not discriminate about what it destroys. If good bacteria passes by the light it will be destroyed. Good bacteria are colonized in your filter, along the sides and bottom of your pond. The only time it will be affected is if it becomes free floating. All the bacteria in the filter are safe because UV has no residual.

PARTS LIST UNITS

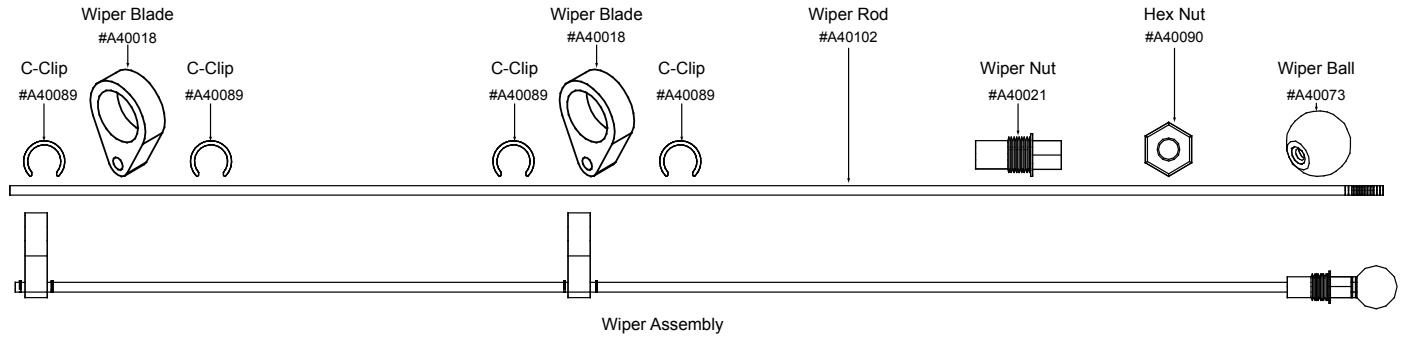
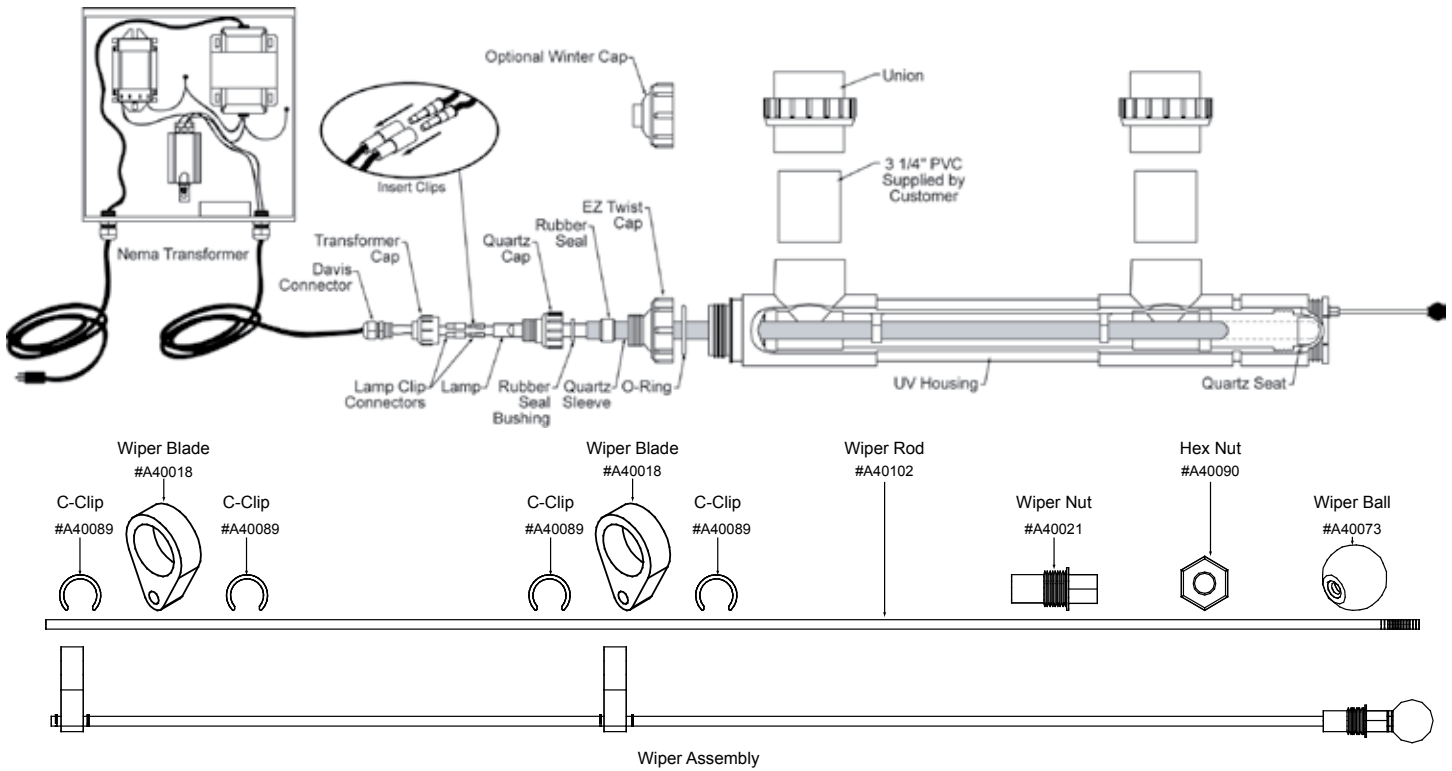

Part #	Description	Part #	Description	Part #	Description	Part #	Description
A40041	SL 3" Wiper Assembly Threaded Plug	A40042	SL Quartz Cap	A40073	Wiper Ball	A40021	Wiper Nut
A40022	EZ Twist Cap	A40006	SL Rubber Seal	A40018	SL Wiper Blade	A40102	100 Watt Wiper Rod
A40015	Rubber Seal Bushing	A40082	3" Union	A40089	Wiper Clips	A40060	200 Watt Wiper Rod
A40014	O-Ring	A40007	Winterized Cap	A40090	Wiper Hex Nut	A40061	SL Lamp Clip Connector

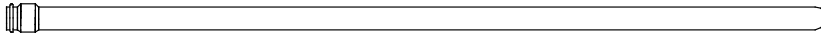
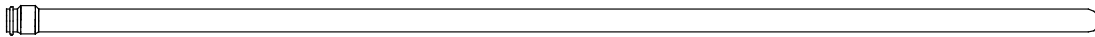
Quartz Sleeve		Part Number
		A10100
100 Watt		
		A10200
200 Watt		

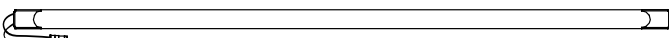
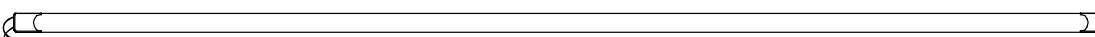
UV Lamps		Part Number
		A20100
100 Watt		
		A20200
200 Watt		

PARTS LIST CONTINUED

**100 Watt Nema Transformer
110V/60Hz**

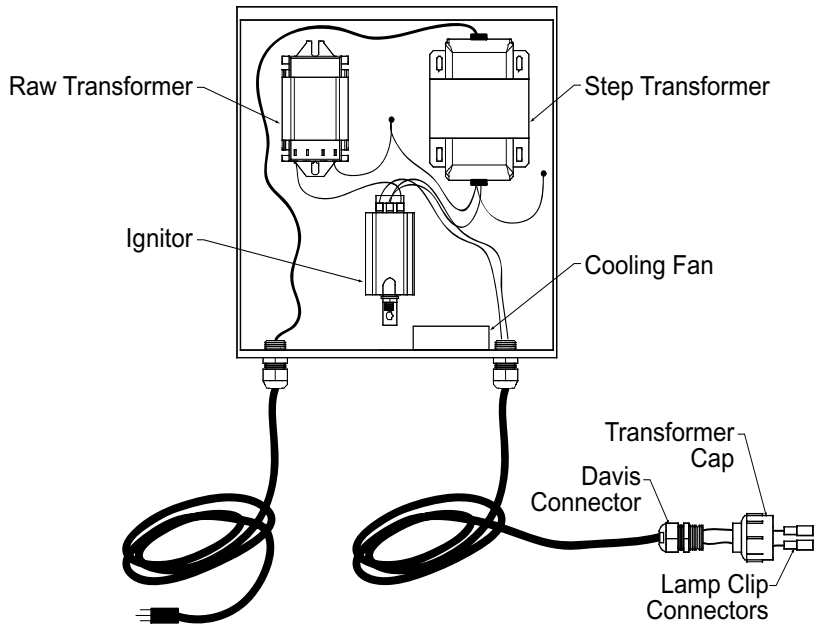

**100 Watt Nema Transformer
240V/60Hz**

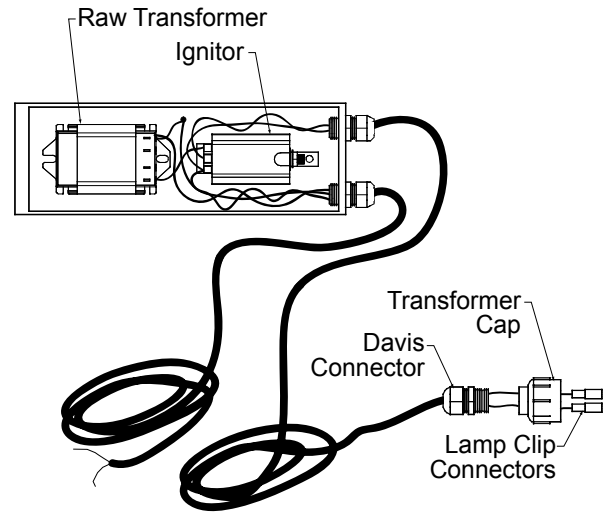

**200 Watt Nema Transformer
110V/60Hz**

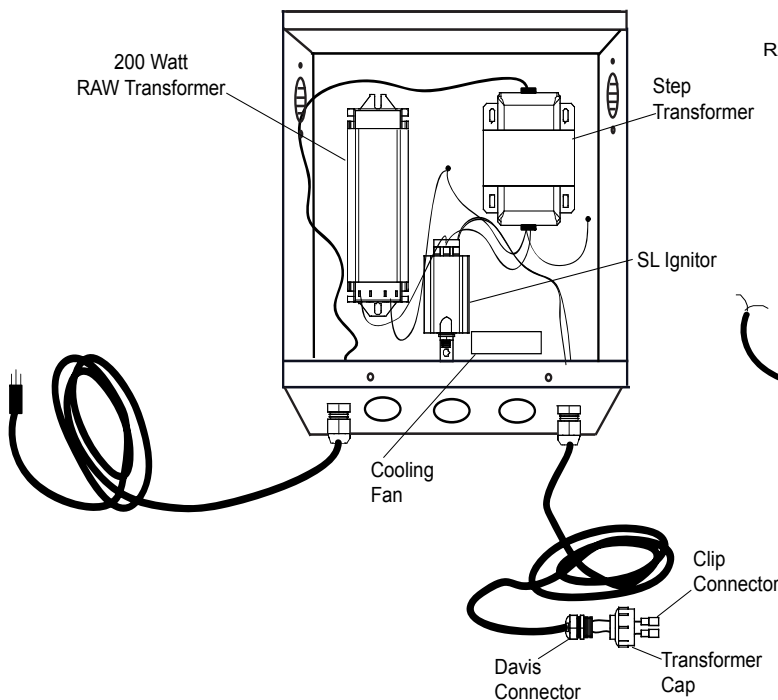

**200 Watt Nema Transformer
240V/60Hz**

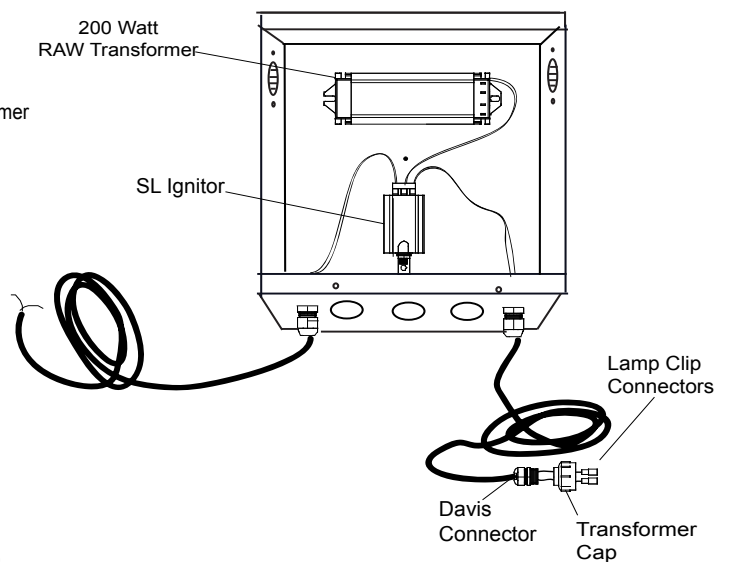

Part #	Description	Part #	Description	Part #	Description
A30100	SL 100 Nema Transformer 240V	A30207	SL 200 Raw Transformer	A40109	Davis Connector
A30101	SL 100 Nema Transformer 110V	A30103	SL Ignitor	A40095	SL 100 Watt Wiring Harness
AS39200	SL 200 Nema Transformer 240V	A30106	SL Step Transformer	A40075	SL 200 Watt Wiring Harness
AS39201	SL 200 Nema Transformer 110V	A40061	SL Lamp Clip Connector	A40167	SL Cooling Fan
A30102	SL 100 Raw Transformer	A40023	Transformer Cap Clear		

RECOMMENDED POND LAYOUTS

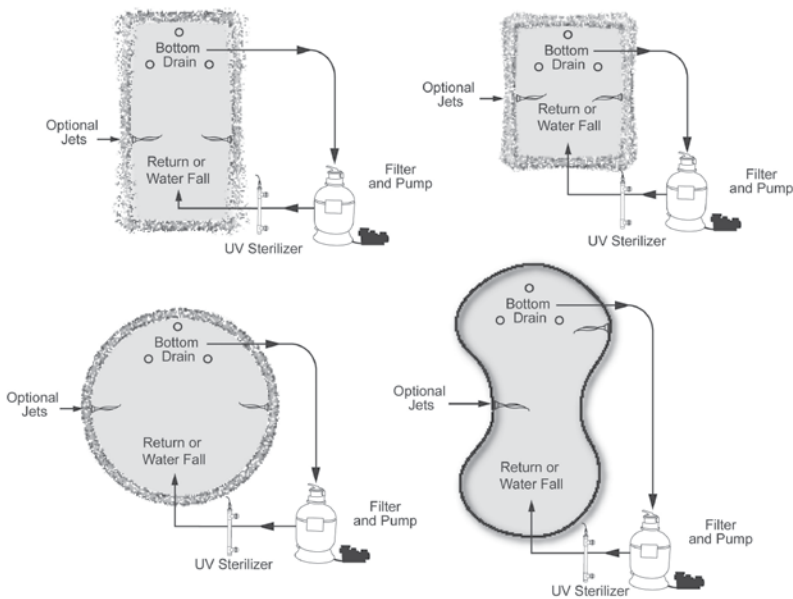

Incorrect Installation

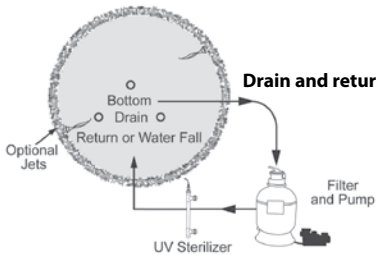

Incorrect Installation

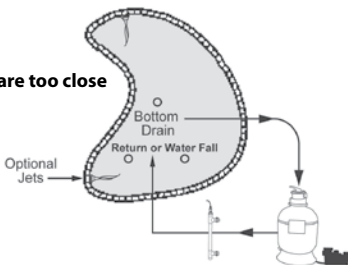

RECOMMENDED INDUSTRIAL/RETAIL AQUARIUM LAYOUT

Pick up at the bottom of the tank and return to top of opposite end

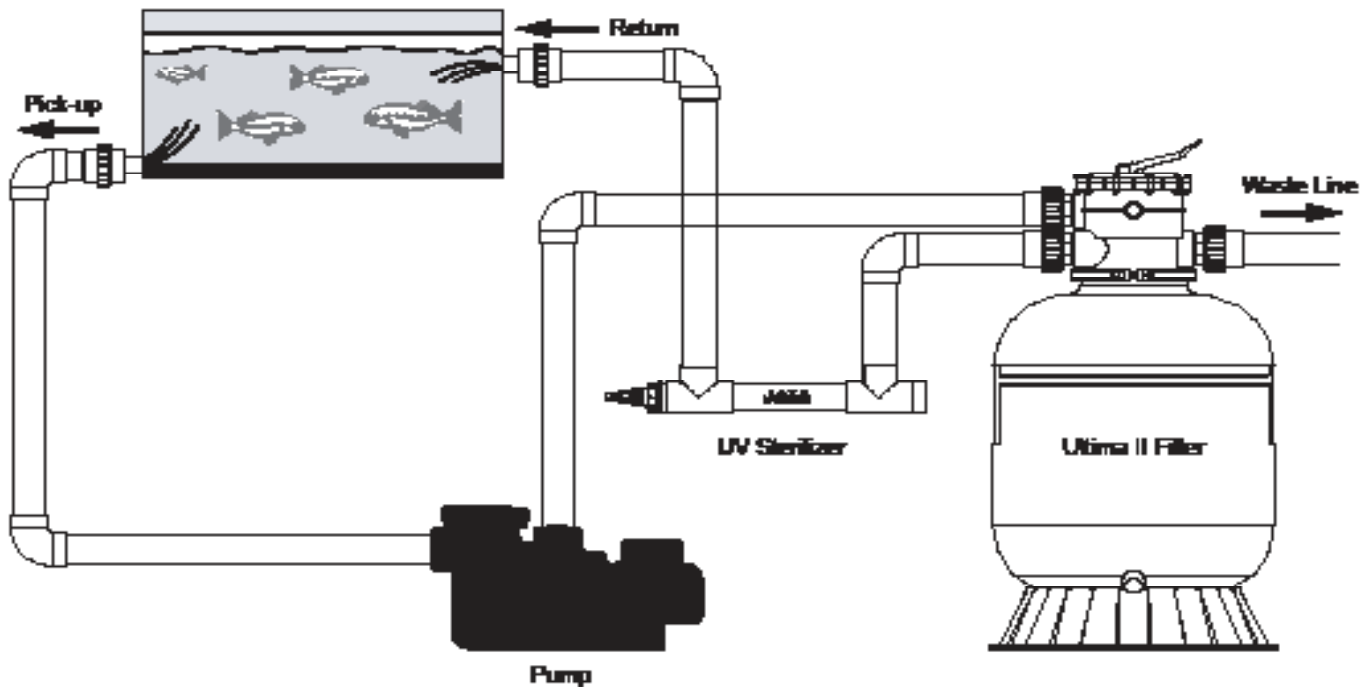

HOUSING INSTALLATION INSTRUCTIONS

NOTE: All units are quality tested from the factory. All units are rated up to 50 PSI.

1. MOUNTING: Mount your Aqua Ultraviolet system horizontally or vertically on a wall or above ground, on a level and firm surface. Do not lay the system on the ground or where water may puddle. Your system should be easily accessible and as close to the filter as possible. Do not submerge. Remember on units with the wiper option allow enough room to pull the wiper all the way out. On all units allow space to change the lamp and quartz sleeve. Below are Aqua Ultraviolet's suggested installation instructions.

INSTALLATION SUGGESTIONS (HORIZONTAL)

SL 100, SL 200 Watt Units:

If your unit has a wiper plumb the water going down into the sterilizer at the end closest to the wiper rod and up out of the end closest to the transformer. This will ensure the chamber stays full of water and the wiper rod) does not push out. Non wiper units can use either port as inlet.

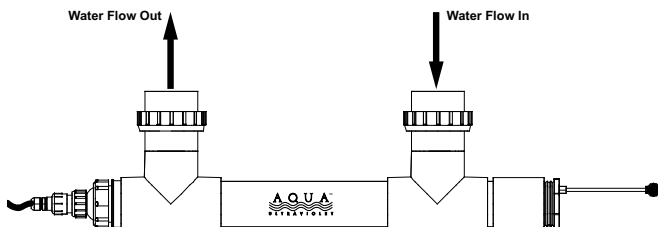

INSTALLATION SUGGESTIONS (VERTICAL)

Plumb the water going in the bottom of the sterilizer and coming out of the top. This will ensure the chamber stays full of water and the wiper rod) does not push out.

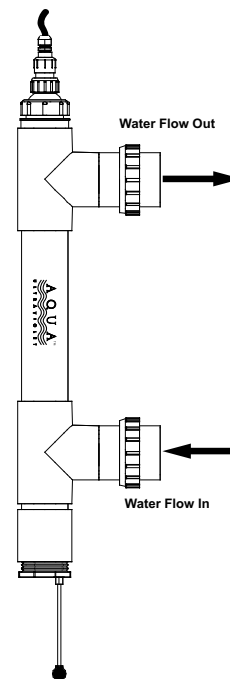

The above are suggestions, if you choose to install your unit in any manner other than the suggested, you must ensure that the pump is strong enough to completely fill the chamber. If the water flow does not fill the chamber the wiper nut may dry out causing a leak, and if left unattended the chamber will overheat and cause irreversible damage that is not covered under warranty.

CAUTION: In a vertical installation be careful not to drop the lamp down inside the unit, this can break the quartz sleeve. The quartz sleeve is not warranted against breakage nor is any damage caused as a result of a broken quartz sleeve. (SEE ILLUSTRATION ON PAGE 22.)

NOTE: You can use mounting brackets or plumbers straps to attach your unit to a wall or firm surface.

WARNING: Before mounting or installing your unit check the quartz sleeve. Do not try to install, mount or operate this unit if the quartz sleeve appears to be broken or cracked. If broken or cracked contact your dealer.

IMPORTANT

INSTALL UNIT WITHOUT LAMP AND BALLAST. PUMP WATER THROUGH. CHECK FOR LEAKS THEN INSTALL LAMP AND BALLAST!

READ AND FOLLOW ALL INSTRUCTIONS AND/OR SAFETY INSTRUCTIONS FIRST!

HOUSING INSTALLATION INSTRUCTIONS CONTINUED

CAUTION: Your Aqua Ultraviolet unit is not submersible. If this unit falls into the water, turn main power off and then retrieve it. Do not attempt to use this sterilizer if it has been submerged. Do not operate this unit if it has a damaged cord or plug, if it is malfunctioning or if it has been dropped or been damaged in any manner.

HINT: The UV should be installed after the filter on the return line. This ensures the water is clear of debris and impurities that could inhibit the disinfection process. The UV can be installed before the filter, however, it will take longer to initially clear the water.

NOTE: It is suggested to install a flow switch (that can be purchased through your dealer) before any SL Series UV Sterilizer as a added protection against damage due to overheating.

2. WATER LINE CONNECTION: Installation of the sterilizer can be done in a few simple steps.

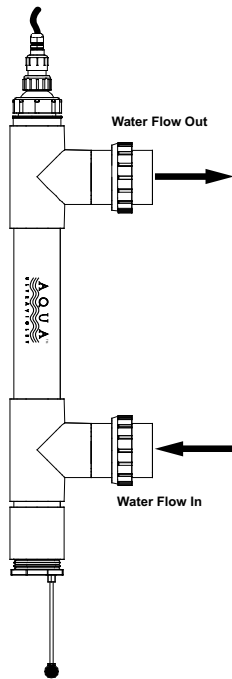

- Attach unions with PVC glue to the unit by cutting 2-3 1/4" pieces of pipe.
- The inlet and outlet connection should be as close to the filter as possible on the return line.
- Based on your personal plumbing configuration, additional plumbing supplies may be needed.
- Make sure the unit is mounted securely before operating. Make sure to leave enough room to pull the wiper rod all the way out.

CAUTION: DO NOT REDUCE THE SIZE OF THE INLET/ OUTLET, THIS UNIT MUST HAVE WATER FLOWING THROUGH IT AND THE CHAMBER MUST BE FULL OR IT WILL BURN UP. THIS PROBLEM IS NOT COVERED UNDER WARRANTY AND YOU WILL NEED TO PURCHASE A NEW UNIT!

Please go to our web site at
www.aquauv.com for the
"Installing a multiple housing unit video".

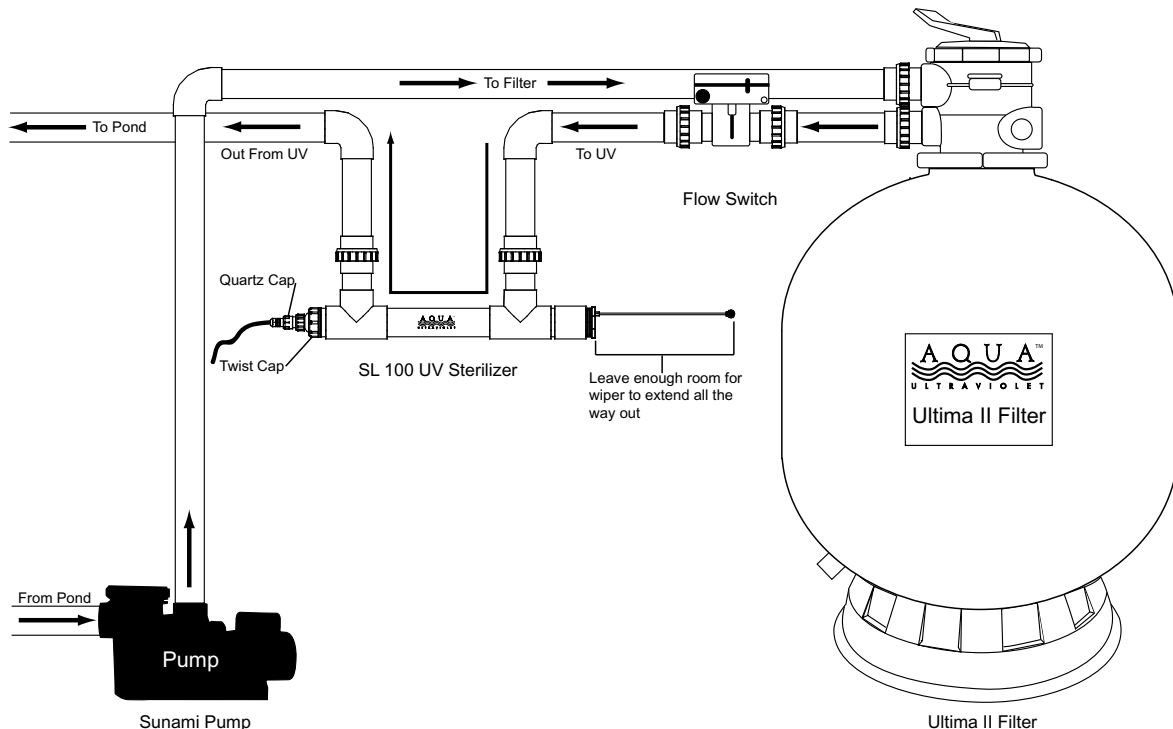

HOUSING INSTALLATION INSTRUCTIONS CONTINUED

3. INSTALLATION TESTING: Do not install lamp or electrical components yet. After all the connections have been made turn pump on and run it for five minutes to check for leaks.

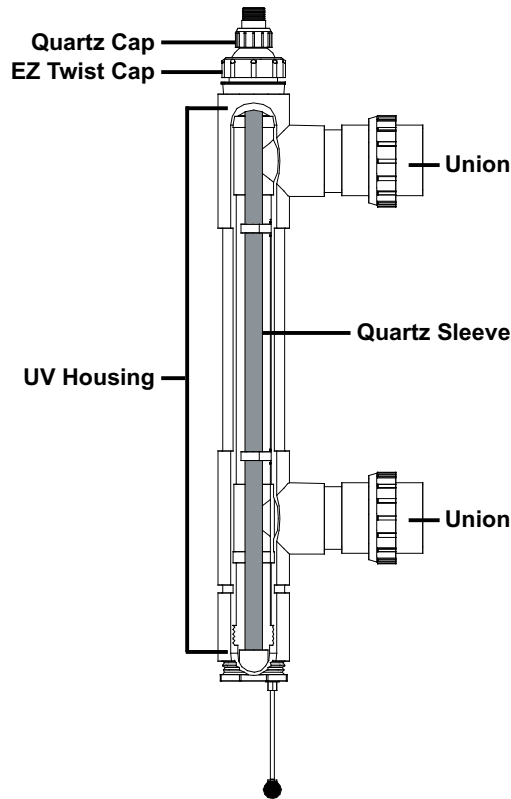

- A. If there are no leaks, turn pump off and continue to the **ELECTRICAL INSTALLATION** on page 14.
- B. If unit leaks turn pump off and continue.

B1. If you notice a leak from between the quartz cap and the EZ Twist Cap.

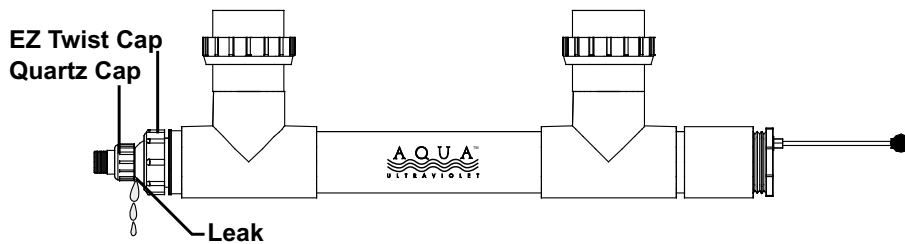

Undo quartz cap and push rubber seal into the housing evenly. The rubber seal should be 1/2 in and 1/2 out and the rubber seal bushing should sit on the top of the seal. Redo quartz cap and finger tighten. Do not use a pipe wrench, pliers or any other tool. Hand-tighten only.

Repeat step # 3

B2. If you notice a leak from between the EZ Twist cap and housing.

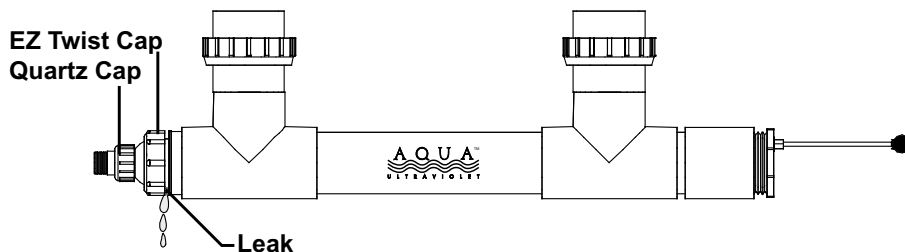

Untwist and check that the O-ring is seated in the top of the EZ-Twist cap. Hand-tighten until leak stops. Do not use a pipe wrench, pliers or any other tool. Hand-tighten only.

Repeat step # 3

HOUSING INSTALLATION INSTRUCTIONS CONTINUED

B3. If you notice a leak from the quartz sleeve.

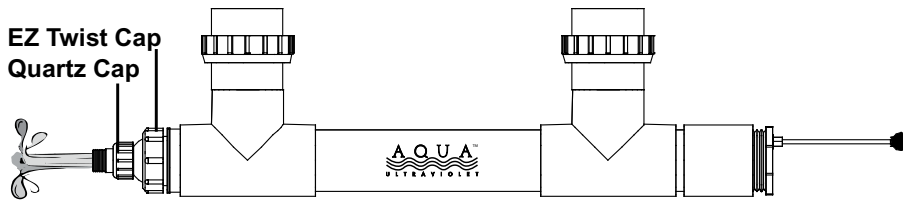

The quartz sleeve is broken and needs to be replaced. A broken quartz sleeve is not, nor is any damage caused as a result of a broken quartz sleeve, covered under warranty. Contact your dealer for a replacement. (See **INSTALLING A REPLACEMENT QUARTZ SLEEVE** on page 20).

B4. If you notice a leak from the base of the unit and the nut.

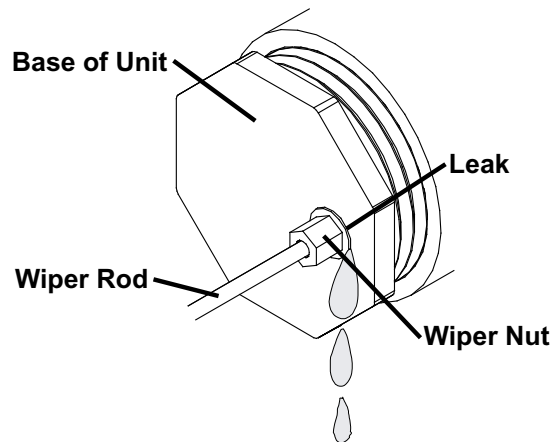

If you notice a leak between the base of the unit and the nut, the wiper nut may need more Teflon tape for a tighter seal. If the leak persists, please contact our customer service department for assistance.

B5. If you notice a leak from the wiper nut and the wiper rod.

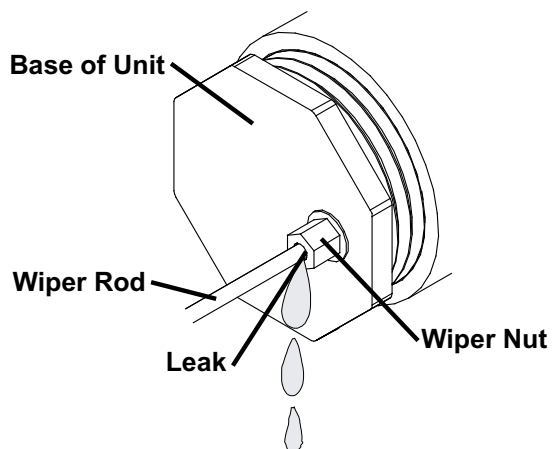

If you notice a leak between the wiper nut and the wiper rod, the wiper seal may be cracked or damaged. If this occurs, please contact our customer service department for assistance.

WARNING: DO NOT CONTINUE UNTIL YOUR INSTALLATION PASSES STEP #3

ELECTRICAL INSTALLATION

1. COVER REMOVAL: Remove the cover from the transformer box to allow access to screw holes located on the back panel of the box. The cover slides down.

2. MOUNTING: Mount the transformer vertically on to a wall or other vertical firm surface a minimum of 4' away from dwelling. Make sure the transformer is close enough to attach to the UV unit.

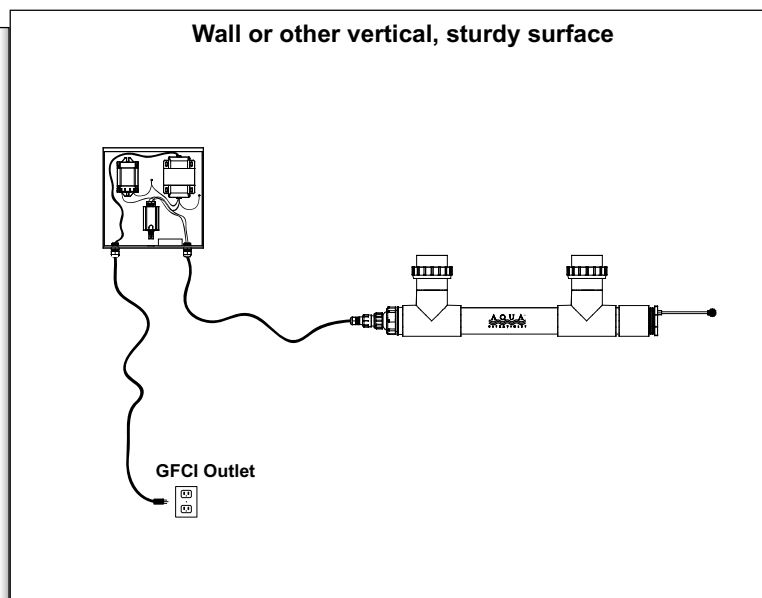

3. CONNECT THE LAMP: Plug the lamp into the clip connectors located at the end of the harness. Make sure the lamp is plugged in all the way and flush with the clip connectors. Insert the lamp into the quartz sleeve.

NOTE: Prevent finger marks on the lamp. If you touch the lamp use denatured alcohol and a soft cloth to clean the lamp.

NOTE: Lamps and quartz sleeves should be handled with care. Lamps and quartz sleeves are not warranted against breakage and damage.

Be careful when installing the lamp. If the lamp is not plugged in all the way this may cause damage to the unit and is not covered under warranty, nor is any other damage caused by improper installation.

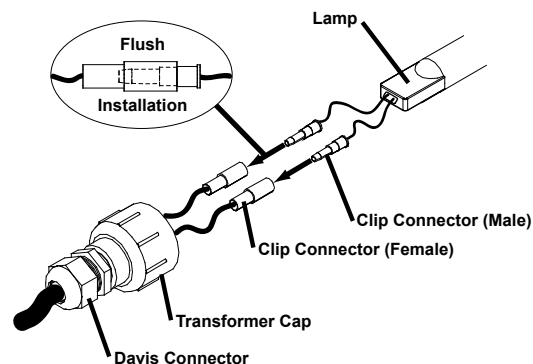

In a vertical installation, do not drop the lamp into the sterilizer or it will break the lamp and or the quartz sleeve.

In a horizontal (or vertical) installation, do not install the lamp at an angle (even a slight angle); this may cause a "U" shaped crack at the end of the quartz sleeve, or possible breakage of the lamp. If this should happen, do not proceed with the installation. Purchase a new quartz sleeve or lamp from your dealer and refer to the proper installation instructions.

Do not force the lamp into the quartz sleeve; any force would be an indication of an improper installation.

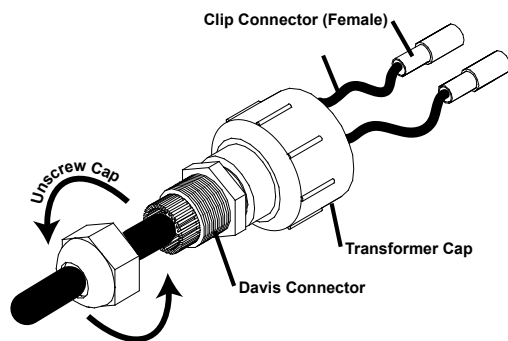

4. DISCONNECT THE DAVIS CONNECTOR: Unscrew the Davis connector located just above the transformer cap. This will allow the transformer cap to turn without kinking the wire.

WARNING: This unit creates and intense heat and can severely burn you. It is a water cooled unit and must cool down for AT LEAST 30 minutes before removing/ touching the lamp.

ELECTRICAL INSTALLATION CONTINUED

5. CONNECT THE TRANSFORMER CAP: Twist on transformer cap. Do not over tighten. This is a connection only and is not in contact with water so it does not have to be tight. Do not use a pipe wrench, pliers or any other tool.

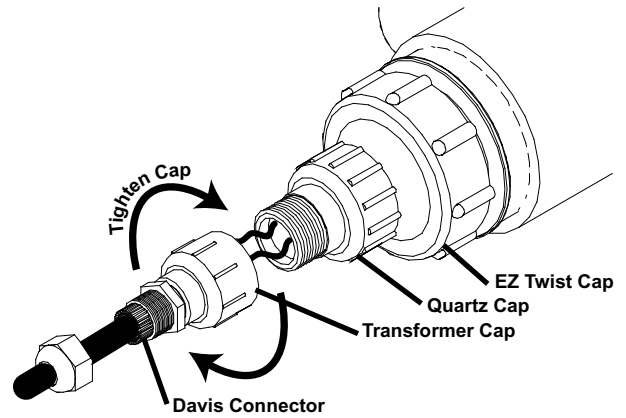

6. RECONNECT THE DAVIS CONNECTOR: Screw the Davis connector located just above the transformer cap back in.

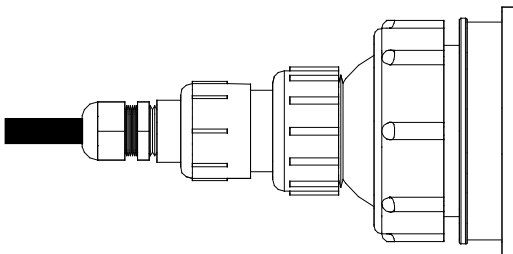

Completed assembly looks like this.

7. FINAL LEAK CHECK: Do not plug the sterilizer into power yet, turn on pump and check for leaks again. For illustrations **SEE PAGES 12 and 13.**

- a. If there are no leaks, continue with electrical installation.
- b. If you have a leak, return to INSTALLATION INSTRUCTIONS on pages 12-13. Carefully examine this unit after installation. This unit should not be plugged in if there are any leaks on any part of this unit.

8. GFCI CHECK: If the unit is not plugged into the GFCI (Ground Fault Circuit Interrupter) the warranty is void. A surge suppressor should be added for extra protection, it is not needed, but recommended.

NOTE: Your Aqua Ultraviolet sterilizer has been fitted with a clear transformer cap that will glow to indicate the lamp is on. This glow may not always be visible during daylight hours, please check at night. If the glow is not visible, please contact our customer service department.

CAUTION: Do not look at or handle UV lamps when lit outside of the housing. Considerable Ultraviolet energy is emitted which may produce severe sunburn and/or conjunctivitis with exposure to the direct UV light. As long as the UV light is in its housing it is 100% safe to humans and fish.

NOTE: The average life expectancy of Aqua Ultraviolet lamps is 14 months, if unit is in continuous operation. After 14 months the lamp may still light, but the UV has diminished.

NOTE: We recommend that the UV sterilizer be used in continuous operation for 24 hours per day, 7 days a week. Frequent starts and stops may shorten the life of your lamps.

SUGGESTION: If you are using any medication, we recommend shutting down the sterilizer as the UV radiation may affect the treatment.

CAUTION: Do not use the Aqua Ultraviolet sterilizer for anything other than its intended use.

MAINTENANCE

CAUTION: Always unplug the unit from electricity before disconnecting or installing any parts, or before cleaning.

WINTER:

If you are going to continually run water through your pond during freezing temperatures be sure to remove the Quartz Sleeve and Lamp and store safely indoors. An optional winterized cap can be purchased from your dealer. The Nema transformer may be left outside.

If you are not flowing water through your system and have a winterized cap, drain the unit completely and take the internal parts inside. If the unit is not completely drained, the water will freeze and crack the housing. This is not covered under warranty.

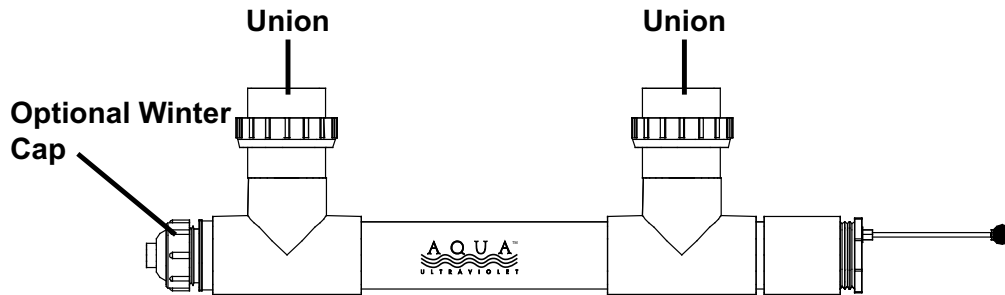

Take these parts inside

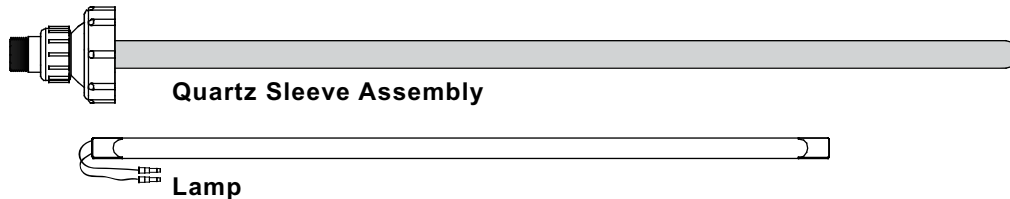

If you don't have a winterized cap or you are not going to continually run water through the system, disconnect unions and take the sterilizer inside.

Before re-installing the unit, the seals (Rubber Seal Bushing, Rubber Seal, and EZ-Twist O-ring) will need to be replaced and the quartz sleeve will need to be cleaned (see **INSTALLING THE QUARTZ SLEEVE** on page 20).

WARNING: Do not allow unit to be exposed to freezing temperatures, severe damage and/or breakage to the unit, and/or quartz sleeve may result and is not covered under warranty.

WARNING:

This unit creates an intense heat touching the lamp can severely burn you. The unit must cool down for AT LEAST 30 minutes before removing or touching the lamp.

CHANGING THE LAMP

Lamps should be changed after 14 months of continuous use.

NOTE: Use of anything other than Genuine Aqua Ultraviolet lamps voids the warranty

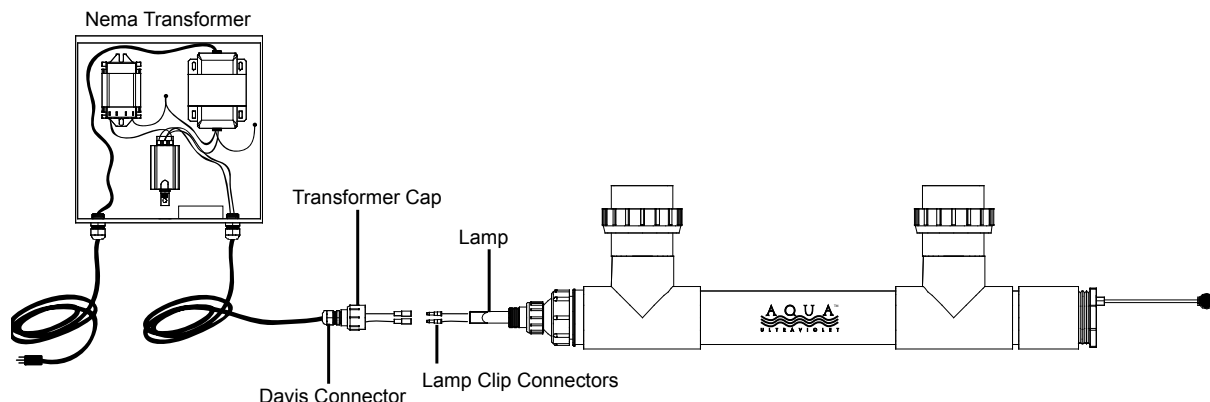

1. DISCONNECT THE UNIT: Unplug the unit.

2. DISCONNECT THE TRANSFORMER CAP: Twist the transformer cap off. Loosen the Davis connector first. For more details, **SEE INSTRUCTIONS # 5 on page 15.**

3. REMOVE LAMP: Slide lamp out while still connected to the transformer be careful not to slide the lamp out at an angle (even a slight angle) this may cause a "U" shaped crack at the end of the quartz sleeve, or possible breakage of the lamp.

NOTE: Do not force the lamp out of the quartz sleeve; any force would be an indication of an improper removal of the lamp.

NOTE: Check the rubber seal, rubber seal bushing and the quartz sleeve at every lamp change. If there are any leaks one or all of these items need to be replaced.

4. NEW LAMP INSTALLATION: When installing the new lamp refer to **ELECTRICAL INSTALLATION INSTRUCTIONS** on page 14 or see our video at www.aquaultraviolet.com

WIPER MAINTENANCE

NOTE: The wiper rod should be pulled at least once a week, the pump does not need to be turned off.

REPLACING THE WIPER BLADES

It is recommended that the wiper blades be replaced every time you change your lamp. Also, when reinstalling the sterilizer after winter.

1. DISCONNECT POWER: Unplug the unit and turn off the pump.

2. DISCONNECT TRANSFORMER

3. REMOVE LAMP: Slide the lamp out while still connected to the transformer. Be careful not to slide the lamp out at an angle, even a slight angle, this may cause a "U" shaped crack at the end of the Quartz Sleeve or possibly break the lamp. **Do not force the lamp out of the Quartz Sleeve, any force would be an indication of an improper removal of the lamp!!**

4. REMOVE WATER: Drain the housing.

Pull the wiper rod completely out (fully extended).

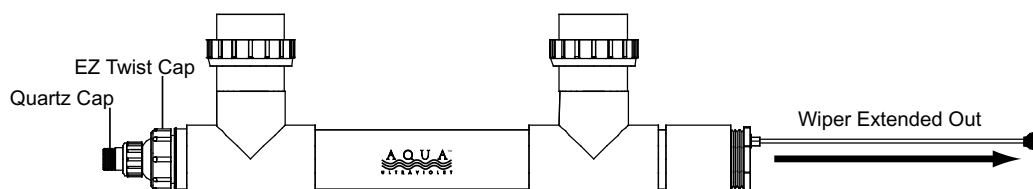

WIPER MAINTENANCE CONTINUED

5. DISCONNECT CAP: Twist off the large cap (EZ twist top) this will release the Quartz Sleeve and the assembly will still be intact.

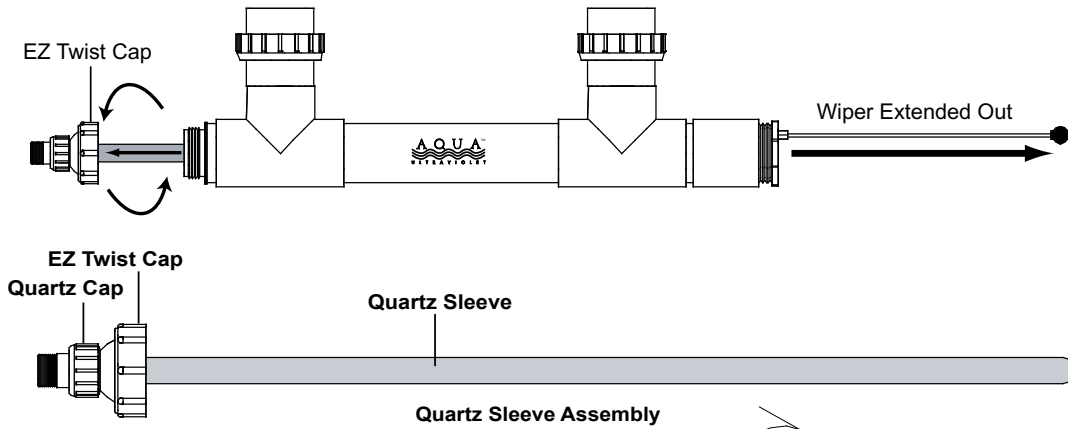

6. REMOVE PARTS: Unscrew the wiper ball and remove the hex nut.

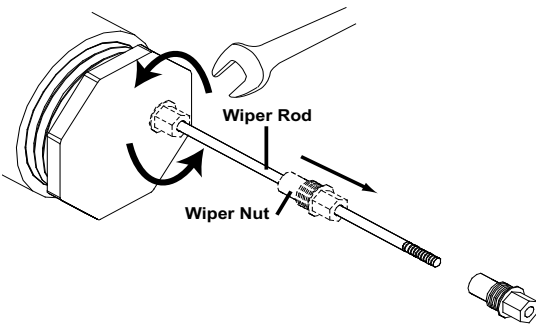
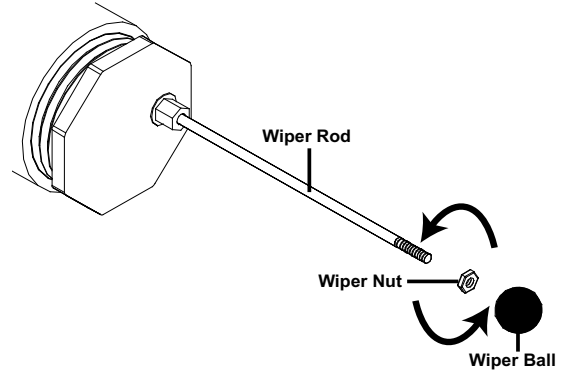

7. REMOVE WIPER NUT: Using a 1/2" wrench, unscrew and remove the wiper nut located at the base of the nut.

8. EXTRACT ROD: Pull the wiper rod from the large open end of the unit.

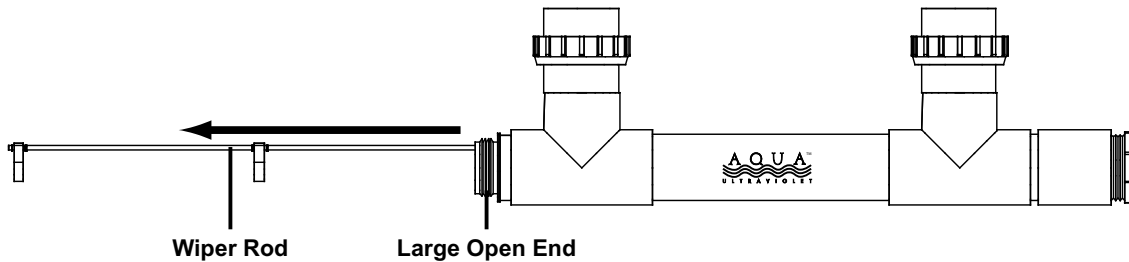

9. REMOVE TOP C-CLIP: Using needle nose pliers, remove top C-Clip from wiper rod. This will release the wiper blade.

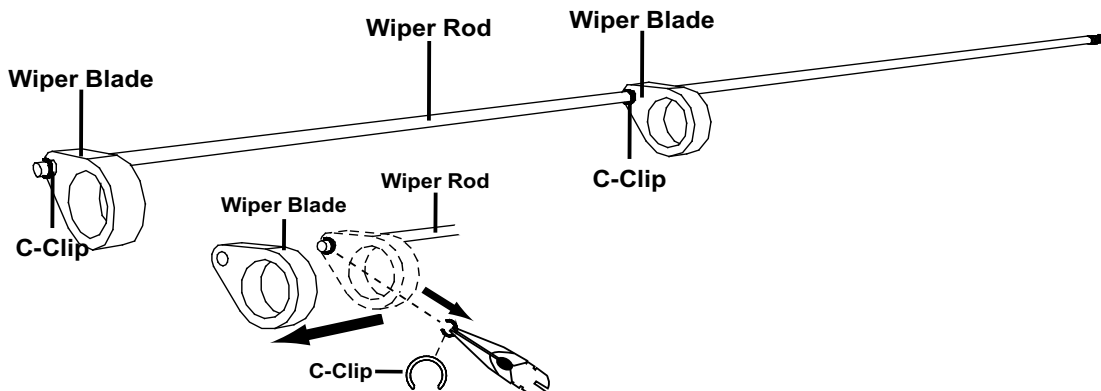

WIPER MAINTENANCE CONTINUED

10. RELEASE BLADE: Remove and replace wiper blade.

11. REPLACE C-CLIP: Using needle nose pliers replace the top c-clip into the top notch on the rod. Make sure the blade is secure. **Do not use the same c-clip or it will fall off.**

12. REINSTALL ROD ASSEMBLY: Insert rod assembly back in through the large open end of the unit (from which it was removed) and guide rod out through hole at the base of the unit.

13. INSTALL WIPER NUT: Screw new wiper nut in over the threads at the end of the rod and slide it the rest of the way down, until the nut is resting on the base of the unit. **NOTE:** Make sure to **SCREW** the nut over the threads on the rod or the seal inside of the wiper nut can be compromised causing the unit to leak

14. CONNECT ROD: Using a 1/2" wrench screw the nut into the base of the unit. Be careful not to cross thread.

15. REINSTALL PARTS: Re-install hex nut and wiper ball on the end of the rod.

16. MOISTEN ELEMENTS: Wet wiper blade and outside of quartz sleeve.

17. COMPRESS ROD: Push rod completely into the unit and insert Quartz Sleeve assembly through the blade. **PLEASE NOTE:** Units have 2 wiper blades, be sure to insert in both blades. Make sure Quartz Sleeve is inserted in the seat at the bottom of the unit. Tighten EZ twist cap.

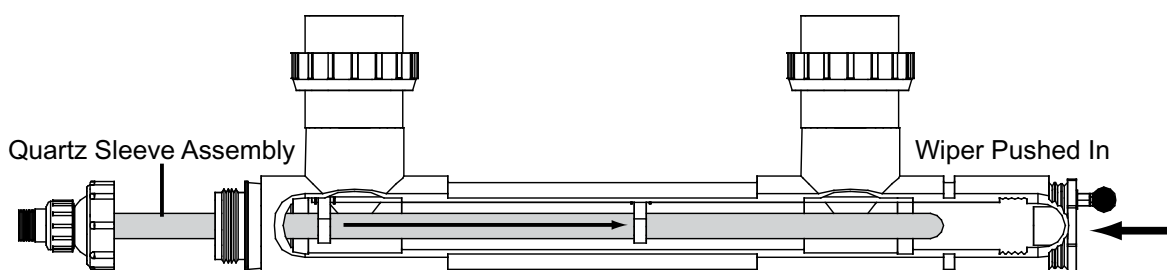
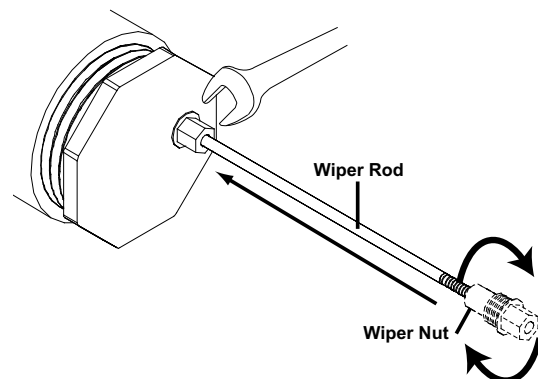

CLEANING THE QUARTZ SLEEVE

NOTE: If the wiper is used regularly, your quartz sleeve will need little or no extra cleaning. However certain metals may adhere to the quartz sleeve. These metals can not be removed by the wiper.

If Your Quartz Sleeve Needs Cleaning:

1. Unplug the unit, turn the pump off.
2. Twist the transformer cap off. Loosen the Davis connector first.
3. Slide lamp out while still connected to the transformer be careful not to slide the lamp out at an angle (even a slight angle) this may cause a "U" shaped crack at the end of the quartz sleeve, or possible breakage of the lamp.

Do not force the lamp out of the quartz sleeve. Any force would be an indication of an improper removal of the lamp.

4. Drain the housing.
5. On units with the wiper option pull the wiper rod completely out (fully extended).

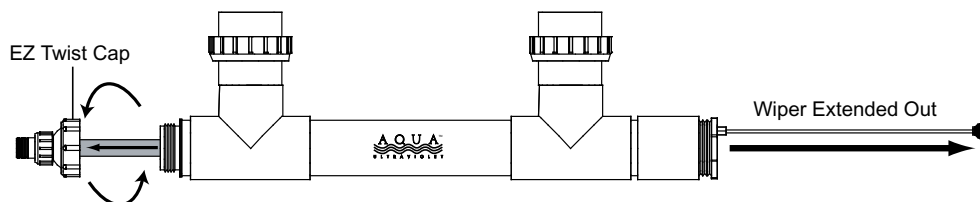

CLEANING THE QUARTZ SLEEVE CONTINUED

6. Twist off the large nut (EZ Twist Top). This will release the Quartz Sleeve and the assembly will still be intact.

7. Once the Quartz Sleeve assembly is removed, you will need to clean it with lime away, clr or similar products.

NOTE: Do not use any type of abrasive substance on the quartz sleeve as it may scratch the quartz.

8. For units with the wiper option wet the wiper blade and the quartz sleeve before reinstalling the sleeve into the unit. Push the rod completely into the unit and insert quartz sleeve assembly through the blade.

9. For all units slide the quartz sleeve back into the housing, be sure it is centered into the seat at the bottom of the housing.

10. Tighten EZ Twist Top

INSTALLING A REPLACEMENT QUARTZ SLEEVE:

Please go to our web site at

www.aquauv.com for the

“Replacing a Quartz Sleeve Video”.

1. Unplug system, turn pump off, and drain housing.

2. Untwist E-Z twist top.

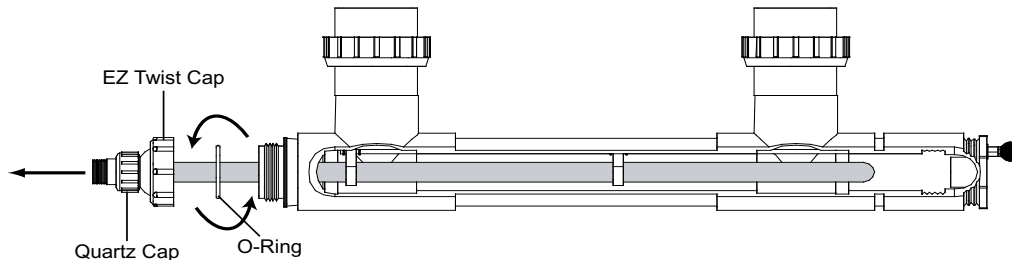

3. Untwist Quartz Cap. Push quartz sleeve up through E-Z Twist Top.

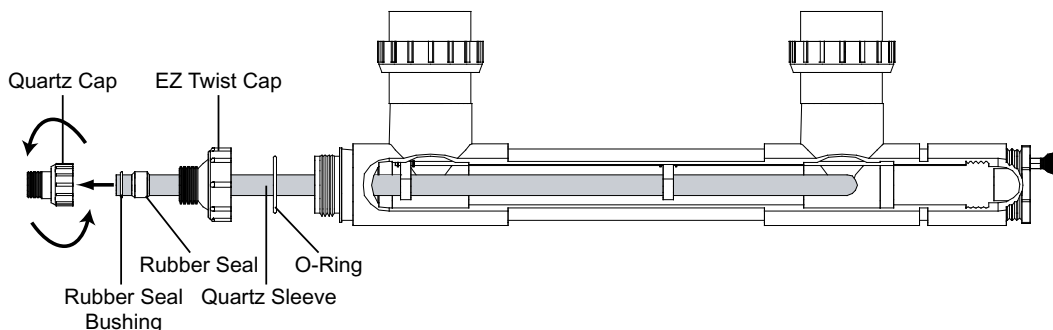

4. Discard broken quartz sleeve and rubber seal.

5. Re-install E-Z twist top without quartz sleeve. Slide quartz sleeve in housing with rubber seal already on quartz sleeve. Be sure to center the quartz sleeve into the seat at the bottom of the unit.

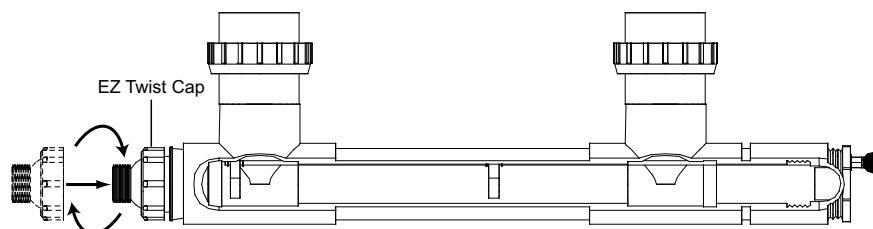

INSTALLING A REPLACEMENT QUARTZ SLEEVE CONTINUED

6. Gently push quartz sleeve and rubber seal in to E-Z twist top until 1/2 the rubber seal is showing equally around the quartz sleeve.

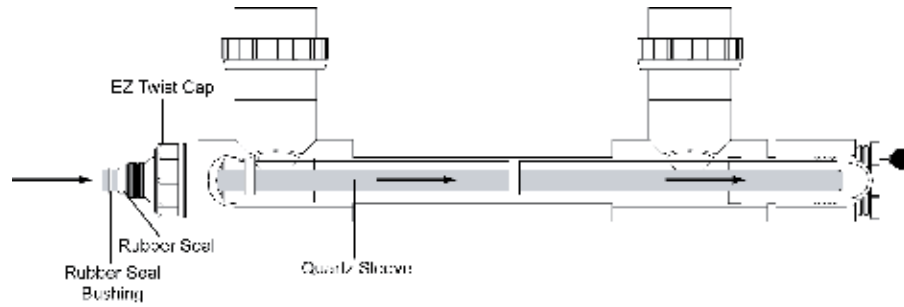

7. Twist on the Quartz cap. DO NOT use a pipe wrench, pliers or any other tool on this unit. Tighten by hand only.

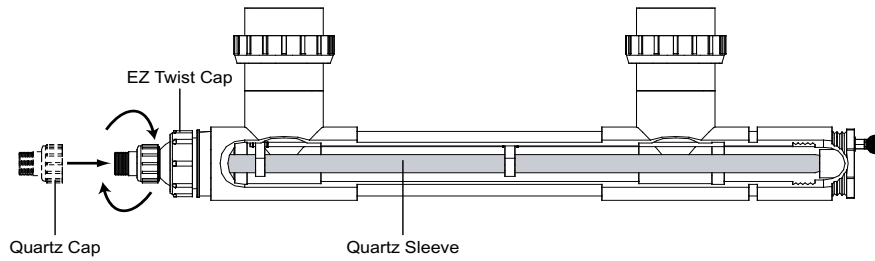

THIS SECTION CAN BE USED FOR NOTES:

INCORRECT INSTALLATIONS

The following will damage the unit's electrical components and/or quartz sleeve.

Incorrect Installation
EZ Twist Cap Over Rubber Seal

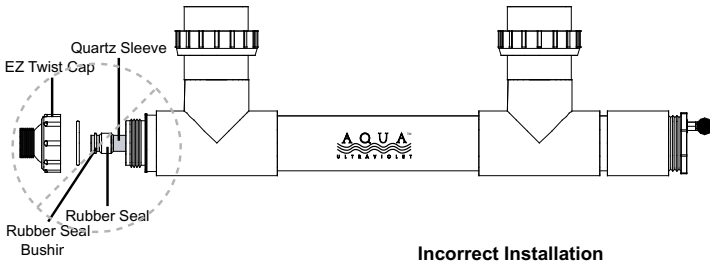

Incorrect Installation
Rubber Seal Is outside Of Quartz Cap

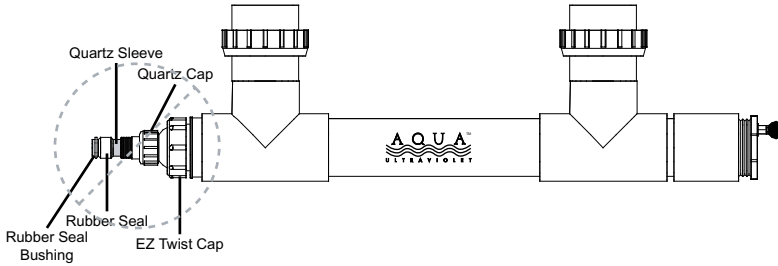

Incorrect Installation
Quartz Sleeve NOT Seated

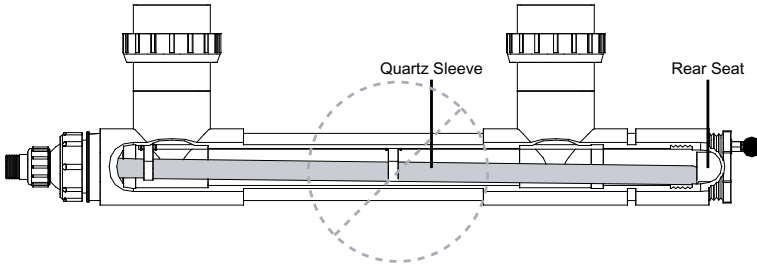

Incorrect Installation
Lamp At An Angle Will Create A U-Shaped Crack In the Quartz Sleeve

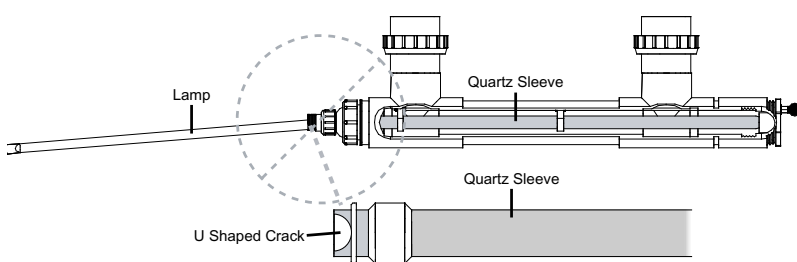

Incorrect Installation
One Blade Over the Quartz Sleeve and One Blade Outside of the Quartz Sleeve

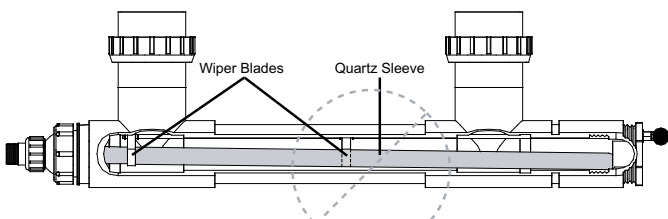

Incorrect Installation
Lamp Clip Connectors not Plugged
Flush with Harness Clip Connectors

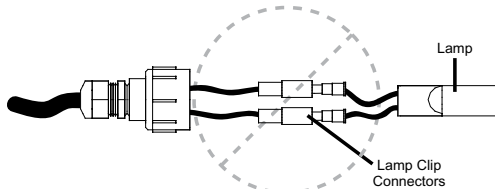

Correct Installation
Lamp Clip Connectors Pushed Completely
into Harness Clip Connectors

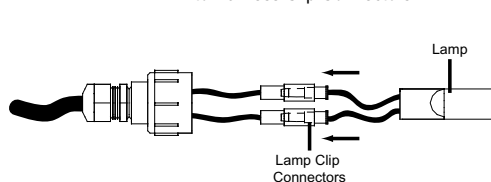

Incorrect Installation
Lamp Dropped in Quartz Sleeve Can
Cause Breakage

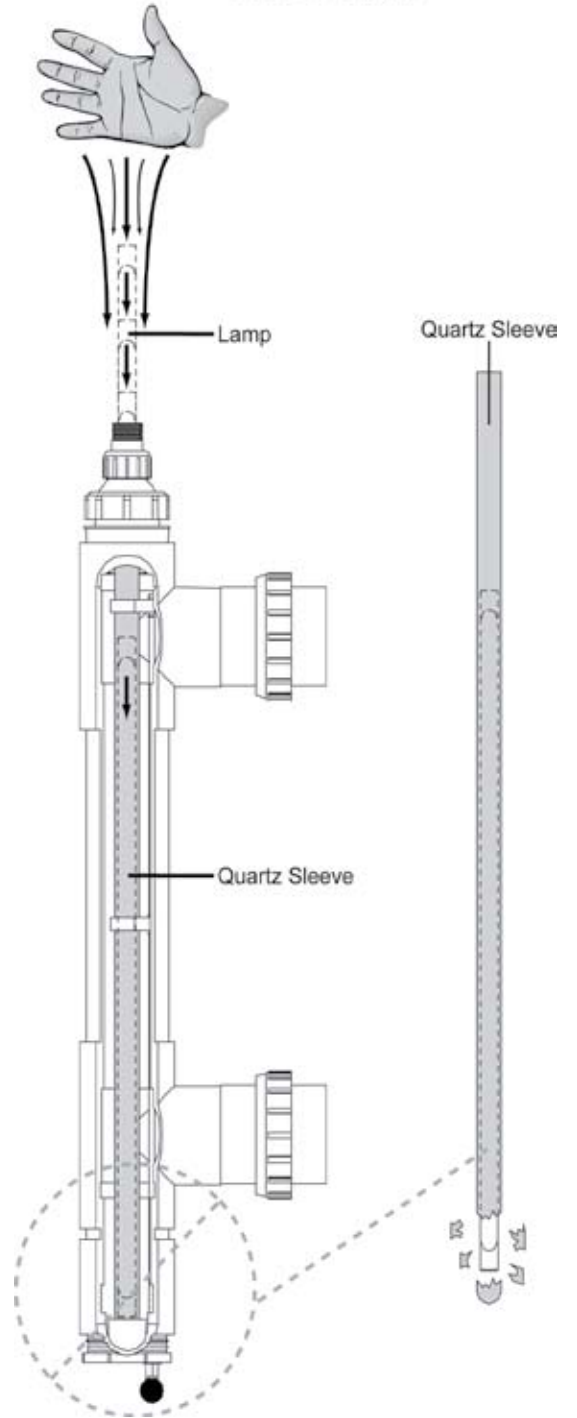

THIS SECTION CAN BE USED FOR NOTES:

