

STEEL METER DIVING STANDS

1/2 METER

3/4 METER

1 METER

70-209-501 (8' BOARD)
70-209-502 (10' BOARD)

70-209-510 (10' BOARD)
70-209-512 (12' BOARD)

70-209-520 (10' BOARD)
70-209-522 (12' BOARD)



CAUTION

ALL MINIMUM WATER ENVELOPE DIMENSIONS FOR RESIDENTIAL INGROUND SWIMMING POOLS MUST MEET THE ANSI/APSP/ICC-5 2011 AMERICAN NATIONAL STANDARD FOR RESIDENTIAL INGROUND SWIMMING POOLS (REFERENCED THROUGHOUT THESE ASSEMBLY AND INSTALLATION INSTRUCTIONS AS "ANSI/APSP/ICC-5 2011"). ALL WATER ENVELOPE DIMENSIONS FOR PUBLIC SWIMMING POOLS MUST MEET THE ANSI/NSPI-1 2003 STANDARD FOR PUBLIC SWIMMING POOLS (REFERENCED THROUGHOUT THESE ASSEMBLY AND INSTALLATION INSTRUCTIONS AS "ANSI/NSPI-1 2003"). COMPLY WITH LOCAL GOVERNMENT REGULATIONS IF THEY EXCEED ANSI/APSP/ICC OR ANSI/NSPI STANDARDS.

All diving boards and related equipment are manufactured for swimming pools ONLY. The S.R. Smith Steel Meter Diving Stands are designed to be easily transported and installed. Follow all instructions carefully and inspect closely to assure proper and safe installation.

PROPER INSTALLATION CANNOT BE OVERSTATED. IMPROPER INSTALLATION VOIDS S.R. SMITH'S WARRANTY AND MAY AFFECT THE SAFETY OF THE USER.

ASSEMBLY AND INSTALLATION INSTRUCTIONS – PLEASE READ CAREFULLY –



"Quality that is BUILT-IN, not ADDED-ON"

WESTERN SALES AND MANUFACTURING PLANT CORPORATE HEADQUARTERS

P.O. Box 400 • 1017 S.W. Berg Parkway
Canby, Oregon 97013
Phone (503) 266-2231 • Fax (503) 266-4334

EASTERN MANUFACTURING PLANT

105 Challenger Drive
Portland, Tennessee 37148
Phone (615) 325-0770 • Fax (615) 325-0775



www.srsmith.com

ATTENTION!

THESE INSTRUCTIONS MUST REMAIN WITH STAND OWNER

STEEL METER DIVING STAND

1/2 - 3/4 - 1 METER STANDS

8', 10' & 12' DIVING BOARDS W/ RESIDENTIAL MOUNTING KIT

S.R. SMITH CANNOT DESIGN OR GUARANTEE CUSTOMER'S CONCRETE, DIMENSIONALLY OR STRENGTHWISE. CONCRETE SLAB MUST BE ABLE TO WITHSTAND 800 LBS. APPLIED VERTICALLY 6" FROM TOE END OF BOARD AND COMPLY WITH LOCAL GOVERNMENT CODES.

THICKNESS: 6" MIN.
WIDTH: 4' MIN.

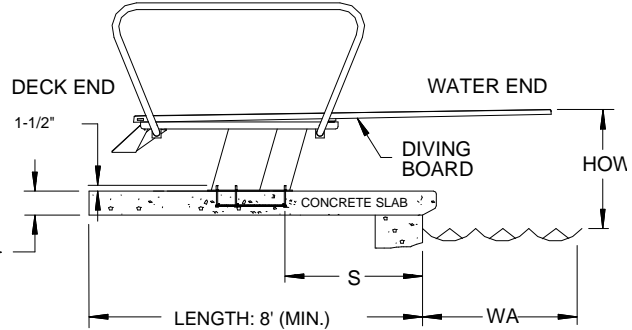

FIG. 1

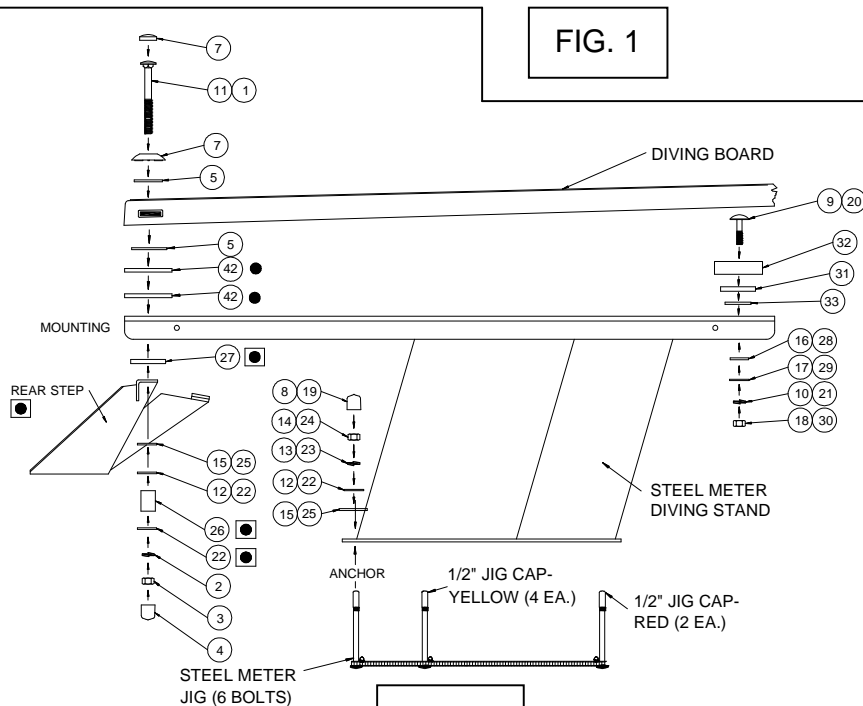

FIG. 2

RESIDENTIAL MOUNTING KIT (67-209-911-SS)

1. 1/2" X 4-1/2" CARRIAGE BOLT-S/S (2 EA.)
2. 1/2" LOCK WASHER S/S (2 EA.)
3. 1/2" HEX NUT S/S (2 EA.)
4. 1/2" PLASTIC NUT CAP (2 EA.)
5. 1/2" X 2" BLACK RUBBER MOUNTING WASHER (4 EA.)
6. 1/2" X 2" FLAT WASHER S/S (2 EA.)
7. WHITE PLASTIC RECESSED MOUNTING WASHER ASSY (2 EA.)

1/2 METER BOLT KIT (71-209-542-SS)

8. 1/2" PLASTIC NUT CAP (6 EA.)
9. 3/8" X 2" STEP BOLT S/S (2 EA.)
10. 3/8" LOCK WASHER S/S (2 EA.)
11. 1/2" X 3-1/2" CARRIAGE BOLT S/S (2 EA.)
12. 1/2" X 1-3/8" FLAT WASHER S/S (8 EA.)
13. 1/2" LOCK WASHER S/S (6 EA.)
14. 1/2" HEX NUT S/S (6 EA.)
15. 1/2" X 1-1/2" ROUND NYLON WASHER (8 EA.)
16. 3/8" X 7/8" NYLON PROTECTIVE WASHER (2 EA.)
17. 3/8" X 1" FLAT WASHER S/S (2 EA.)
18. 3/8" HEX NUT S/S (2 EA.)

3/4 & 1 METER BOLT KIT (71-209-543-SS)

19. 1/2" PLASTIC NUT CAP (6 EA.)
20. 3/8" X 2" STEP BOLT S/S (2 EA.)
21. 3/8" LOCK WASHER S/S (2 EA.)
22. 1/2" X 1-3/8" FLAT WASHER S/S (10 EA.)
23. 1/2" LOCK WASHER S/S (6 EA.)
24. 1/2" HEX NUT S/S (6 EA.)
25. 1/2" X 1-1/2" ROUND NYLON WASHER (8 EA.)
26. 1" SPACER SCHEDULE 40 PIPE S/S (2 EA.)
27. 15" RUBBER PAD (1 EA.)
28. 3/8" X 7/8" NYLON PROTECTIVE WASHER (2 EA.)
29. 3/8" X 1" FLAT WASHER S/S (2 EA.)
30. 3/8" HEX NUT S/S (2 EA.)

METER FULCRUM KIT (71-209-544)

31. 18" METER FULCRUM PLATE (1 EA.)
32. 18" METER FULCRUM PAD (1 EA.)
33. 20" RUBBER MOUNTING PAD (1 EA.)

- NOTES: ● USED ONLY WHEN INSTALLING HANDRAILS
 ● USED ONLY ON 3/4 AND 1 METER STANDS
 PARTS WITH TWO BUBBLES:
 LEFT IS FOR 1/2 METER
 RIGHT IS FOR 3/4 & 1 METER

STEEL METER DIVING STAND

1/2 - 3/4 - 1 METER STANDS

8', 10' & 12' DIVING BOARDS W/ COMMERCIAL MOUNTING KIT

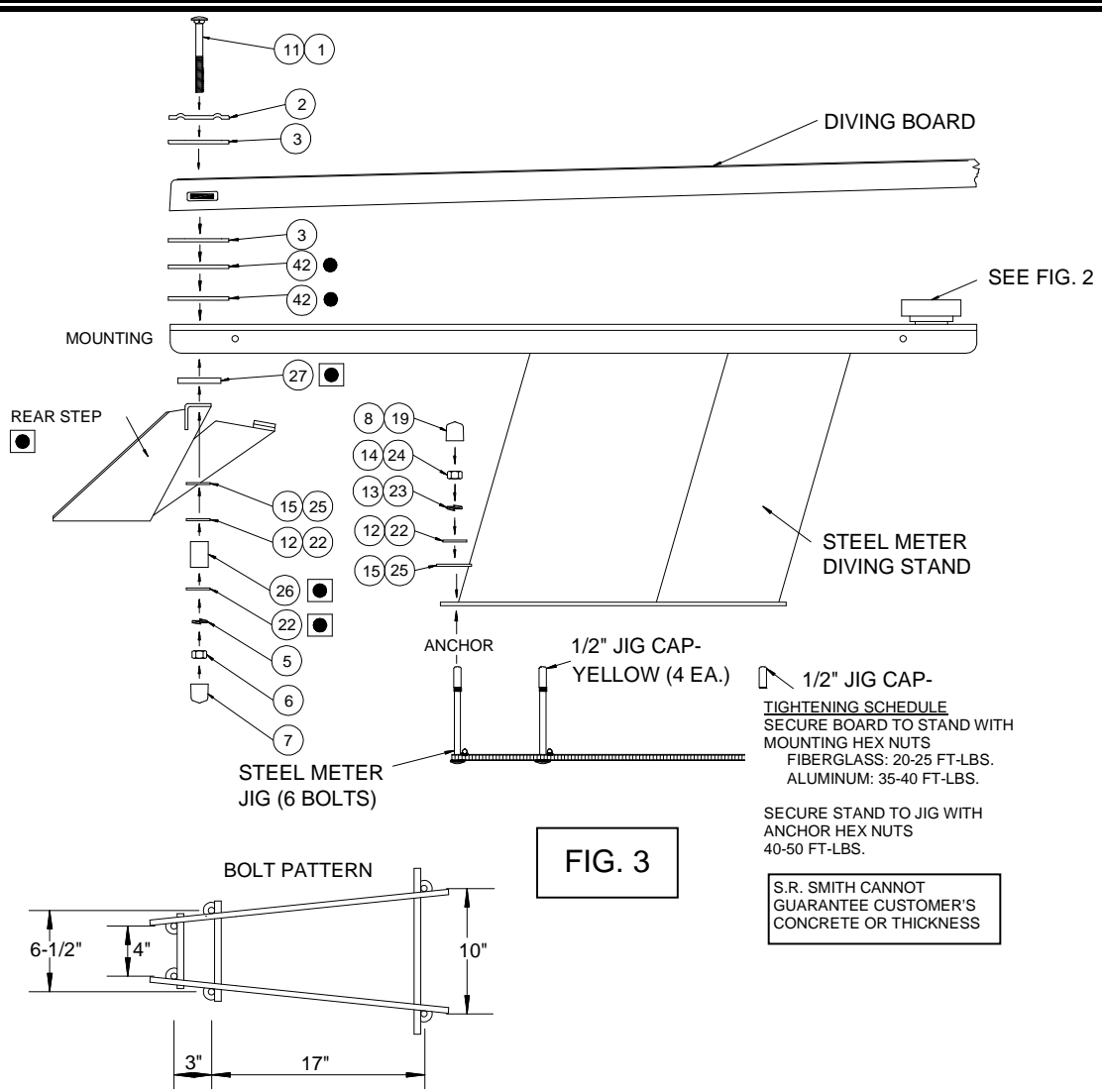
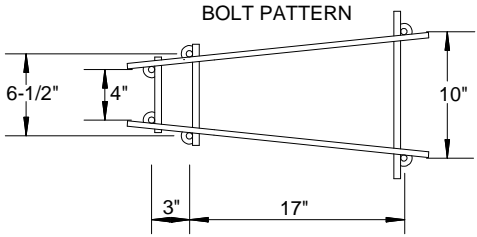

FIG. 3

TIGHTENING SCHEDULE
 SECURE BOARD TO STAND WITH MOUNTING HEX NUTS
 FIBERGLASS: 20-25 FT-LBS.
 ALUMINUM: 35-40 FT-LBS.

SECURE STAND TO JIG WITH ANCHOR HEX NUTS
 40-50 FT-LBS.

S.R. SMITH CANNOT GUARANTEE CUSTOMER'S CONCRETE OR THICKNESS



- 18" COMMERCIAL MOUNTING KIT (67-209-903-SS)**
1. 1/2" X 5" CARRIAGE BOLT S/S (2 EA.)
 2. 18" TOP MOUNTING PLATE (1 EA.)
 3. 18" RUBBER MOUNTING PAD (2 EA.)
 4. 18" BOTTOM MOUNTING PLATE (1 EA.) DO NOT USE
 5. 1/2" LOCK WASHER S/S (2 EA.)
 6. 1/2" HEX NUT S/S (2 EA.)
 7. 1/2" PLASTIC NUT CAP (2 EA.)

- 1/2 METER BOLT KIT (71-209-542-SS)**
8. 1/2" PLASTIC NUT CAP (6 EA.)
 9. 3/8" X 2" STEP BOLT S/S (2 EA.)
 10. 3/8" LOCK WASHER S/S (2 EA.)
 11. 1/2" X 3-1/2" CARRIAGE BOLT S/S (2 EA.)
 12. 1/2" X 1-3/8" FLAT WASHER S/S (8 EA.)
 13. 1/2" LOCK WASHER S/S (6 EA.)
 14. 1/2" HEX NUT S/S (6 EA.)
 15. 1/2" X 1-1/2" ROUND NYLON WASHER (8 EA.)
 16. 3/8" X 7/8" NYLON PROTECTIVE WASHER (2 EA.)
 17. 3/8" X 1" FLAT WASHER S/S (2 EA.)
 18. 3/8" HEX NUT S/S (2 EA.)

- 3/4 & 1 METER BOLT KIT (71-209-543-SS)**
19. 1/2" PLASTIC NUT CAP (6 EA.)
 20. 3/8" X 2" STEP BOLT S/S (2 EA.)
 21. 3/8" LOCK WASHER S/S (2 EA.)
 22. 1/2" X 1-3/8" FLAT WASHER S/S (10 EA.)
 23. 1/2" LOCK WASHER S/S (6 EA.)
 24. 1/2" HEX NUT S/S (6 EA.)
 25. 1/2" X 1-1/2" ROUND NYLON WASHER (8 EA.)
 26. 1" SPACER SCHEDULE 40 PIPE S/S (2 EA.)
 27. 15" RUBBER PAD (1 EA.)
 28. 3/8" X 7/8" NYLON PROTECTIVE WASHER (2 EA.)
 29. 3/8" X 1" FLAT WASHER S/S (2 EA.)
 30. 3/8" HEX NUT S/S (2 EA.)

NOTES:
 ● USED ONLY WHEN INSTALLING HANDRAILS
 ● USED ONLY ON 3/4 AND 1 METER STANDS
 PARTS WITH TWO BUBBLES:
 LEFT IS FOR 1/2 METER
 RIGHT IS FOR 3/4 & 1 METER

STEEL METER DIVING STAND HANDRAILS

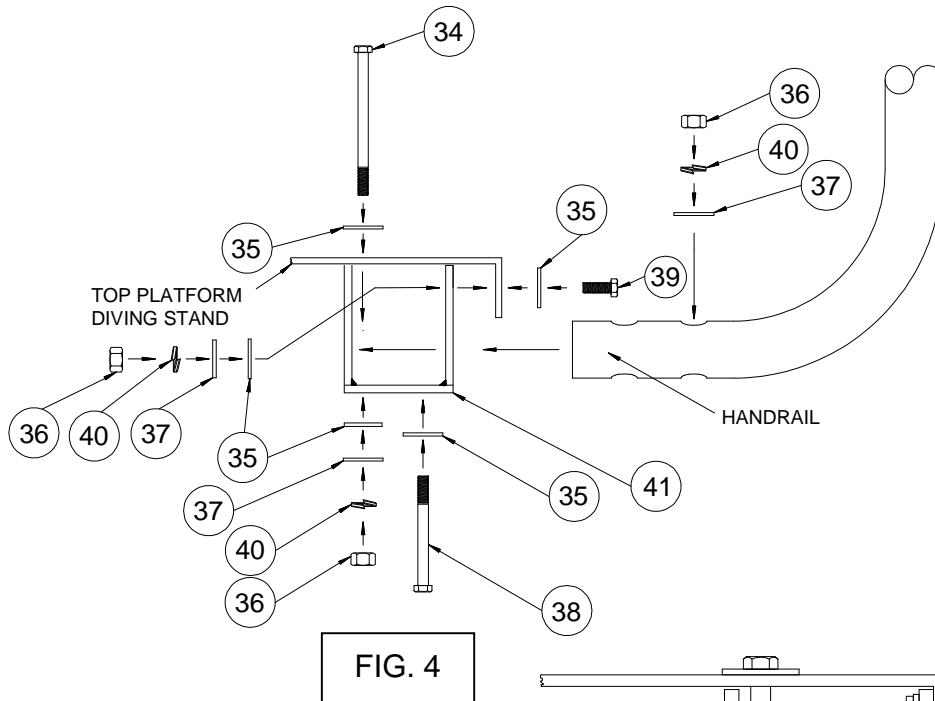
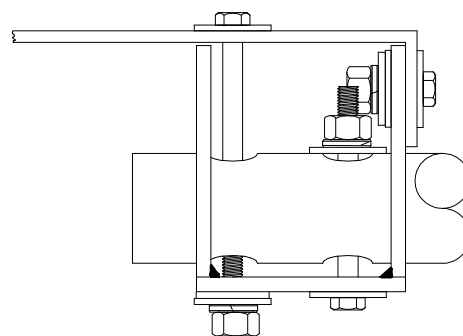

FIG. 4

METER HANDRAIL BOLT KIT (71-209-561-SS)

- 34. 3/8" X 5-1/2" HEX BOLT S/S (4 EA.)
- 35. 3/8" X 7/8" NYLON PROTECTIVE WASHER (20 EA.)
- 36. 3/8" HEX NUT S/S (12 EA.)
- 37. 3/8" X 1" FLAT WASHER S/S (12 EA.)
- 38. 3/8" X 3" HEX BOLT S/S (4 EA.)
- 39. 3/8" X 1" HEX BOLT S/S (4 EA.)
- 40. 3/8" LOCK WASHER S/S (12 EA.)
- 41. HANDRAIL BRACKET ASSY (4 EA.)
- 42. 18" RUBBER MOUNTING PAD (2 EA.)



ASSEMBLED

FIG. 5

INSTALLATION INSTRUCTIONS

HANDRAILS ARE OPTIONAL ON ALL 1/2 & 3/4 METER STANDS
 HANDRAILS ARE REQUIRED ON ALL 1 METER STANDS

1. Bolt the handrail bracket assemblies on the inside of the stand top platform as show in Fig.3 for each of the four locations.
2. Insert the end of the handrail into the bracket through the holes so the holes line up with the bracket bolt holes.
3. Secure hex nut with 40 - 50 ft-lbs.
4. When installing or reinstalling diving board after handrails have been installed on diving stand, be sure to use the two 18" Rubber Mounting Pads (#42) between bottom of diving board and top of stand (See Fig.2 or 3). This shims the board up so that it will not hit the 3/8" X 5-1/2" Hex Bolt and damage the bottom of the board.

STEEL METER DIVING STAND INSTALLATION CHART RESIDENTIAL POOLS

FOR PUBLIC POOLS SEE PAGE 7

Refer to Fig.1

Model	Diving Board Length	ANSI/APSP/ICC-5 2011 Pool Type	Distance For Setting Front Bolt of Jig From Water's Edge "S"	Min. Overhang ± 3"	Max. Height of Board Above Water "HOW"
STEEL METER				"WA"	"HOW"
1/2 METER	8'	II	39"	18"	20"
1/2 METER	8'	III	33"	24"	26"
1/2 METER	10'	III	45"	24"	26"
1/2 METER	8'	IV	27"	30"	30"
1/2 METER	10'	IV	39"	30"	30"
3/4 METER	10'	IV	46"	30"	30"
1/2 METER	8'	V	21"	36"	40"
1/2 METER	10'	V	33"	36"	40"
3/4 METER	10'	V	40"	36"	40"
3/4 METER	12'	V	51"	36"	40"
1 METER	10'	V	43"	36"	40"
1 METER	12'	V	57"	36"	40"

IMPORTANT: The distance for setting the front bolt of the jig "S" from the water's edge is valid only if the minimum water depth is maintained at the tip of the board noted at point A in ANSI/APSP/ICC-5 2011, Figure 3 and Table 1. If minimum water depth is not maintained the distance "S" must be adjusted accordingly.

*WA DIMENSION IS VALID ONLY IN CONJUNCTION WITH MIN. DEPTH AT POINT A (SEE ANSI/APSP/ICC-5 2011 FIGURE 3 AND TABLE 1) FOR POOL TYPE.

NOTE: When coping is used do not set front bolt of jig closer than 3" from the back edge of coping.

INSTALLATION INSTRUCTIONS

BE SURE CONCRETE DECK SURROUNDING ANCHOR JIG COMPLIES WITH MINIMUM DIMENSIONS AS SHOWN IN FIG.1 FOR POOL TYPE AND BOARD TO BE USED.

1. READ CAREFULLY the following, and pages A through E, which have been extracted from ANSI/APSP/ICC-5 2011 and pay particular attention to Figure 3 and Table 1 set forth therein.
2. The Steel Meter six-bolt Jig should be set in accordance with the INSTALLATION CHART above and Fig.1, with the two "RED" capped bolts closest to the pool. This will give the desired minimum overhang. Board must be placed at deep end of pool on centerline.

CAUTION: Before pouring concrete around Jig, check the bolt pattern of Jig to Fig.3. It is possible that they have become misaligned through shipping and handling.

3. Make sure bolts project out of concrete 1-1/2" with ample concrete depth below Jig. Refer to Fig.1 for minimum deck thickness, width and length.
4. When finishing deck surface, maintain level deck where Jig bolts project out so that the stand makes uniform contact with deck surface.
5. Before mounting stand, chisel away any excess concrete that may have built up around Jig bolts and remove the red and yellow bolt caps
6. Place stand over Jig bolts and secure according to Fig.2 or 3, depending upon mounting kit used. Tighten ANCHOR hex nuts. TIGHTENING SCHEDULE on page 3 when tightening all MOUNTING and ANCHOR hex nuts.
7. With Steel Meter Stand properly secured, select board size according to Chart 1. The installation sequence is as follows:
 - (I) Meter Fulcrum (Fig.2)
 - (II) Handrails (Fig.4 on page 4)
 - (III) Rear Step and Board (Fig.2 on 3)
8. The Rear Step and Board may be installed with either the Residential Mounting Kit (Fig.2) or the Commercial Mounting Kit (Fig.3). Tighten MOUNTING hex nuts.

9. **IMPORTANT:** Refer to Table 2. Maximum diving board length, maximum height over water at point A and minimum cross section dimensions at point A and B shall be in accordance with Table 2 and Fig 3.

Table 2- S.R. Smith Residential Pool Specifications

Pool type	MAX. DIVING BOARD LENGTH	MAX. HEIGHT OVER WATER AT POINT A	CROSS SECTIONAL DIMENSIONS AT POINT A		CROSS SECTIONAL DIMENSIONS AT POINT B					
	DBL**	HOW**	F	G	H	J	K	L	M	N
0	DIVING EQUIPMENT IS PROHIBITED									
I	6' DB/6' JB	20"	2'-9"	5'-0"	4'-0"	7'-2 1/2"	7'-6"	6'-0"	3'-9"	2'-1 1/2"
II	8' DB/6' JB	20"	2'-9"	3'-10"	4'-2"	7'-2 1/2"	7'-6"	6'-8"	3'-9"	2'-1 1/2"
III	10' DB/8' JB	26"	2'-9"	4'-4 3/4"	4'-4 1/2"	7'-5 1/2"	8'-0"	6'-7"	3'-11 1/2"	1'-7 1/2"
IV	10' DB/8' JB	30"	2'-9"	5'-10 1/2"	3'-10"	7'-8"	8'-6"	8'-3"	5'-7"	2'-7"
V	12' DB/8' JB	40"	2'-9"	6'-2"	3'-11 1/2"	7'-9 1/2"	9'-0"	8'-2 1/2"	5'-9"	2'-1"

NOTES:

1. ABBREVIATIONS: DBL=Diving Board Length, DB=Diving Board, JB=Jump Board, HOW=Height Over Water.
2. IMPORTANT: The walls of a Type I Pool, when defining the Maximum Diving Water Envelope shall be plumb.
3. All dimensions are minimum, except where noted as maximum.
4. One half (1/2) the width shown at each point shall be available on each side of the diving equipment centerline.
5. Minimum water depth under tip of diving board (Point A) is important to maintain.

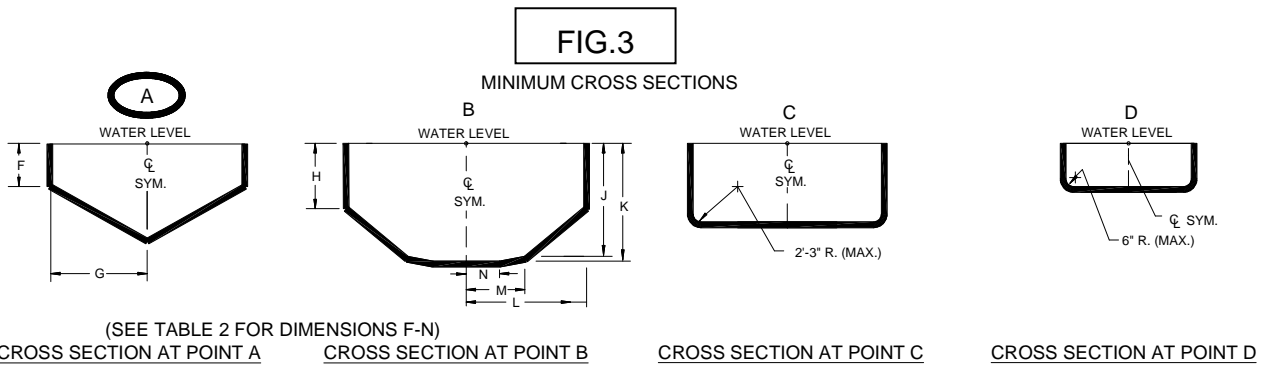

10. The top surface of the diving board from the deck end to the tip end shall be level or have an upward slope of 5/8" per foot (16 mm: 305mm) maximum. Elevation difference shall not exceed 6 inches (152mm) from the deck end to the tip of the board. There shall be no downward slope towards the water. The slope shall be measured using a level as shown in Fig. 4.

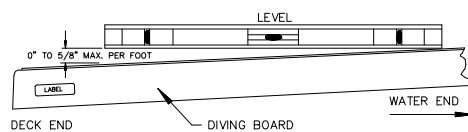

FIG.4

11. Minimum unobstructed headroom from the top of the manufactured diving equipment shall be provided for diving in accordance with Table 1.

Pool Type	Minimum Headroom Above Diving Surface
I	12 feet (3.7 m)
II	12 feet (3.7 m)
III	13 feet (4 m)
IV	13 feet (4 m)
V	14 feet (4.3 m)

STEEL METER DIVING STAND INSTALLATION CHART PUBLIC POOLS

FOR RESIDENTIAL
POOLS SEE PAGE 5

Refer to Fig.1

Model	Diving Board	ANSI/NSPI-1 2003 Pool Type	Distance For Setting Front Bolt of Jig From Water's Edge "S"	Min. Overhang + 3"	Max. Height of Board Above Water
STEEL METER	"DB"			"WA**"	"HOW"
1/2 METER	8'	VI	27"	30"	26"
1/2 METER	10'	VI	39"	30"	26"
1/2 METER	8'	VII	21"	36"	30"
1/2 METER	10'	VII	33"	36"	30"
3/4 METER	10'	VII	40"	36"	30"
3/4 METER	12'	VII	51"	36"	30"
1/2 METER	10'	VIII	21"	48"	40"
3/4 METER	10'	VIII	28"	48"	40"
3/4 METER	12'	VIII	39"	48"	40"
1 METER	10'	VIII	31"	48"	40"
1 METER	12'	VIII	45"	48"	40"
3/4 METER	12'	IX	15"	72"	120"
1 METER	12'	IX	21"	72"	120"

COMPLY WITH LOCAL GOVERNMENT REGULATIONS FOR PUBLIC SWIMMING POOLS IF THEY EXCEED THE ANSI/NSPI-1 STANDARD.

* L₁ DIMENSION IS VALID ONLY IN CONJUNCTION WITH D₁ DEPTH FOR TYPE POOL AND BOARD TO BE USED. L₁ IS WA IN FIG.1 AND INSTALLATION CHART.

NOTE: When coping is used do not set front bolt of jig closer than 3" from the back edge of coping.

INSTALLATION INSTRUCTIONS

BE SURE CONCRETE DECK SURROUNDING ANCHOR JIG COMPLIES WITH MINIMUM DIMENSIONS AS SHOWN IN FIG. 1 FOR POOL TYPE AND BOARD TO BE USED.

1. Carefully read pages F through I in this booklet, which contains the applicable articles of the ANSI/NSPI-1 2003 STANDARD FOR PUBLIC SWIMMING POOLS.
2. The Steel Meter six-bolt Jig should be set in accordance with the INSTALLATION CHART above and Fig.1, with the two " RED " capped bolts closest to the pool. This will give the desired minimum overhang. Board must be placed at deep end of pool on centerline.

CAUTION: Before pouring concrete around Jig, check the bolt pattern of Jig to Fig.3. It is possible that they have become misaligned through shipping and handling.

3. Make sure bolts project out of concrete 1-1/2" with ample concrete depth below Jig. Refer to Fig.1 for minimum deck thickness, width and length.
4. When finishing deck surface, maintain level deck where Jig bolts project out so that the stand makes uniform contact with deck surface.
5. Before mounting stand, chisel away any excess concrete that may have built up around Jig bolts and remove the red and yellow bolt caps
6. Place stand over Jig bolts and secure according to Fig.2 or 3, depending upon mounting kit used. Tighten ANCHOR hex nuts. TIGHTENING SCHEDULE on page 3 when tightening all MOUNTING and ANCHOR hex nuts.
7. With Steel Meter Stand properly secured, select board size according to Chart 1. The installation sequence is as follows:
 - (I) Meter Fulcrum (Fig.2)
 - (II) Handrails (Fig.4 on page 4)
 - (III) Rear Step and Board (Fig.2 or 3)
8. The Rear Step and Board may be installed with either the Residential Mounting Kit (Fig.2) or the Commercial Mounting Kit (Fig.3). Tighten MOUNTING hex nuts.

ONLY ONE PERSON ON A JUMP BOARD AT A TIME,
WITH A MAXIMUM WEIGHT OF 250 LBS.

ARTICLE 5 - POOL DIMENSIONS AND TOLERANCES
EXTRACTED FROM ANSI/APSP/ICC-5 2011
AMERICAN NATIONAL STANDARD FOR RESIDENTIAL INGROUND SWIMMING POOLS

5 Pool Dimensions and Tolerances

5.1 General requirements. Design dimensions shall comply with the specifications in this standard. The pool shall be constructed to these design dimensions within the tolerances listed in 5.1.1.

5.1.1 Construction tolerances. There shall be construction tolerances allowed on dimensional designs. The length, width, and depth shall be limited to a tolerance of plus or minus 3 in. (± 76 mm). All other dimensions shall be limited to a tolerance of ± 2 in. (± 51 mm), unless otherwise specified.

NOTE: Negative construction tolerances shall not be applied to the shallow area dimensions of the Minimum Diving Envelope given in Table 1, p. 4.

Figure 1 Maximum allowable wall slope

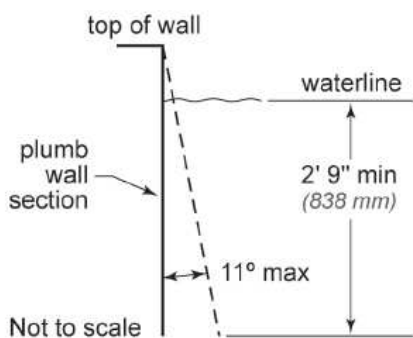

5.2 Perimeter shape. No limits are specified for shapes of pools. Consideration shall be given to circulation and safety to the user.

5.3 Walls—Requirements

5.3.1 Walls in the shallow area and deep area of the pool shall not slope greater than 11° (5:1 slope ratio) to a transition point of the floor (see Figure 1). The transition to the bottom of the pool between points D and E (see Figure 3, p. 5) shall not be less than 2 ft 3 in. (686 mm) below the waterline.

Figure 2 Typical pool design configurations

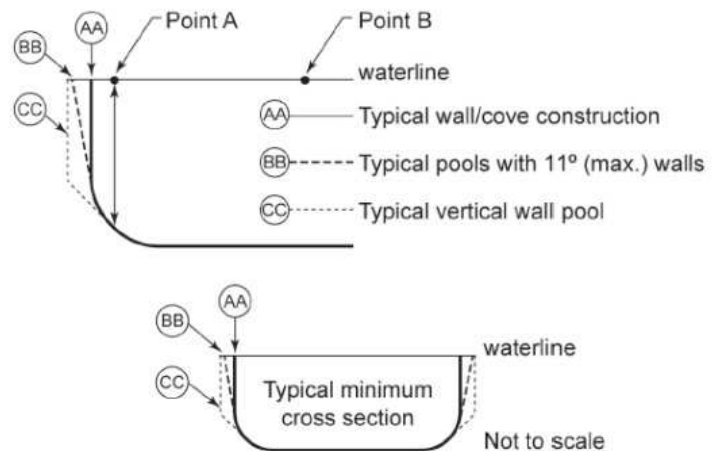

Figure 3 Minimum diving water envelope

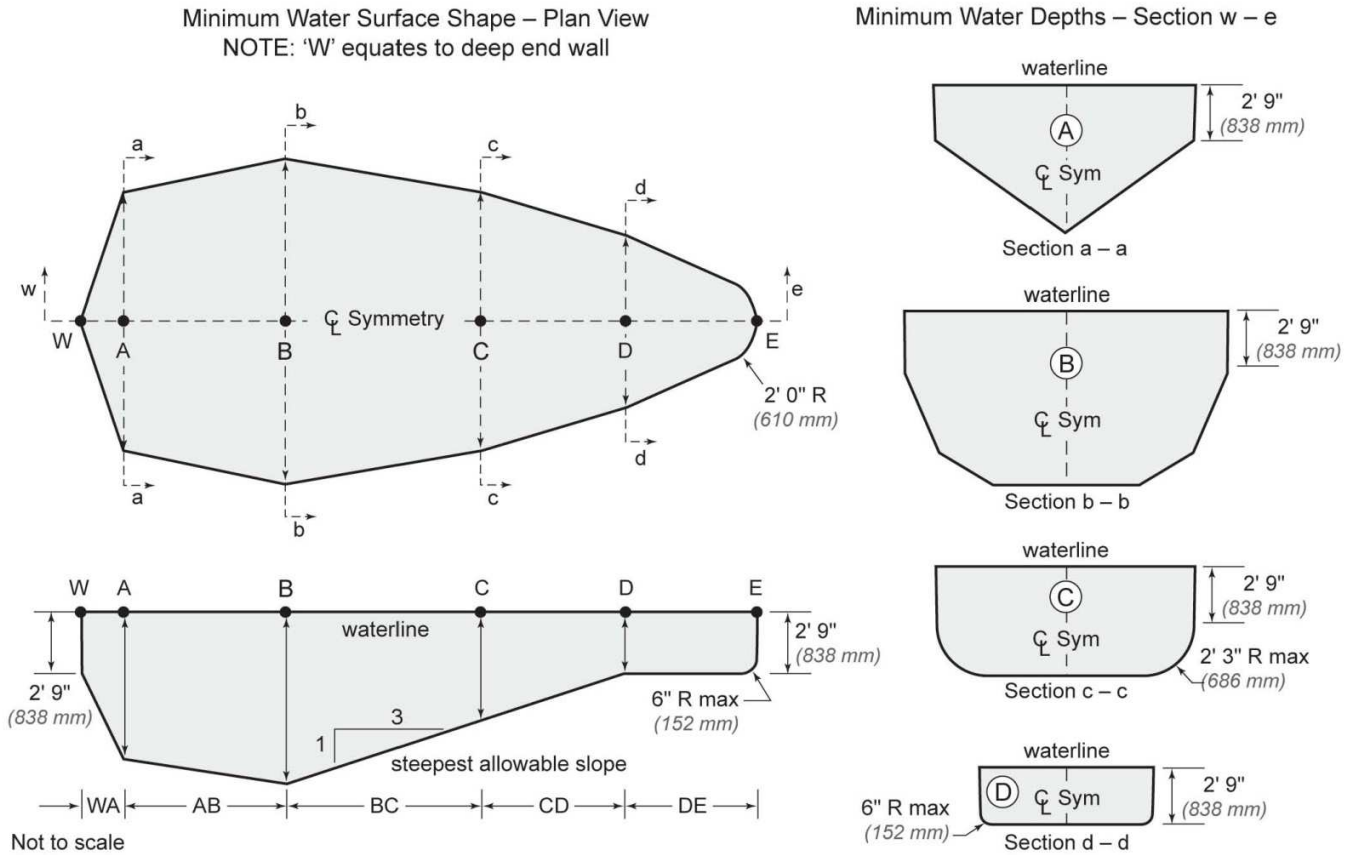

Table 1. Minimum diving water envelope for swimming pools designated types I-V

Pool Types	Minimum Depths at Point				Minimum Widths at Point				Minimum Lengths between Points					
	A	B	C	D	A	B	C	D	WA	AB	BC	CD	DE	WE
0	Manufactured diving equipment is prohibited													
1	6' 0" (1.82 m)	7' 6" (2.29 m)	5' 0" (1.52 m)	2' 9" (838 mm)	10' 0" (3.05 m)	12' 0" (3.66 m)	10' 0" (3.05 m)	8' 0" (2.44 m)	1' 6" (457 mm)	7' 0" (2.13 m)	7' 6" (2.29 m)	Varies	6' 0" (1.82 m)	28' 9" (8.76 m)
2	6' 0" (1.82 m)	7' 6" (2.29 m)	5' 0" (1.52 m)	2' 9" (838 mm)	12' 0" (3.66 m)	15' 0" (4.57 m)	12' 0" (3.66 m)	8' 0" (2.44 m)	1' 6" (457 mm)	7' 0" (2.13 m)	7' 6" (2.29 m)	Varies	6' 0" (1.82 m)	28' 9" (8.76 m)
3	6' 10" (2.08 m)	8' 0" (2.44 m)	5' 0" (1.52 m)	2' 9" (838 mm)	12' 0" (3.66 m)	15' 0" (4.57 m)	12' 0" (3.66 m)	8' 0" (2.44 m)	2' 0" (610 mm)	7' 6" (2.29 m)	9' 0" (2.74 m)	Varies	6' 0" (1.82 m)	31' 3" (9.53 m)
4	7' 8" (2.34 m)	8' 6" (2.59 m)	5' 0" (1.52 m)	2' 9" (838 mm)	15' 0" (4.57 m)	18' 0" (5.49 m)	15' 0" (4.57 m)	9' 0" (2.74 m)	2' 6" (762 mm)	8' 0" (2.44 m)	10' 6" (3.20 m)	Varies	6' 0" (1.82 m)	33' 9" (10.3 m)
5	8' 6" (2.59 m)	9' 0" (2.74 m)	5' 0" (1.52 m)	2' 9" (838 mm)	15' 0" (4.57 m)	18' 0" (5.49 m)	15' 0" (4.57 m)	9' 0" (2.74 m)	3' 0" (914 mm)	9' 0" (2.74 m)	12' 0" (3.66 m)	Varies	6' 0" (1.82 m)	36' 9" (11.2 m)

NOTES

1. Minimum length between points CD may vary based upon water depth at point D and the slope between points C and D.
2. Drawings are not to scale.
3. Negative construction tolerances (see para. 5.1.1) shall not be applied to any of the dimensions shown in the Minimum Water Envelopes given in Table 1.
4. Pool types designate minimum water envelope sizes as specified by the diving board manufacturers.

Figure 4 Offset ledges

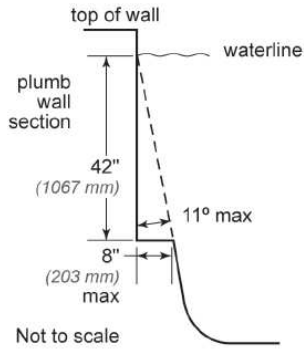

5.3.2 As shown in Figure 2, at the depths of (A) and (B), the walls are permitted to continue to join the floor.

5.4 Offset Ledges

5.4.1 Offset ledges shall be a maximum of 8 in. (203 mm) wide.

5.4.1.1 Offset ledges located less than 42 in. (1.07 m) below waterline shall be proportionately less than 8 in. (203 mm) wide and fall within 11° from plumb, measured from the top of the waterline (see Figure 4).

5.5 Floor slopes. Floor slopes shall be reasonably uniform and comply with paras. 5.5.1 through 5.5.3.

5.5.1 The slope of the floor from the shallow end wall towards the deep area shall not exceed a 1:7 incline to the point of the first slope change, if any (D–E) as shown in Figure 5.

5.5.2 Changes in slope between shallow and deep areas shall be at a minimum water depth of 2 ft 9 in. (838 mm) and be at least 6 ft (1.83 m) from the shallow end, except as specified in para. 6.3.

5.5.3 The slope of the floor shall not exceed a 1:3 incline under the lengths (B–D) of the Diving Envelope (see Figure 5).

5.6 Shallow end water depths. Water depth in the shallow area shall be a minimum of 2 ft 9 in. (838 mm), except for those locations specified in para. 6.3 “Shallow End Detail for Beach and Sloping Entries.”

5.7 Manufactured diving equipment for in-ground swimming pools (diving board/stand combination, manufactured platform, or field fabricated)

5.7.1 When manufactured or field fabricated diving equipment is installed, it shall conform to the specifications set forth in paras. 5.7–5.9. It shall be located in the deep area of the pool to provide the minimum dimensions as shown in para. 5.8, and shall be installed in accordance with manufacturer’s instructions.

Figure 5 Shallow end depths

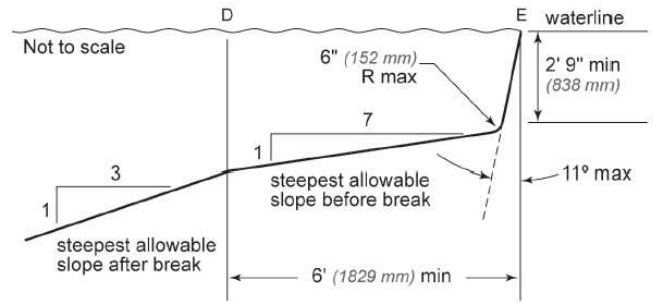

5.7.1.1 Manufactured or field fabricated diving equipment shall be located directly above Point A. Diving equipment shall not be installed on Type O pools (see Table 1).

5.7.1.2 Maximum elevation of a diving board above the water shall be in accordance with manufacturer’s installation instructions. Raised decking may be installed around the diving board up to level with the top of the board.

5.7.2 Manufactured diving equipment installation and use instructions shall be provided by the diving equipment manufacturer and shall specify the minimum water dimensions required for each diving board and diving stand combination. They shall refer to the diving envelope type of their choice by dimensionally relating their products to Point A on the diving envelopes as shown in Figure 3, Table 1, and paras. 5.8.1–5.8.3

5.7.2.2 Diving equipment shall be permanently labeled and affixed to the diving equipment or jump boards and include, but not be limited to the following:

- manufacturer’s diving equipment name and address
- date of manufacture
- minimum diving envelope
- maximum weight limitations.

5.7.2.3 Diving equipment shall have slip-resisting tread surfaces.

5.8 Figure 3 diagrams show dimension points referred to in Table 1.

5.8.1 Point A: Point A is the point from which all other forward dimensions of width, length, and depth are then established for the Minimum Diving Water Envelope. If the tip of the diving board or diving platform overhang is located at a distance of WA or greater from the deep end wall and the water depth at that location is equal to or greater than the water depth requirement at Point A (see Table 1), then the point on the water surface directly below the center of the tip of the diving

board or diving platform shall be identified as Point A.

5.8.1.2 Location of Point A: The minimum Diving Water Envelope dimensions for pools with manufactured diving equipment shall be taken from Point A as shown in Figure 3. Point A shall be defined as the point on the water surface where the water depth is required at Point A and is provided at a distance of WA as shown in Table 1 from the deep end wall. The center of the tip of the diving board, platforms, manufactured or field fabricated shall be located directly above Point A.

5.8.1.3 Point A as shown in Figure 3 and Table 1 shall be the reference point of origin for all dimensions defining the minimum diving envelope.

5.8.2 Type O pools (where diving is prohibited) shall not be limited in width, length, or water depth except as specifically provided for in this standard.

- Pool Type I 42 in. (1.07 m)
- Pool Type II 42 in. (1.07 m)
- Pool Type III 50 in. (1.27 m)
- Pool Type IV 60 in. (1.52 m)
- Pool Type V 69 in. (1.75 m).

5.8.3 Location of equipment and pool features in the minimum diving envelope. If the pool is designed for use with diving equipment, all steps, pool stairs, ladders, underwater benches, offset ledges special features and other accessory items or any parts thereof, these features shall be located outside the Minimum Diving Envelope (see Figure 6).

5.9 Stationary diving platform(s) and diving rock(s).

Stationary diving platform(s) and diving rock(s) built on site field fabricated shall be allowed to be flush with the wall and located in the diving area of the pool. Point A shall be in front of the wall at the platform or diving rock centerline. Diving rocks or platforms are prohibited on Pool Type O.

5.10 Stationary diving platform(s) and diving rock(s)

5.10.1 Stationary diving platform(s) and diving rock(s) shall not be permitted on Pool Type O.

5.10.2 The maximum height of the stationary diving platform or diving rock above the waterline shall be as follows:

- Pool Type I 42 in. (1.07 m)
- Pool Type II 42 in. (1.07 m)
- Pool Type III 50 in. (1.27 m)
- Pool Type IV 60 in. (1.52 m)
- Pool Type V 69 in. (1.75 m).

Figure 6 Top view examples of accessory equipment and pool features prohibited in the minimum diving envelope

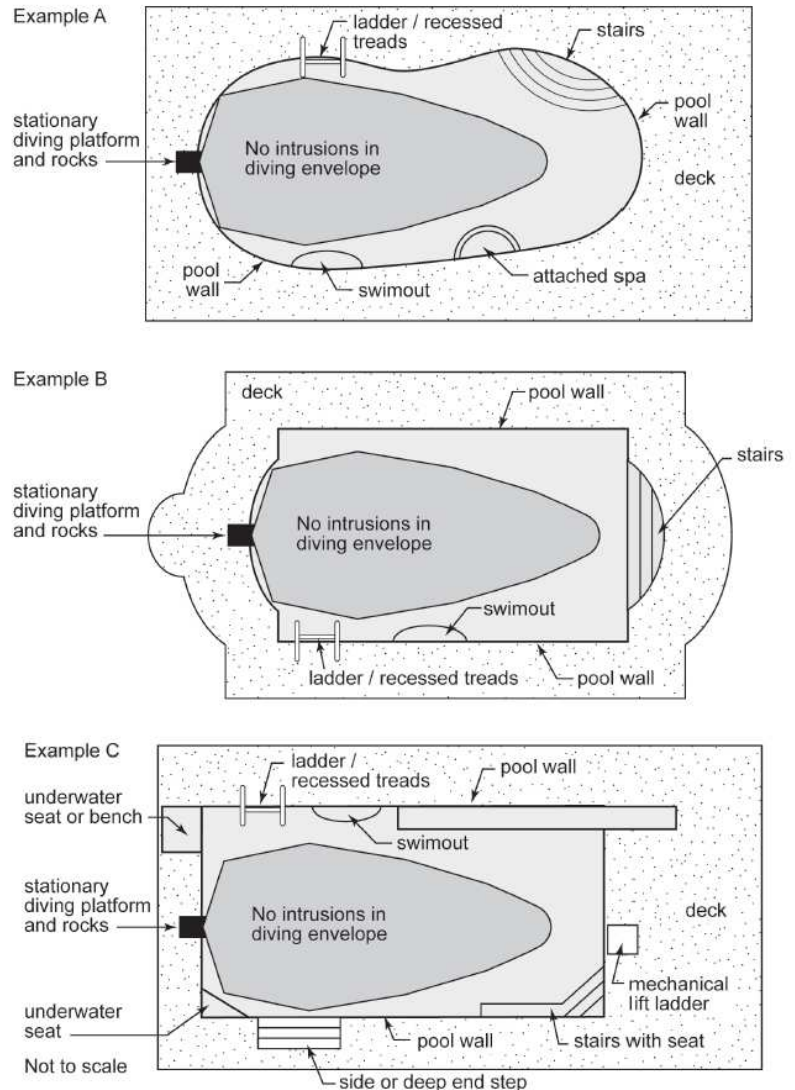

5.10.3 The diving equipment manufacturer shall specify minimum headroom above water.

5.11 Swimming pool slides

5.11.1 Slides, where installed, shall be installed in accordance with the manufacturer's specifications and comply with the U.S. Consumer Product Safety Commission (CPSC) *Standard for Swimming Pool Slides* as published in the *Code of Federal Regulations, 16 CFR Ch. II, Part 1207*.

5.11.2 Slides constructed on-site are not covered by this standard.

NOTE: For consumer safety information, warnings, and education programs, see Appendices F, G, and H.

Appendix F

Recommendations to Warn Against Shallow Water Diving

This appendix is not part of the American National Standard ANSI/APSP/ICC-5 2011. It is included for information only.

Recommended methods to warn against shallow water diving may include, but not be limited to:

A. Safety Signs

It is an open question before the Human Factors Society and others whether signage is an effective means that will modify human behavior to prevent accidents.

If warning signs are used to warn against shallow water diving, the signage should be in compliance with ANSI-Z535 1998 Series of standards for safety signs and colors or the latest revision.

This sign is based upon a study entitled "Design of Swimming Pool Warnings." This sign has been reviewed by the staff of the U.S. Consumer Product Safety Commission and supports its use.

B. Additional Signage Use

The ANSI-Z535 Series of Standards reflects the consensus of various experts on warning sign

Figure 8 Sign warning against shallow water diving



appearance and content. Signage, which is consistent with the ANSI-Z535 Standards, is permitted to be added to components, equipment, facilities, or installations, to provide additional information.

Manufacturers are permitted to either affix additional signage to their products or packaging, or to supply the signage with the product to be affixed at the time of installation.

Appendix G

Safety Considerations and Warning Recommendations

This appendix is not part of the American National Standard ANSI/APSP/ICC-5 2011. It is included for information only.

The Association of Pool & Spa Professionals (APSP) suggests that the builders/installers of swimming pools advise the initial owner/operator of a residential pool of the following:

Warning Recommendations: The APSP suggests the builder/installer advise the pool owner of the risk of drowning, especially for children under the age of five, and the risk of diving into shallow water in one or more of the following ways: verbally, through publications or signage. The following are suggested recommendations:

Lifesaving Equipment: The APSP suggests the builder/installer advise the pool owner/operator that basic lifesaving equipment including one or more of the following items should be on hand at all times:

- A light, strong, rigid pole not less than twelve feet (12', 3.7 m) long
- A minimum one fourth inch (6 mm) diameter throwing rope as long as one and one-half (1½) times the maximum width of the pool or 50 feet (15.2 m), whichever is less, which has been firmly attached to a Coast Guard-approved ring buoy having an outside diameter of approximately 15 in. (381 mm), or some other similar flotation device.

Safety Considerations for Pool Owner/Operators:

For additional safety information see www.APSP.org.

This standard does not replace good judgment and personal responsibility. In permitting use of the pool by others, owners/operators must consider the skill,

attitude, training, and experience of the expected user. It is the pool owner/operator's responsibility to learn, understand, and enforce these basic safety principles and rules:

- Encourage children to learn how to swim.
- Never allow diving, jumping or sliding into shallow water.
- Adequate adult supervision is required when the pool is in use.
- Adequate adult supervision is always required when children are present.
- Encourage parents to learn CPR.
- Encourage children to never swim alone.
- Keep all electrical radios, speakers and other appliances away from the swimming pool.
- Do not allow roughhousing and horseplay.
- Keep deck clean and clear of objects that may create a hazard.
- Keep all breakable objects out of the pool area.
- Alcohol consumption and pool activities do not mix. Never allow anyone to swim, dive or slide under the influence of alcohol or drugs.

Do's and Don'ts for Diving into swimming pools with manufactured diving equipment, diving rocks, and stationary diving platforms:

- Do know the shape of the pool bottom and the water depth before you dive or slide headfirst.
- Do plan your path to avoid submerged obstacles, surface objects, or other swimmers.
- Do hold your head up, arms up, and steer up with your hands.
- Do practice carefully before you dive or slide.
- Do test the diving board for its spring before using.
- Do remember that when you dive down, you must steer up.
- Do dive straight ahead, not off the side of the diving board.
- Don't drink and dive.
- Don't dive or slide headfirst in the shallow part of the pool.
- Don't dive from any place that is not specifically designed for diving.
- Don't ever dive head first into shallow water (5 feet or less).
- Don't dive across the narrow part of the pool.
- Don't run and dive.
- Don't dive from any place that is not specifically designed for diving.

- Don't engage in horseplay on diving or sliding equipment.
- Don't use diving equipment as a trampoline.
- Don't do a back dive.
- Don't try fancy dives; keep the dives simple.
- Don't dive or slide headfirst at or through objects such as inner tubes.
- Don't put diving or sliding equipment on a pool that wasn't designed for it.
- Don't swim or dive alone.
- Don't dive into unfamiliar bodies of water.

Rules for General Use of Swimming Pool Slides.*

Under all circumstances you should prohibit:

- All headfirst entry from slide.
- Horseplay.
- Any slide entries by non-swimmers into deep water, to protect them from drowning.
- Standing on the top of a slide or outside the guardrails.
- Jumping from a slide.
- Diving from a slide.
- Sliding into areas with submerged obstacles, surface objects, or other swimmers.
- Do not engage in extended breath holding activities underwater

* Consult safe use instructions of the pool slide manufacturer.

Appendix H

Safety Brochures and Education Programs

This appendix is not part of the American National Standard ANSI/APSP/ICC-5 2011. It is included for information only.

Consumer awareness information is available from the following sources:

- “The Sensible Way to Enjoy Your Inground Swimming Pool” Published by the Association of Pool & Spa Professionals (APSP)
- “Children Aren't Waterproof” Published by the APSP
- “Be Safety Aware” Published by the APSP
- “Layers of Protection” Published by the APSP
- “Pool and Spa Emergency Procedures for Infants and Children” Published by the APSP
- “Knowing How to Dive” Published by the APSP

Copies of the above brochures are available free from the APSP at 703-838-0083, ext. 301.

Also, visit APSP’s website at **www.APSP.org** and consult “Consumer Information.”

Safety Education Programs and Materials

Educational programs and materials (i.e., seminars, workshops, brochures, videos, instructional guides, etc.) are available from APSP, NSPF, other aquatic safety groups, and by private firms. As a means of communicating useful safety information to pool owners/operators and users, industry members are permitted to provide such information to owners/operators and to request or require owners/operators to sign a statement that they have received, read and will follow the guidelines.

APSP
2111 Eisenhower Avenue
Alexandria, VA 22314
703-838-0083
www.APSP.org

For a copy of the complete ANSI/APSP/ICC-5 2011 American National Standard for Residential Inground Swimming Pools contact:

**Association of Pool and Spa Professionals
2111 Eisenhower Avenue
Alexandria, VA 22314
Phone: (703) 838-0083
www.APSP.org**

**SELECTED SECTIONS EXTRACTED FROM
ANSI/NSPI-1 2003
AMERICAN NATIONAL STANDARD FOR PUBLIC SWIMMING POOLS**

**Standard for
Public Swimming Pools**

1.1 Public swimming pools. This standard covers public swimming pools to be used for bathing and operated by an owner, licensee, or concessionaire, regardless of whether a fee is charged for use.

1.1.1 Public swimming pools covered by this standard. Public swimming pools covered by this standard include Class A pools (pools used for competitive aquatic sports), Class B and Class C pools, (pools intended for public or semi-public recreational swimming), and Class F pools (for wading). (See article 3 for definitions.)

1.2 Variation in design. This standard provides specifications for the design, equipment, operation, warning signs, installation, sanitation, new construction, and renovation of public swimming pools. This standard permits variations in equipment, materials, and design to accommodate special needs and considerations and advances in technology and to provide the required quality, strength, durability, and safety for the intended use.

1.3 Renovation. (See appendix H, Glossary.) Renovation does not include ordinary maintenance. Only those items that are renovated shall adhere to this standard.

2 Normative references

The following standards contain provisions that, through reference in this text, constitute provisions of, this American National Standard. At the time of publication, the editions indicated were valid. All standards are subject to revision, and parties to agreements based on this American National Standard are encouraged to investigate the possibility of applying the most recent editions of the standards indicated below.

ANSI/ASME A112.19.8M-1987 (1996), *Suction fittings for swimming and wading pools, spas, hot tubs, and whirlpool bathtub appliances*¹

ANSI/ICC A 117.1 (2003), *Standard on accessible and useable buildings and facilities*²

ANSI/NEMA-MG1-1998, *Motors and generators*³

ANSI/NSF 14 (2003), *Plastics piping system components and related materials*⁴

ANSI/NSF 50 (2001), *Circulation system components and related materials for swimming pools, spas/hot tubs*⁵

ANSI Z21.56-2001/CSA 4.7-2001, *Gas fired pool heaters*⁶

ACI 302.1R-96 (1996), *Guide for concrete floor and slab construction*⁷

Americans with Disabilities Act (ADA) *Accessibility guidelines for buildings and facilities; recreation facilities*⁸

ASME A112.1.2 (2002), *Air gaps in plumbing systems*⁹

ASTM 1346-91 (2003), *Standard performance specification for safety covers and labeling require-*

¹ American National Standards Institute (ANSI), 25 West 43rd Street, New York, NY 10036, NY (212) 642-4900, www.ansi.org

² ANSI, previously listed

³ National Electrical Manufacturers Association (NEMA), 1300 N. 11th Street, Suite 1847, Rosslyn, V A 22209 (703) 841-3200, www.nema.org

⁴ NSF International, 789 N. Dixboro Rd., Ann Arbor, MI 48113 (734) 769-8010, www.nsf.org

⁵ NSF, previously listed

⁶ ANSI, previously listed

⁷ American Concrete Institute, 38800 Country Club Drive, Farmington Hills, MI 48331, (248) 848-3800, www.aci-int.org

⁸ U.S. Architectural and Transportation Barriers Compliance Board, 1331 F Street, NW, Suite 1000, Washington, DC 20004, (202) 272-0080, www.access-board.gov

⁹ American Society of Mechanical Engineers (ASME), 3 Park Avenue, 20th Floor, New York, NY 10016, (212) 591-8562, www.asme.org

ments for all covers for swimming pools, spas and hot tubs¹⁰

ASTM F2208-02, *Standard specification for pool alarms*¹¹

ANSI/NFPA 54-2002, *National fuel gas code*¹²
ANSI/NFPA 70-2002, *National electric code*¹³

UL 1995 (1999), *Standard for heating and cooling equipment*¹⁴

UL 1261 (2001), *Standard for electric water heaters for pools and tubs*¹⁵

3 Definitions

Public swimming pools are classified as follows for purposes of reference and application of this standard:

Class A pools - Class A pools are pools intended for use for accredited competitive aquatic events such as Federation Internationale de Natation Amateur (FINA), U.S.A. Swimming, U.S. Diving, National Collegiate Athletic Association (NCAA), National Federation of State High Schools Associations (NFSA), etc. The pool may also be used for recreation. Class A pools are covered unless otherwise noted in the body of the standard.

Class B pools - Class B pools are pools intended for public recreational swimming not otherwise classified. Class B pools are covered within the scope of this standard.

Class C pools - Class C pools are pools intended for use for apartments, condominiums, property owners associations, multi-family owned pools, etc. and are

¹⁰ ASTM International, 100 Barr Harbor Drive, W. Conshohocken, PA 19428, (610) 832-9585, www.astm.org

¹¹ ASTM, previously listed

¹² National Fire Protection Association (NFPA), 1 Batterymarch Park, Quincy, MA 02269 (617) 770-3000, www.nfpa.org

¹³ NFPA, previously listed

¹⁴ Underwriters Laboratories (UL), 333 Pfingsten Road, Northbrook, IL 60062, (847) 272-8800, www.ul.com

¹⁵ UL, previously listed

covered within the scope of this standard. Pools operated solely for and in conjunction with lodgings such as hotels and motels are also covered within the scope of this standard.

Class D pools -Class D pools are not covered within the scope of this standard. Class D pools are operated for special purposes, including but not limited to wave action pools, activity pools, leisure rivers, vortex pools, and sand bottom pools.

Class E pools -Class E pools are pools used for physical therapy and are above 86°F (30 OC) and are not covered within the scope of this standard.

Class F pools -Class F pools are wading pools and are covered within the scope of this standard as set forth in 6.9 and 8.4.2 and as noted in other sections of the standard.

4 Code compliance

4.1 Codes. Pools covered by this standard shall be constructed and operated to comply with all local, state, and federal codes governing safety and environmental regulations.

5 General design

5.1 Plans and permits. Prior to construction, rehabilitation, or alteration of a permanently installed public swimming pool, plans and specifications shall be submitted to the authority (state or local) for review, approval, and issuance of a permit to construct or rehabilitate as required by the authority having jurisdiction.

5.2 Materials. Swimming pools and all appurtenances thereto shall be constructed of materials that are nontoxic to humans and the environment; that are generally or commonly regarded to be impervious and enduring; that will withstand the design stresses; and that will provide a watertight structure with a smooth and easily cleaned surface without cracks or joints, excluding structural joints, or to which a smooth, easily cleaned surface/finish is applied or attached.

5.2.1 Selection of materials. Clean sand or similar material, if used in a beach pool environment, shall be used only over an impervious surface. The sand area shall be designed and controlled so that the circulation system, maintenance, safety, sanitation, and operation of the overall pool are not adversely affected.

5.3 Structural design. The structural design shall be in accordance with accepted engineering practices.

5.4 Freeze protection. In climates subject to freezing temperatures, the pool shell and appurtenances, piping, filter system, pump and motor, and other components shall be designed and constructed to facilitate protection from damage due to freezing.

5.5 Surface condition. The surfaces within the pool intended to provide footing for users shall have a slip-resisting surface and shall not cause injury to the feet during normal use.

5.6 Colors and finishes. The colors, patterns, or finishes of the pool interior shall not obscure objects or surfaces within the pool.

5.7 Accessibility for persons with disabilities. For Americans with Disabilities Act (ADA) requirements for accessibility for persons with disabilities into public swimming pools, see *ADA Accessibility guidelines for buildings and facilities, recreation facilities* (ADAAG).

6 Dimensional design

6.1 Perimeter shape. This standard is not intended to regulate the perimeter shape of swimming pools.

It is the designer's responsibility to take into account the effect a given shape will have on the safety of the occupants and required circulation to ensure sanitation. All other dimensions, unless otherwise specified, should allow ± 2 inches (51 mm) tolerance.

6.1.1 There shall be no protrusions, extensions, means of entanglement, or obstructions in the swimming pool areas that may cause the entrapment or injury of the user.

6.2 Allowable construction tolerances. These construction tolerances are not applicable to Class A pools.

6.2.1 Finished pool dimensions shall be held within the following construction tolerances as shown in table 1.

6.3 Floor slope. Floor slopes shall be in compliance with 6.3.1 through 6.3.5, except the requirements by the ADA Accessibility guidelines (ADAAG).

6.3.1 All pool floors shall be sloped to the drain.

6.3.2 The slope of the floor in the shallow area shall not exceed 1 foot in 10 feet in Class C pools or 1 foot in 12 feet in Class B pools in any direction to the point of the first slope change, if a slope change exists.

6.3.3 The point of the first slope change shall be defined as the point at which the floor slope exceeds 1 foot in 10 feet in Class C pools or 1 foot in 12 feet in Class B pools.

Table 1- Construction tolerances

Design requirements	Construction tolerance allowed
Length – overall	± 3 in. (76 mm)
Width – overall	± 3 in. (76 mm)
Depth – deep area, including diving area	± 3 in. (76 mm)
Depth – shallow area	± 2 in. (51 mm)
Step treads & risers	$\pm 1/2$ in. (13 mm)
Waterline – pools with adjustable weir skimmers	$\pm 1/4$ in. (6 mm)
Waterline – pools with nonadjustable skimming systems (gutters)	$\pm 1/8$ in. (3 mm)
Wall slopes	± 3 degrees
All dimensions not otherwise specified in this standard	± 2 in. (51 mm)
Competitive pools – Class A pools – All dimensional requirements	As governed by sanctioning authority

6.3.4 The slope of the floor from the point of the first slope change to the deep area shall not exceed 1 foot in 3 feet.

6.3.5 Walls. Where walls join the floor the transitional point or profile shall comply with the following:

-Walls may intersect with the floor at an angle or a transition profile.

-At water depths between 3 feet to 5 feet (91 cm to 152 cm) the maximum radius shall be 2 feet 3 inches (69 cm).

-At water depths of 3 feet (91 cm) or less a transitional radius shall not exceed 6 inches (15 cm) and shall be tangent to the wall and may be tangent to or intersecting the floor.

-At water depths greater than 3 feet (91 cm) a transitional radius shall be tangent to the wall at a point no less than 2 feet and 6 inches (76 cm) below the water surface and may progressively increase from 6 inches (15 cm) to a value capable of being tangent to or intersecting the floor.

6.4 Water depths for swimming areas shall be a minimum depth of 3 feet (91 cm) unless the authority having jurisdiction specifies otherwise.

6.4.1 Class A pools shall be designed and constructed to provide the dimensions specified by Federation Internationale de Natation Amateur (FINA), U.S.A. Swimming, U.S. Diving, or other appropriate sanctioning body.

6.5 Diving. This standard does not cover diving requirements for Class A pools. This standard covers diving requirements for Class B and Class C pools.

6.5.1 When diving equipment is installed, it shall conform to the specifications set forth in 7.2.1 through 7.2.5.6. Equipment shall be located in the diving area of the pool on the appropriate ANSI/NSPI pool type (or other water envelopes specified by the diving equipment manufacturer) in accordance with the manufacturer's installation instructions and the minimum dimensions as shown in figure 1. Competitive diving equipment shall not be installed on Class B and Class C pools.

6.6 The manufacturer of the diving equipment shall specify minimum water envelopes for its products. They may refer to the water envelope type of their choice by dimensionally relating their products to Point "A" on that water envelope. Point "A" as shown in figure 1 is designated as the point of origin on the water surface for the water envelope dimension.

6.6.1 Point A is a point located on the water surface of pool water envelopes.

6.6.2 Point A is a construction location nearest the deep end wall where the minimum water depth D_1 is satisfied.

6.6.3 Point A, as shown in figure 1 and table 2, shall be the referenced point of origin for all dimensions defining a minimum water envelope.

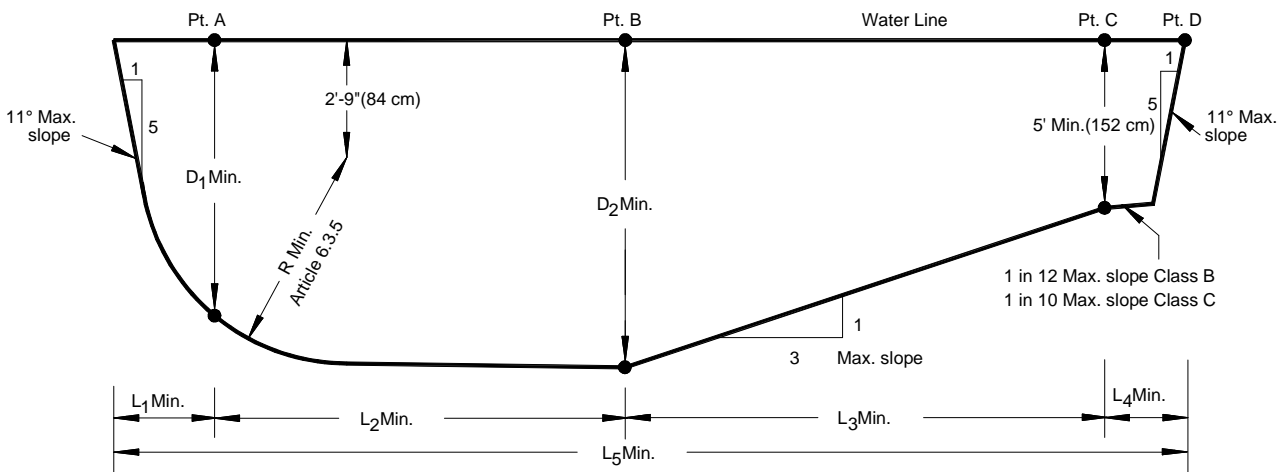

Figure 1 – Construction dimensions for water envelopes for Class B and Class C pools

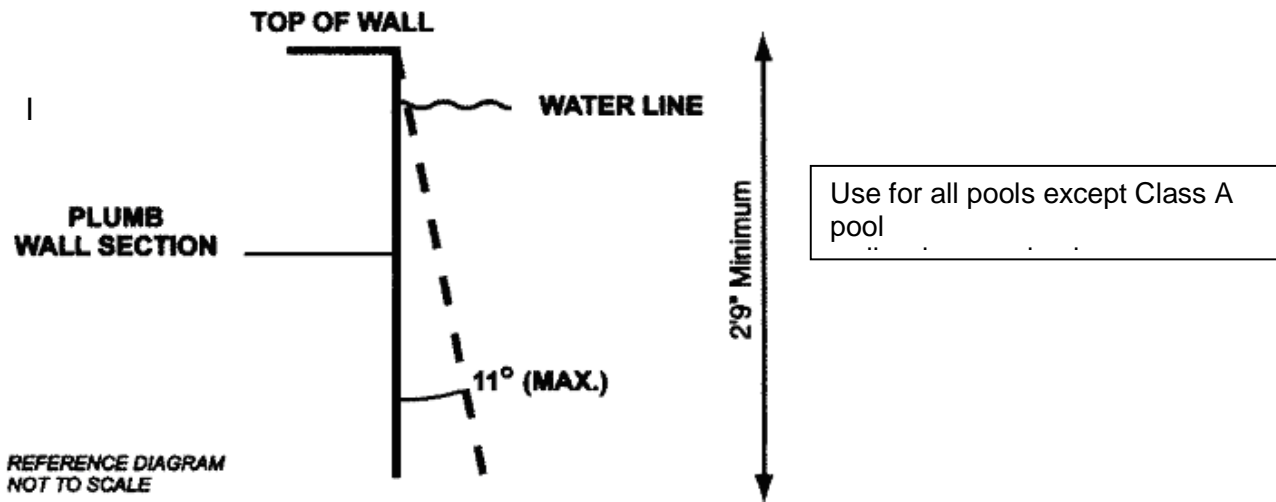

Figure 2 – Maximum allowable wall slope

Table 2 – Minimum water envelopes

Pool type	Minimum dimensions								Minimum width of pool at:		
	D ₁	D ₂	R	L ₁	L ₂	L ₃	L ₄	L ₅	Pt. A	Pt. B	Pt. C
VI	7'-0" (213 cm)	8'-6" (259 cm)	5'-6" (168 cm)	2'-6" (76 cm)	8'-0" (244 cm)	10'-6" (320 cm)	7'-0" (213 cm)	28'-0" (853 cm)	16'-0" (488 cm)	18'-0" (549 cm)	18'-0" (549 cm)
VII	7'-6" (229 cm)	9'-0" (274 cm)	6'-0" (183 cm)	3'-0" (91 cm)	9'-0" (274 cm)	12'-0" (366 cm)	4'-0" (122 cm)	28'-0" (853 cm)	18'-0" (549 cm)	20'-0" (610 cm)	20'-0" (610 cm)
VIII	8'-6" (259 cm)	10'-0" (305 cm)	7'-0" (213 cm)	4'-0" (122 cm)	10'-0" (305 cm)	15'-0" (457 cm)	2'-0" (61 cm)	31'-0" (945 cm)	20'-0" (610 cm)	22'-0" (671 cm)	22'-0" (671 cm)
IX	11'-0" (335 cm)	12'-0" (366 cm)	8'-6" (259 cm)	6'-0" (183 cm)	10'-6" (320 cm)	21'-0" (640 cm)	0 (0 cm)	37'-6" (11.4 m)	22'-0" (671 cm)	24'-0" (732 cm)	24'-0" (732 cm)

Table 3 – Maximum user load

Pool/Deck area	Shallow instructional or wading areas	Deep area (not including the diving area)	Diving area (per each diving board)
Pools with minimum deck area (See 7.1.6 through 7.1.6.1.)	15 sq. ft. per user (1.35 m ² per user)	20 sq. ft. per user (1.8 m ² per user)	300 sq. ft. per user (27 m ² per user)
Pools with deck area at least equal to water surface area	12 sq. ft. per user (1.08 m ² per user)	15 sq. ft. per user (1.35 m ² per user)	300 sq. ft. per user (27 m ² per user)
Pools with deck area at least twice the water surface area	8 sq. ft. per user (0.72 m ² per user)	10 sq. ft. per user (0.9 m ² per user)	300 sq. ft. per user (27 m ² per user)

6.7 Rest ledges. Rest Ledges along the pool walls are permitted. They must be not less than 4 feet (122cm) below the water surface. If a ledge is provided it shall be at least 4 inches (10 cm) wide and not more than 8 inches (20 cm) wide.

6.8 Maximum user load. The maximum user load of Class B or Class C pools shall be in accordance with table 3.

6.9 Wading pools. A wading pool shall be a separate pool with an independent circulation system and physically separated from the main pool as described in 6.9.1 through 6.9.4.

6.9.1 Areas where the water depth at the edge of the pool exceeds 9 inches (23 cm) shall be considered non-entry areas and must be protected by natural or artificial barriers.

6.9.2 Floors of wading pools shall be uniform and sloped to drain with a minimum slope of 1 foot in 12 feet (30 cm in 360 cm).

6.9.3 The maximum water depth shall be 18 inches (46 cm).

6.9.4 The Maximum distance from the top of the deck to the water line shall not exceed 6 inches (15 cm).

7 Decks and deck equipment.

7.1 Decks shall comply with 7.1.1 through 7.1.17 as applicable.

7.1.1 Deck(s) shall be designed and installed in accordance with the engineering methods required by the authority having jurisdiction.

7.1.1.1 In the absence of specific local requirements, a concrete deck shall be designed and constructed in accordance with the recommended practices of the most recent edition of American Concrete Institute (ACI) Standard 302.1R-96, *Guide for concrete floor and slab construction*, or in accordance with the requirements of the local authority, the authority having jurisdiction, or both. The deck shall be designed and constructed to meet the applicable requirements of the Americans with Disabilities Act.

7.1.2 Decks, ramps, coping, and similar step surfaces shall be slip resisting and cleanable.

7.1.3 Special features in or on deck(s) such as markers, brand insignias, or similar materials shall be slip resisting.

7.1.4 Step risers for the deck shall be uniform and have a minimum height of 3-3/4 inches (9.5 cm) and a maximum height of 7-1/2 inches (19 cm). A handrail shall be provided for stairs having three or more risers. The minimum tread distance from front to back shall be 11 inches (28 cm).

7.1.5 The deck or unobstructed access shall be provided at a minimum of 65% of the pool perimeter to meet the requirement of the 10/20 rule. (See appendix H, Glossary.)

7.1.5.1 A minimum 4 feet (122 cm) deck width shall be provided on the sides and rear of any diving equipment. A deck clearance of 3 feet (91 cm) shall be provided around all other deck equipment.

7.1.6 The minimum slope of the deck(s) shall be 1/8 inch per 1 foot (3.2 mm per 304.8 mm) for textured, hand-finished concrete decks; 1/4 inch per 1 foot (6.4 mm per 304.8 mm) for exposed aggregate concrete decks; 1/2 inch per 1 foot (12.7 mm per 304.8 mm) for indoor/outdoor carpeting decks; and 3/8 inch per 1 foot (9.5 mm per 304.8 mm) for brick and heavy textures finishes, unless an alternate drainage method is provided that prevents the accumulation of pooling of water. (See table 4.)

7.1.6.1 Decks shall be sloped so that standing water shall be no deeper than 1/8 inch (3.2 mm), 20 minutes after the cessation of the addition of water to the deck.

NOTE -Two stacked U.S. quarters can be used to measure the depth. Water should not cover the quarters.

7.1.7 The maximum slope of all decks, other than wood decks, shall be 1/2 inch per foot (12.7 mm per 304.8 mm) except for ramps.

7.1.7.1 The maximum slope for wood decks shall be 1/8 inch per 1 foot (3.2 mm per 304.8 mm).

7.1.7.2 Gaps shall be required between deck boards in wood decks and shall be consistent with approved engineering methods with respect to the type of wood used and shall not cause a tripping hazard.

7.1.8 The maximum open gap between pool decks and adjoining decks or walkways, including joint material, shall be 3/4 inch (19.1 mm). The difference in vertical elevation between the pool deck and the adjoining sidewalk shall be 1/4 inch (6.4 mm) unless it conforms to 7.1.4.

7.1.9 Construction joints where the pool coping meets the concrete deck(s) shall be watertight.

7.1.10 Construction joints where the pool coping meets the concrete deck(s) shall be installed to protect the coping and its mortar bed from damage as a result of the anticipated movement of adjoining deck(s).

7.1.11 Control joints in deck(s) shall be provided to minimize visible cracks outside the control joints due to imposed stresses and/or movement of the slab.

7.1.12 Areas where decks join existing concrete work shall be protected by an expansion joint to protect the pool from the pressures of relative movements.

7.1.13 The edges of all decks shall be radiused, tapered, or otherwise designed to eliminate sharp corners.

7.1.14 Pressure tests. A pressure test shall be maintained throughout the deck pour and in accordance with 8.4.

7.1.15 Valves installed in or under any deck(s) shall have access provided for operation, service, and maintenance. Access covers shall be provided.

7.1.16 Hose bib(s), with a cross connection control to prevent backflow, shall be provided for rinsing down the entire deck and shall be in accordance with the authority having jurisdiction.

7.1.17 Water-powered devices (such as water-powered lifts) shall have a dedicated hose bib (water source).

7.2 Deck equipment. Deck equipment including diving facilities and starting blocks shall comply with 7.2.1 through 7.4 as applicable.

Table 4 – Typical minimum drainage slope

Surface	Typical minimum drainage slope (inch per foot)
Textured, hand-finished concrete	1/8 in. (3.2)
Exposed aggregate	1/4 in. (6.4 mm)
Carpet	1/2 in. (12.7 mm)
Brick and heavy textures finished	3/8 in. (9.5 mm)

7.2.1 A minimum 4 feet (122 cm) deck width shall be provided on the sides and rear of any diving equipment.

7.2.2 Starting blocks. Starting blocks are intended for competitive swimming and shall conform to Federation Internationale de Natation Amateur (FINA), U.S.A. Swimming, National Collegiate Athletic Association (NCAA), or National Federation of State High Schools Associations (NFSHSA).

7.2.3 There shall be a completely unobstructed distance of 14 feet (427 cm) above the tip of the diving board or as specified by the diving equipment manufacturer or the authority having jurisdiction.

7.2.4 Public pools with diving equipment of 1 meter (39 inches) or greater in height, or pools designed for springboard or platform diving, shall comply with the dimensional design requirements of Federation Internationale de Natation Amateur (FINA), U.S. Diving, National Federation of State High Schools Association (NFSHSA) or the appropriate sanctioning body.

7.2.5 Diving equipment. Diving equipment shall be installed in accordance with the manufacturer's specifications.

7.2.5.1 The diving equipment manufacturer shall affix a label to the diving equipment.

7.2.5.2 A label shall be permanently affixed to the diving equipment or jump board and shall include but not be limited to the following:

-The minimum water envelope required for each diving board and diving stand combination,

-Manufacturer's name and address,

-Manufacturer's identification and date of manufacture, and

-The maximum weight of the user, visibly located on the diving board.

7.2.5.3 The diving equipment manufacturer shall provide diving equipment use instructions.

7.2.5.4 Diving equipment shall have slip-resisting tread surfaces.

7.2.5.5 Supports for diving equipment. Supports, platforms, stairs, and ladders for diving equipment shall be designed to carry the anticipated loads. Stairs and ladders shall be of corrosion-resisting material and shall be easily cleanable and with slip-resisting tread. All diving stands higher than 21 inches (53 cm) measured from the deck to the top butt end of the board shall be provided with stairs and/or a ladder. Step treads shall be self-draining.

7.2.5.6 Diving equipment 1 meter high (39 inches) or greater shall be provided with a top guard rail, which shall be at least 30 inches (76 cm) above the diving board and extend to the edge of the pool wall and to the deck surface.

7.3 Swimming pool slides. Swimming pool slides, when installed, shall comply with the requirements of the U.S. Consumer Product Safety Commission (CPSC) as published in the *Code of Federal Regulations*, 16 CFR, Part 1207. The manufacturer shall provide installation and use instructions with each slide. Each slide shall be installed in accordance with the manufacturer's instructions.

7.4 Play/water activity equipment. When installed, play/water activity equipment shall be installed in accordance with manufacturer's instructions.

For a copy of the complete ANSI/NSPI-1 2003 American National Standard for Public Swimming Pools contact:

**National Spa and Pool Institute
2111 Eisenhower Avenue
Alexandria, VA 22314
Phone: (703) 838-0083
Fax: (703) 549-0493
www.nspi.org**